

**KEB**





# COMBIVERT F5

INSTRUCTIONS FOR USE | INSTALLATION F5 HOUSING B

Translation of the original manual  
Document 20120297 EN 1M

This manual describes the KEB COMBIVERT F5. Particular attention is paid to the installation, the connection as well as the basic operation. Due to the various application and programming possibilities, the application-specific connection and/or wiring diagram, the parameter adjustment as well as instructions to the start-up are to be taken from the documentation of the machine manufacturer.

A list of instruction manuals and documents giving assistance for the construction, documentation and service is provided at the end of this manual. The safety and warning notes listed in this instruction manual as well as in other documentation must be observed at any rate to ensure a safe operation. Non-observance of the safety instructions leads to the loss of any liability claims. The safety and warning instructions specified in this manual do not lay claim on completeness. KEB reserves the right to change/adapt specifications and technical data without prior notice. The used pictograms have following significance:

	Danger Warning Caution	Is used, if life or health of the user are endangered or substantial damage to property can occur.
	Attention observe at all costs	Is used, if a measure is necessary for safe and trouble-free operation.
	Information Aide Tip	Is used, if a measure simplifies the handling or operation of the unit.

The information contained in the technical documentation, as well as any user-specific advice in spoken and written and through tests, are made to best of our knowledge and information about the application. However, they are considered for information only without responsibility. This also applies to any violation of industrial property rights of a third-party.

Inspection of our units in view of their suitability for the intended use must be done generally by the user. Inspections are particularly necessary, if changes are executed, which serve for the further development or adaption of our products to the applications (hardware, software or download lists). Inspections must be repeated completely, even if only parts of hardware, software or download lists are modified. Original spare parts and authorized accessories by the manufacturer serve as security. The use of other parts excludes liability for the damages which can result from it. Application and use of our units in the target products is outside of our control and therefore exclusively in the area of responsibility of the user. Repairs may only be carried out by the manufacturer or an authorised repair agency. Unauthorised opening and tampering may lead to bodily injury and property damage and may entail the loss of warranty rights.

<b>1. Safety and Operating Instructions.....</b>	<b>4</b>	<b>A. Annex A.....</b>	<b>27</b>
<b>2. Product Description .....</b>	<b>5</b>	A.1 Overload characteristic.....	27
2.1 Intended use.....	5	A.2 Calculation of the motor voltage.....	27
2.2 Unit identification .....	5	A.3 Maintenance.....	27
2.3 Technical data .....	6	A.4 Storage.....	28
2.3.1 230 V class.....	6	A.5 Changing the response threshold of the braking transistor.....	29
2.3.2 400V class .....	7	<b>B. Annex B.....</b>	<b>30</b>
2.4 Dimensions and terminals.....	8	B.1 CE Marking.....	30
<b>3. Installation and Connection .....</b>	<b>9</b>	B.2 UL Marking .....	30
3.1 Control cabinet installation .....	9	B.3 Additional Manuals .....	32
3.2 EMC-conform Installation .....	9		
3.3 Connection of Power Circuit.....	10		
3.3.1 Terminal Strip X1A.....	10		
3.3.2 Wiring instructions .....	10		
3.3.3 Mains connection .....	11		
3.3.4 Motor connection.....	12		
3.3.5 Connection of the temperature monitoring .....	12		
3.3.6 Connection of a braking resistor with fire prevention.....	13		
3.4 Control Board Basic .....	14		
3.4.1 X2A Control Terminal Strip .....	14		
3.4.2 Connection of the control terminal strip... 15	15		
3.5 Control board Compact/General/Application without encoder interface.....	16		
3.5.1 X2A Control Terminal Strip .....	16		
3.5.2 Connection of the control terminal strip... 17	17		
<b>4. Operation of the Unit.....</b>	<b>18</b>		
4.1 Operation Accessories .....	18		
4.1.1 With HSP5 cable and without operator	18		
4.1.2 Digital operator (part number 00F5060-1000) .....	18		
4.1.3 Interface operator (part number 00F5060-2000).....	18		
4.1.4 Remote control .....	19		
4.1.5 Other operators .....	19		
4.2 Keyboard Operation .....	19		
4.2.1 Parameter numbers and values .....	19		
4.2.2 Resetting error messages .....	20		
4.2.3 Password Input.....	20		
<b>5. Parameter Descriptions .....</b>	<b>21</b>		
5.1 Basic/Compact/General/Application without encoder interface .....	21		

## 1. Safety and operating instructions



### Safety and operating instructions for drive converters

(in conformity with the Low-Voltage Directive 2006/95/EC)

#### 1. General

In operation, drive converters, depending on their degree of protection, may have live, uninsulated, and possibly also moving or rotating parts, as well as hot surfaces.

In case of inadmissible removal of the required covers, of improper use, wrong installation or maloperation, there is the danger of serious personal injury and damage to property.

For further information, see documentation.

All operations serving transport, installation and commissioning as well as maintenance are to be carried out by skilled technical personnel (Observe IEC 364 or CENELEC HD 384 or DIN VDE 0100 and IEC 664 or DIN/VDE 0110 and national accident prevention rules!).

For the purposes of these basic safety instructions, „skilled technical personnel“ means persons who are familiar with the installation, mounting, commissioning and operation of the product and have the qualifications needed for the performance of their functions.

#### 2. Specified application

Drive converters are components designed for inclusion in electrical installations or machinery.

In case of installation in machinery, commissioning of the drive converter (i.e. the starting of normal operation) is prohibited until the machinery has been proved to conform to the provisions of the directive 2006/42/EC (Machinery Directive). Account is to be taken of EN 60204.

The drive converters meet the requirements of the Low-Voltage directive 2006/95/EC. The harmonized standards of the series EN 61800-5-1 for the drive converters were used.

The technical data as well as information concerning the supply conditions shall be taken from the rating plate and from the documentation and shall be strictly observed.

#### 3. Transport, storage

The instructions for transport, storage and proper use shall be complied with.

The climatic conditions shall be in conformity with EN 61800-5-1.

#### 4. Installation

The installation and cooling of the appliances shall be in accordance with the specifications in the pertinent documentation.

The drive converters shall be protected against excessive strains. In particular, no components must be bent or isolating distances altered in the course of transportation or handling. No contact shall be made with electronic components and contacts.

Drive converters contain electrostatic sensitive components which are liable to damage through improper use. Electric components must not be mechanically damaged or destroyed (potential health risks).

#### 5. Electrical connection

When working on live drive converters, the applicable national accident prevention rules (e.g. VBG 4) must be complied with.

The electrical installation shall be carried out in accordance with the relevant requirements (e.g. cross-sectional areas of conductors, fusing, PE connection). For further information, see documentation.

Instructions for the installation in accordance with EMC requirements, like screening, earthing, location of filters and wiring, are contained in the drive converter documentation. They must always be complied with, also for drive converters bearing a CE marking. Observance of the limit values required by EMC law is the responsibility of the manufacturer of the installation or machine.

#### 6. Operation

Installations which include drive converters shall be equipped with additional control and protective devices in accordance with the relevant applicable safety requirements, e.g. act respecting technical equipment, accident prevention rules etc.. Changes to the drive converters by means of the operating software are admissible.

After disconnection of the drive converter from the voltage supply, live appliance parts and power terminals must not be touched immediately because of possibly energized capacitors. In this respect, the corresponding signs and markings on the drive converter must be respected.

During operation, all covers and doors shall be kept closed.

#### 7. Maintenance and servicing

The manufacturer's documentation shall be followed.

**KEEP SAFETY INSTRUCTIONS IN A SAFE PLACE!**

## 2. Product description

### 2.1 Intended use

The frequency inverter KEB COMBIVERT F5 serves exclusively for the control and regulation of asynchronous motors. The operation of other electric consumers is prohibited and can lead to the destruction of the unit.

Frequency inverters are components which are intended for the installation in electric systems or machines.

### 2.2 Unit identification

09	F5	B	1	B	3	9	0	0	
Cooling									
A: Heat sink						B: Flat rear			
Encoder interface									
0: none									
Switching frequency; short time current limit; overcurrent limit									
5: 4 kHz; 150%; 180%			9: 4 kHz; 180%; 216%						
A: 8 kHz; 180%; 216%			B: 16 kHz; 180%; 216%						
Input identification									
0: 1-phase 230 VAC or DC supply									
1: 3-phase 230 VAC or DC supply									
2: 1/3-phase 230 VAC or DC supply									
3: 3-phase 400 VAC or DC supply									
6: 1-phase 230 V AC									
Housing type B									
Accessories									
1: Braking transistor									
B: such as 1 but with safety relays									
3: Braking transistor and integrated filter									
D: such as 3 but with safety relays									
Control type									
B: BASIC <sup>1)</sup>									
C: COMPACT									
Series F5									
Inverter size									

- At control type "BASIC" (xxF5Bxx-xxxx) an output frequency of up to 1600 Hz is possible by changing the operating mode. These devices are subject to export authorisation according to entry 3A225 Annex I of the Dual-Use Regulation. □

## Product description

### 2.3 Technical data

#### 2.3.1 230 V class

Inverter size		05		07		09		10	
Housing size		B		B		B		B	
Phases		1	3	1	3	1	3	1	3
Output rated power	[kVA]	0,9		1,6		2,8		4	
Max. rated motor power	[kW]	0,37		0,75		1,5		2,2	
Output rated current	[A]	2,3		4		7		10	
Output rated current UL	[A]	2,3		4,1		6		9,6	
Max. short time current	[A]	4,1		7,2		12,6		18	
OC-tripping current	[A]	5		8,6		15,1		21,6	
Input rated current	[A]	4,6	3,2	8	5,6	14	9,8	20	14
Rated input current UL	[A]	4	2,8	8	5,7	14	9,5	20	13,5
Max. permissible mains fuse (type gG)	[A]	16	16	20	16	20	16	25	20
Rated switching frequency	[kHz]	16		16		16		8	
Max. switching frequency	[kHz]	16		16		16		16	
Power loss at nominal operating	[W]	50		65		90		105	
Power loss at DC operating	[W]	48		60		80		90	
Minimum braking resistor	[Ω]	56		56		47		33	
Typically braking resistor	[Ω]	180		180		100		68	
Maximal braking current	[A]	7,5		7,5		9,5		12	
Input rated voltage	[V]	230 (UL= 240)							
Input voltage range U <sub>in</sub>	[V]	180...260 ±0							
Mains frequency	[Hz]	50...60 ±2							
Output voltage	[V]	3 x 0...U <sub>in</sub>							
Output frequency	<sup>1)</sup> [Hz]	0...400							
Max. motor line length shielded (4 kHz)	[m]	30		100		100		100	
Max. motor line length shielded (8 kHz)	[m]	20		50		100		100	
Max. motor line length shielded (16 kHz)	[m]	10		20		40		100	

1) The actual output frequency is depending on the parameterisation. The output frequency is to be limited in such way that 1/10 of the switching frequency is not exceeded.

- At control type "BASIC" (xxF5Bxx-xxxx) an output frequency of up to 1600 Hz is possible by changing the operating mode. This devices are subject to export authorisation according to entry 3A225 Annex I of the Dual-Use Regulation and they are labeled accordingly on the delivery note.
- The output frequency is limited to max. 599 Hz at control type „COMPACT“ (xxF5Cxx-xxxx). This devices are not subject to export authorisation.



Site altitude maximal 2000m above sea level. With site altitudes over 1000m a derating of 1% per 100m must be taken into consideration.

### 2.3.2 400 V class

Inverter size		05	07	09	10	12
Housing size		<b>B</b>				
Phases		<b>3</b>				
Output rated power	[kVA]	0,9	1,8	2,8	4	6,6
Max. rated motor power	[kW]	0,37	0,75	1,5	2,2	4
Output rated current	[A]	1,3	2,6	4,1	5,8	9,5
Output rated current UL	[A]	1	1,8	3,4	4,8	7,6
Max. short time current	[A]	2,3	4,7	7,4	10,4	17
OC-tripping current	[A]	2,8	5,6	8,9	12,5	21
Input rated current	[A]	1,8	3,6	6	8	13
Rated input current UL	[A]	1,6	2,5	4,8	6,7	10,6
Max. permissible mains fuse (type gG)	[A]	16	16	16	16	20
Rated switching frequency	[kHz]	16	16	8	8	4
Max. switching frequency	[kHz]	16	16	16	16	4
Power loss at nominal operating	[W]	60	90	80	120	150
Power loss at DC operating	[W]	58	87	75	110	135
Minimum braking resistor	[Ω]	390	120	120	82	82
Typically braking resistor	[Ω]	620	620	390	270	150
Maximal braking current	[A]	2,2	7,5	7,5	10	10
Input rated voltage	[V]	400 (UL= 480)				
Input voltage range $U_{in}$	[V]	305...528 ±0				
Mains frequency	[Hz]	50...60 ±2				
Output voltage	[V]	3 x 0... $U_N$				
Output frequency	<sup>1)</sup> [Hz]	0...400				
Max. motor line length shielded (4 kHz)	[m]	10	10	100	100	50
Max. motor line length shielded (8 kHz)	[m]	8	8	30	50	-
Max. motor line length shielded (16 kHz)	[m]	4	5	10	10	-

1) The actual output frequency is depending on the parameterisation. The output frequency is to be limited in such way that 1/10 of the switching frequency is not exceeded.

- At control type "BASIC" (xxF5Bxx-xxxx) an output frequency of up to 1600 Hz is possible by changing the operating mode. This devices are subject to export authorisation according to entry 3A225 Annex I of the Dual-Use Regulation and they are labeled accordingly on the delivery note.
- The output frequency is limited to max. 599 Hz at control type „COMPACT“ (xxF5Cxx-xxxx). This devices are not subject to export authorisation.



With input rated voltage of 480 Vac no braking resistor shall be connected at control type "BASIC". The operating threshold of the braking resistor ( $P_n.69$ ) must be adjusted at least to 770 Vdc for all other controls (see annex).

# Product description

## 2.4 Dimensions and Terminals

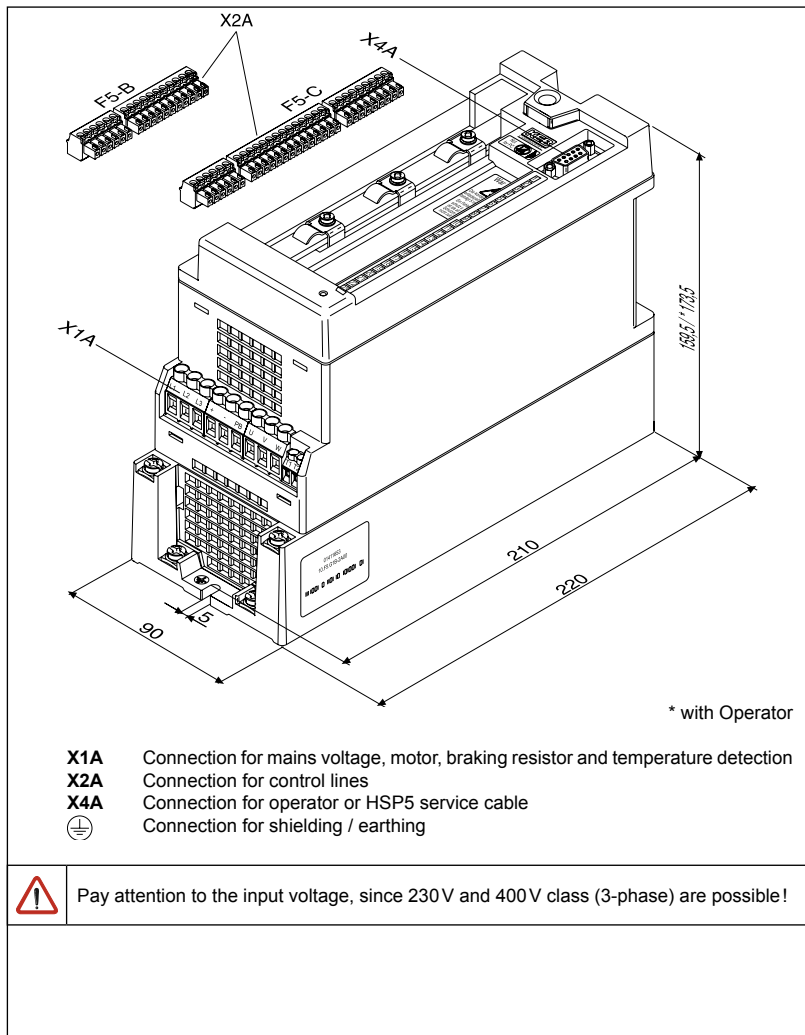



## 3. Installation and Connection

### 3.1 Control cabinet installation

<p>Protective system (EN 60529) IP20                  Operation temperature -10...45 °C (14...113 °F)                  Storage temperature -25...70 °C (-13...158 °F)                  Max. heat sink temperature 90 °C (194 °F)                  Climatic category (EN60721-3-3) 3K3                  Environment (IEC 664-1) Pollution degree 2                  Vibration/shock (EN60721-3-3) 3M1;                  German. Lloyd Part 7-3; Train EN50155                  Gas: 3C2; solids: 3S2</p> <p>Contamination (EN60721-3-3)</p> <p>The flat-rear design requires cooling measures by the machine builder. This can be in the best case no further measure at all (e.g. at cyclic operation with down times) up to the dissipation of the entire, indicated heat loss at rated operation.</p>	<p>Installation position and min. distances</p>
---	---

### 3.2 EMC-conform Installation



- Always apply the shielding of motor and control cables over a large contact surface on both sides.
- Distance between control and power cables at least 10...20 cm (4...8 inch).
- Lay motor and power cable separately.
- If it cannot be avoided, cross control and power cables in a right angle.
- Install all cables as close as possible to the mounting plate - ideal in a metal cable duct.
- Mount COMBIVERT well conducting with the mounting plate. Remove the paint beforehand.

You can find further instructions regarding the EMC-conform wiring in the Internet at KEB.

# Installation and Connection



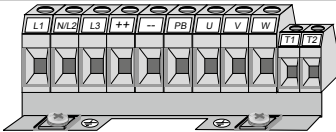
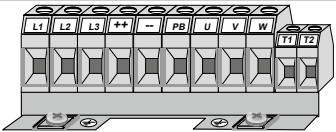

## 3.3 Connection of Power Circuit

### 3.3.1 Terminal Strip X1A

	
Terminal strip X1A/ 230 V class suitable for	Terminal strip X1A/ 400 V class suitable for
<ul style="list-style-type: none"> <li>• 180...260 VAC / 1-phase (L1/N)</li> <li>• 180...260 VAC / 3-phase (L1, L2, L3)</li> <li>• DC supply 250...370VDC (++, - -)</li> </ul>	<ul style="list-style-type: none"> <li>• 305...528 VAC / 3-phase (L1, L2, L3)</li> <li>• DC supply 420...720 VDC (++, - -)</li> </ul>
<ul style="list-style-type: none"> <li>• ++, PB      Braking resistor</li> <li>• U, V, W      Motor</li> <li>• T1, T2      Temperature sensor / switch (see chapter 3.3.6)</li> <li>•       Protective earth connection</li> </ul>	

Permissible cable cross-sections and tightening torques of the terminals		
Terminals	Perm. conductor cross-section	Tightening torque
L1...W	0.2...6 mm <sup>2</sup> (AWG 24-10)	0.6 Nm (5 lb inches)
T1, T2	0.1...2.5 mm <sup>2</sup> (AWG 30-14)	0.6 Nm (5 lb inches)
	PE Screw M4	1.3 Nm (11.5 lb inches)

### 3.3.2 Wiring instructions

	Absolutely observe the connecting voltage of the KEB COMBIVERT. A 230V-unit will be immediately destructed on a 400V-power supply.
	Never exchange the mains and motor cables.
	Some countries demand that the PE-terminal is directly connected to the terminal box (not over the mounting plate).
	Separate supply of the control Without further cooling measure a separate supply of the control is not permissible during a longer period, because the interior fan is not controlled here. The occurring heat accumulation causes an accelerated aging of the capacitors and thus for a reduction of the economic life time.

## 3.3.3 Mains connection

<p>Mains connection 230 V 1-phase</p> <p>1 x 180...260 Vac</p>	<p>Mains connection 230 V 3-phase</p> <p>3 x 180...260 Vac</p>
<p>Protection</p> <ul style="list-style-type: none"> <li>• Fuse (see chapter 2.3) or</li> <li>• power protective switch</li> <li>• at DC-supply pay attention to the permissible voltage range of the fuses</li> </ul>	<p>Mains connection 400 V 3-phase</p> <p>3 x 305...528 Vac</p>
<p>DC-connection 230 V-class</p> <p>250...370 Vdc</p>	<p>DC-connection 400 V-class</p> <p>420...720 Vdc</p>
	<p>This product can cause a d.c. current in the protective conductor. Where a residual current device (RCD) is used for protection in case of direct or indirect contact, only an RCD of Type B is allowed on the supply side of this product. Otherwise, another protective measure shall be applied, such as separation from the environment by double or reinforced insulation, or isolation from the supply system by a transformer.</p>

# Installation and Connection

## 3.3.4 Motor connection

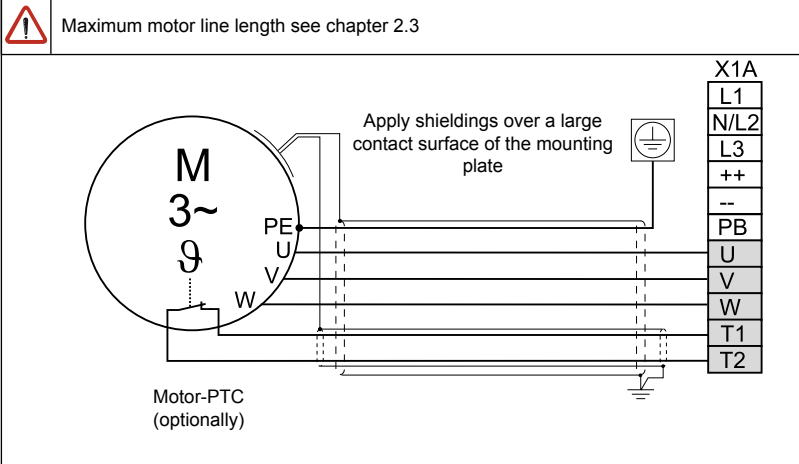

## 3.3.5 Connection of the temperature monitoring

- Terminals T1, T2
- Tripping resistance
- Reset resistance
- Design in accordance with VDE 0660 Part 302
- This function can be activated by the machine builder by software
- Do not lay connecting cable together with control cable
- Permissible in the motor cable only with double shielding
- Connect relay K1 for fire prevention in regenerative operation (see 3.3.6)

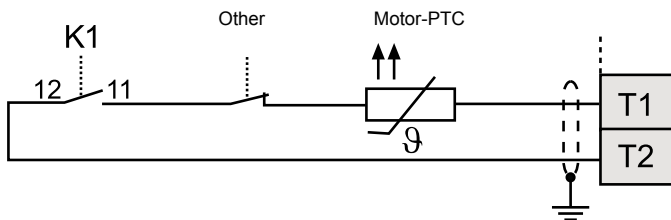

## 3.3.6 Connection of a braking resistor with fire prevention



With input rated voltage of 480 Vac no braking resistor shall be connected at control type "BASIC". The operating threshold of the braking resistor (Pn.69) must be adjusted at least to 770 Vdc for all other controls (see annex).

At defective braking transistor this circuit prevents against overheating and fire. The braking resistor overheats and opens the OH terminals with defective braking transistor. The OH terminals open the holding circuit of the input contactor, so that the input voltage is switched off in error case. An error in inverter is released by opening the auxiliary contacts 13/14 of K3 and the modulation is switched off. Regenerative operation is also secured by the internal fault disconnection. The input must be programmed and inverted to "external error". Automatic restarting after cooling of the braking resistor is prevented by the self-holding circuit of K3.



If the PTY evaluation of the motor at terminals T1/T2 is not used, these terminals can be used instead of the programmable input. The temperature input must be operated in PTC mode.

Picture 3.3.6 Braking resistor with fire prevention

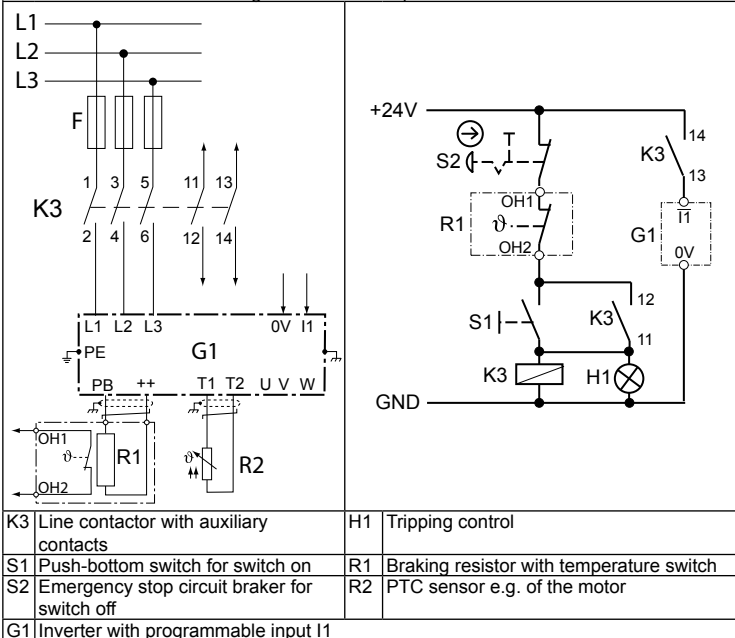

# Installation and Connection

## 3.4 Control Board Basic

### 3.4.1 X2A Control terminal strip

- Tightening torque 0.22...0.25 Nm (2 lb inches)
- Use shielded/drilled cables
- Lay shield on one side of the inverter onto earth potential

X2A

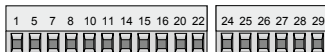

PIN	Function	Name	Explanation
1	+ Setpoint input	AN1+	Difference voltage 0...±10 VDC; Ri = 30 kΩ
Programmable analog output			0...±10 VDC (max. 5 mA)
5	Analog output	AO1	Output of the actual output frequency 0...±100 Hz => 0...±10 VDC (max. 5 mA)
7	+10V output	CRF	Reference voltage for setpoint poti +10 VDC / max. 4 mA
8	Analog Mass	COM	Mass for analog in- and outputs
Programmable digital inputs			13...30 VDC ±0% smoothed Ri: 2.1 kΩ; scan time: 2 ms
10	Fixed frequency 1 (CP.19)	I1	I1 + I2 = fixed frequency 3 (CP.21)
11	Fixed frequency 2 (CP.20)	I2	
14	Forward	F	Rotation selection
15	Reverse	R	Forward has priority
16	Control release / Reset	ST	Power modules are enabled; error reset at opening
20	24 V - output	Uout	Supply of the digital inputs (24 VDC/ max. 100 mA)
22	Digital Mass	0V	Reference potential for digital inputs/outputs
Relay outputs			Load capacity max. 30 VDC / 0.01...1 A
24	Relay 1 / NO contact	RLA	Programmable relay output (CP.31) Factory setting: Fault relay
25	Relay1 / NC contact	RLB	
26	Relay1 / switching contact	RLC	
27	Relay 2 / NO contact	FLA	Programmable relay output (CP.32) Factory setting: Frequency dependent switch
28	Relay 2 / NC contact	FLB	
29	Relay 2 / switching contact	FLC	

## 3.4.2 Connection of the control terminal strip

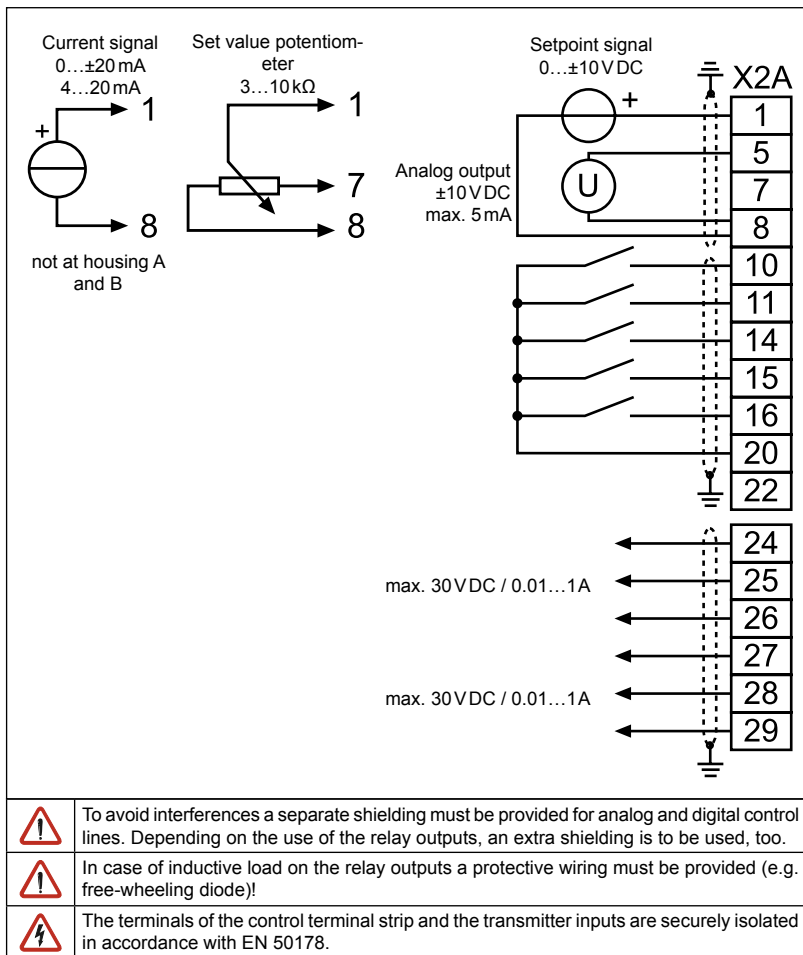

## 3.5 Control board Compact/General/Application without encoder interface

### 3.5.1 X2A Control terminal strip

<ul style="list-style-type: none"> <li>• Tightening torque 0.22...0.25 Nm (2 lb inches)</li> <li>• Use shielded/drilled cables</li> <li>• Lay shield on one side of the inverter onto earth potential</li> </ul>	<p style="text-align: center;">X2A</p> 
--	--

PIN	Function	Name	Explanation
Differential voltage input			0...±10VDC; Ri = 55kΩ
1	+ Setpoint input 1	AN1+	Setting of the analog setpoint
2	- Setpoint input 1	AN1-	
3	+Analog input 2	AN2+	
4	-Analog input 2	AN2-	
Programmable analog outputs			0...±10VDC (max. 5mA)
5	Analog output 1	AO1	Output frequency 0...±100Hz
6	Analog output 2	AO2	Apparent current 0...2·IN
7	+10V output	CRF	Reference voltage for setpoint poti +10VDC / max. 4mA
8	Analog Mass	COM	Mass for analog in- and outputs
9			
Programmable digital inputs			13...30VDC ±0% smoothed Ri: 2.1kΩ; scan time: 2ms
10	Fixed frequency 1 (CP.19)	I1	Selection of fixed frequency I1 + I2 = fixed frequency 3 (CP.21)
11	Fixed frequency 2 (CP.20)	I2	
12	External fault	I3	Input for external error setting (E.EF)
13	DC braking	I4	Activates DC braking (CP.22/23)
14	Forward	F	Rotation selection
15	Reverse	R	Forward has priority
16	Control release / Reset	ST	Power modules are enabled; error reset at opening
17	reset	RST	Reset; only possible in case of error
Digital outputs			I = max. 50mA
18	Transistor output 1	O1	Switched at real value = setpoint value
19	Transistor output 2	O2	Ready signal - switches as long as there is no error
20	24V - output	Uout	Supply of the digital inputs (24VDC/ max. 100mA)
21	20...30V - input	Uin	Voltage input for external supply
22	Digital Mass	0V	Reference potential for digital inputs/outputs
23			
Relay outputs			Load capacity max. 30VDC / 0.01...1A
24	Relay 1 / NO contact	RLA	Programmable relay output (CP.31) Factory setting: Fault relay
25	Relay1 / NC contact	RLB	
26	Relay1 / switching contact	RLC	
27	Relay 2 / NO contact	FLA	Programmable relay output (CP.32) Factory setting: Frequency dependent switch
28	Relay 2 / NC contact	FLB	
29	Relay 2 / switching contact	FLC	



## 3.5.2 Connection of the control terminal strip

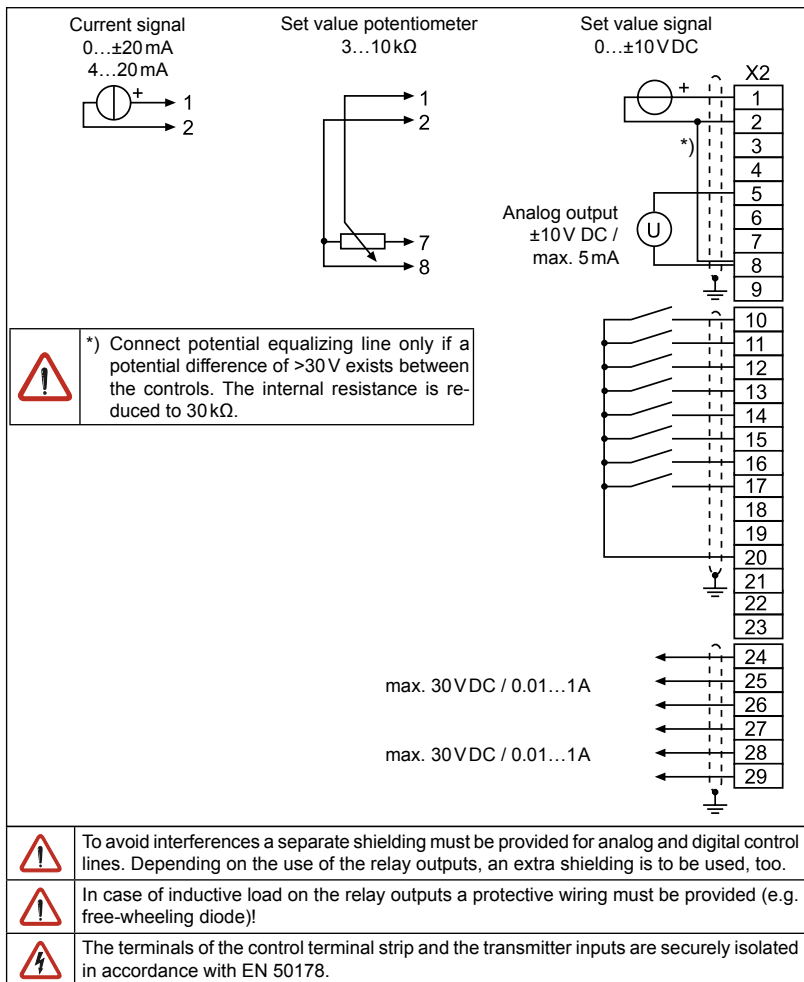

# Operation of the Unit

## 4. Operation of the Unit

### 4.1 Operation Accessories

#### 4.1.1 With HSP5 cable and without operator

A special cable (part number .00F50C0-.0001) is necessary for the control of the KEB COMBIVERT without operator. It is connected between the HSP5-interface X4A and a serial RS232-PC-interface (COM1 or COM2). The operation takes place via the PC-program COMBIVIS.



The HSP5-cable has an integrated level converter. The connection of a serial standard cable would destroy the PC-interface.

#### 4.1.2 Digital operator (part number 00F5060-1100)

As an accessory for the local operation of the KEB COMBIVERT F5 an operator is available. To prevent malfunctions, the inverter must be brought into nOP status before connecting / disconnecting the operator (open control release). When starting the inverter, it is always started with the last stored values or the factory setting.

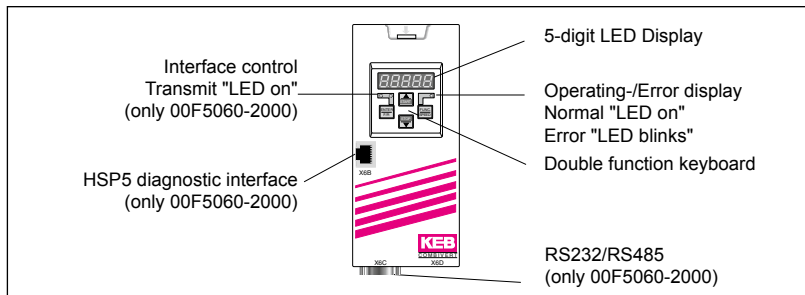

#### 4.1.3 Interface operator (part number 00F5060-2000)

The interface operator corresponds to the functional range of the digital operator. However, it is enhanced by a serial RS232/485-interface.

	PIN	RS485	Signal	Meaning
	1	-	-	reserved
	2	-	TxD	transmission signal RS232
	3	-	RxD	receive signal RS232
	4	A'	RxD-A	receive signal A RS485
	5	B'	RxD-B	receive signal B RS485
	6	-	VP	Voltage supply +5V (I <sub>max</sub> =50 mA)
	7	C/C'	DGND	Data reference potential
	8	A	TxD-A	transmission signal A RS485
	9	B	TxD-B	transmission signal B RS485

A RS232-cable is needed to connect the interface operator with the PC. The assignment is represented on the following page.

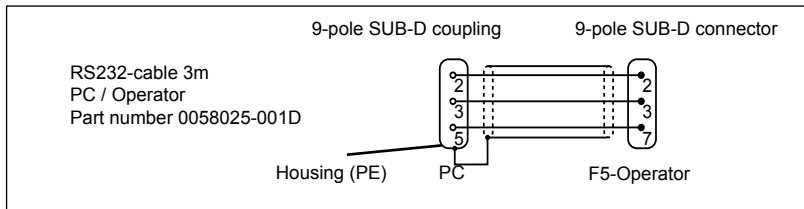

#### 4.1.4 Remote control

For remote control of the KEB COMBIVERT F5 a special HSP5 operator is available.

Operator	Cable	The last three digits of the part number indicate the length of the cable in dm.
00F5060-9000	00F50C0-2xxx	
00F5060-9001	00F50C0-3xxx	

#### 4.1.5 Other operators

In addition to the described operators the KEB COMBIVERT can be equipped with further operators for special applications (Profibus, Interbus, Sercos, CAN, DeviceNet). You find further information on that on our home page.

## 4.2 Keyboard Operation

### 4.2.1 Parameter numbers and values

When switching on KEB COMBIVERT F5 the value of parameter CP.1 appears.

The function key changes between the parameter value and parameter number.



With UP (▲) and DOWN (▼) the value of the parameter number is increased/decreased with changeable parameters.



Principally during a change, parameter values are immediately accepted and stored non-volatile. However, with some parameters it is not useful that the adjusted value is accepted immediately. In these cases the adjusted value is accepted and stored non-volatile by pressing ENTER. When this type of parameter is changed a point appears behind the last digit.

By pressing „ENTER“ the adjusted value is accepted and non-volatile stored.



## Operation of the Unit

### 4.2.2 Resetting error messages

If a malfunction occurs during operation, then the actual display is overwritten by the alarm message. The alarm message in the display is reset by ENTER.



With ENTER only the error message in the display is reset. In order to reset the error itself, the cause must be removed or a power-on reset must be made.

### 4.2.3 password input

The KEB COMBIVERT is outfitted with a comprehensive password protection. In dependence on the entered password the following modes are possible:

Display	Mode
CP_ro	End customer menu (CP-Parameter) read-only
CP_on	End customer menu (CP-Parameter) read/write
CP_SE	Service menu (like end customer menu, but with the original parameters )
APPL	Application menu (all parameter groups and parameters are visible)
-	Drive mode (COMBIVERT can be put into operation by the keyboard )

The menu admissible for the application is defined by the machine builder. The password input is generally made over the parameter CP.0. The adjusted password/menu is maintained even after switching off.

*Example: Changing the CP-parameter from read-only to read/write*

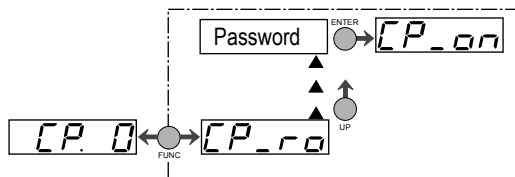

## 5. Parameter Descriptions

### 5.1 Basic/Compact/General/Application without encoder interface

Parameter	Setting range	Resolution	Default	Unit	┘	Based on
CP.0	password input	0...9999	1	-	-	ud.1
CP.1	Actual frequency display	-400...400	0,0125	0	Hz	ru.3
CP.2	Set frequency display	-400...400	0,0125	0	Hz	ru.1
CP.3	Inverter status	0...255	1	0	-	ru.0
CP.4	apparent current	0...6553,5	0,1	0	A	ru.15
CP.5	peak apparent current	0...6553,5	0,1	0	A	ru.16
CP.6	Utilization	0...65535	1	0	%	ru.13
CP.7	actual DC voltage	0...1000	1	0	V	ru.18
CP.8	DC link voltage / peak value	0...1000	1	0	V	ru.19
CP.9	Output voltage	0...778	1	0	V	ru.20
CP.10	Minimal frequency	0...400	0,0125	0	Hz	op.6
CP.11	Maximum frequency	0...400	0,0125	70	Hz	op.10
CP.12	acc. time for.	0,00...300,00	0,01	5	s	op.28
CP.13	Deceleration time (-1=CP.12)	-0,01...300,00	0,01	5	s	op.30
CP.14	S-curve time	0,00...5,00	0,01	0	s	op.32
CP.15	Boost	0,0...25,5	0,1	LTK	%	uf.1
CP.16	rated frequency	0...400	0,0125	50	Hz	uf.0
CP.17	Voltage stabilization	0...650 V (off)	1	0	V	E uf.9
CP.18	switching frequency	0...LTK	1	LTK	-	E uf.11
CP.19	Fixed frequency 1	-400...400	0,0125	5	Hz	op.21
CP.20	Fixed frequency 2	-400...400	0,0125	50	Hz	op.22
CP.21	Fixed frequency 3	-400...400	0,0125	70	Hz	op.23
CP.22	DC braking / mode	0...9	1	7	-	E pn.28
CP.23	DC braking time	0,00...100,00	0,01	10	s	pn.30
CP.24	Max. ramp current	0...200	1	140	%	pn.24
CP.25	Max. constant current	0...200	1	200:off	%	pn.20
CP.26	Speed search / condition	0...15	1	8	-	E pn.26
CP.27	Quick stopping / ramp time	0,00...300,00	0,01	2	s	pn.60
CP.28	Response of ext. overtemperature.	0...7	1	7	-	pn.12
CP.29	Analog output 1 / function	0...20	1	2	-	E an.31
CP.30	Analog output 1 / amplification	-20,00...20,00	0,01	1	-	an.33
CP.31	relay output 1 / function	0...76	1	4	-	E do.2
CP.32	relay output 2 / function	0...76	1	27	-	E do.3
CP.33	Relay output 2 / function	±30000,00	0,01	4	-	le.3
CP.34	Source of rotation direction	0...9	1	2	-	E op.1
CP.35	AN1 set value selection	0...2	1	0	-	E an.0
CP.36	AN1 zero point hysteresis	-10,0...10,0	0,1	0,2	%	an.4

LTK=depending on power unit; E=ENTER parameter

## CP-Parameters

### CP.3 inverter state

In parameter „inverter status“ the actual operating condition of the frequency inverter is displayed. In the case of an error the current error message is displayed, even if the display has already been reset with ENTER (error-LED on the operator is still blinking).

nOP	„no Operation“; control release not bridged; modulation switched off; output voltage = 0V; drive is not controlled
LS	„Low Speed“; no direction of rotation preset; modulation switched off; output voltage = 0V; drive is not controlled
FAcc	„Forward Acceleration“; drive accelerates with direction of rotation forward
FdEc	„Forward Deceleration“; drive decelerates with direction of rotation forward
rAcc	„Reverse Acceleration“; drive accelerates with direction of rotation reverse
rdEc	„Reverse Deceleration“; drive decelerates with direction of rotation reverse
Fcon	„Forward Constant“; drive runs with constant speed and direction of rotation forward
rcon	„Reverse Constant“; drive runs with constant speed and direction of rotation reverse

Status messages and information about the cause and removal are to be found at the „Standard- and Interface Operator“ instruction manual.

### CP.17 Voltage stabilization

With this parameter a regulated output voltage in relation to the rated frequency can be adjusted. For that reason voltage variations at the input as well as in the intermediate circuit only have a small influence on the output voltage (U/f-characteristic). The function allows, among other things, an adaption of the output voltage to special motors.

### CP.22 DC braking / mode

With DC-braking the motor is not decelerated by the ramp. Quick braking is caused by D.C. voltage, which is applied onto the motor winding. This parameter determines how the dc-braking is triggered.

Value	Activation
0	DC-braking deactivated
1	DC-braking at switch off of the direction of rotation and upon reaching 0Hz. The braking time is CP.23 or until the next direction of rotation.
2*	DC-braking as soon as setting for the direction of rotation is absent.
3*	DC-braking as soon as the direction of rotation changes or is absent.
4*	DC-braking at switch off of the direction of rotation and upon reaching 4 Hz.
5*	DC-braking when the real frequency falls below 4 Hz and the drives decelerates
6*	DC-braking as soon as the set value falls below 4 Hz.
7*	DC-braking when input I4 is switched (control board B = „0“)
8	DC-braking as long as input I4 is switched (control board B = „0“)
9	DC-braking after switching on the modulation.

\* Braking time depends on the actual frequency.

### CP.24 Max. ramp current

This function protects the frequency inverter against switching off through overcurrent during the acceleration ramp. When the ramp reaches the adjusted value, it is stopped so long until the current decreases again. CP.3 displays "LAS" at active function.

### CP.25 Max. constant current

This function protects the frequency inverter against switch off through overcurrent during constant output frequency. When exceeding the adjusted value, the output frequency is reduced until the value drops below the adjusted value. CP. 3 displays "SSL" at active function.

### CP.26 Speed search / condition

When connecting the frequency inverter onto a decelerating motor, an error can be triggered by the differing rotating field frequencies. With activated speed search the inverter searches for the actual motor speed, adapts its output frequency and accelerates with the adjusted ramp to the given set value. During speed search CP.3 displays "SSF". The parameter determines, under what conditions the functions operate.

In case of several conditions the sum of the value must be entered. Example: CP.26 = 12 means after reset **and** after auto-reset UP.

Value	Condition
0	Function off
1	at control release
2	at switch on
4	after reset
8	after Auto-Reset UP

### CP.28 Response of external overtemperature

CP.28 determines the response of the drive on the external temperature monitoring. At factory setting the function is switched off. In order to activate this function the power circuit terminals T1/T2 must be connected. After that the response can be adjusted according to following table. If overheat no longer exists, the message E.ndOH (or A.ndOH) is output. Only then the error can be reset or the automatic restart can be carried out.

CP.28	Display	Reaction	Restart
0	E.dOH	Immediate disabling of modulation	Remove fault; reset
1*	A.dOH	Quick stop / disabling the modul. after reaching speed 0	
2*	A.dOH	Quick stopping / holding torque at speed 0	
3	A.dOH	Immediate disabling of modulation	Autoreset, if no fault is present
4*	A.dOH	Quick stop / disabling the modul. after reaching speed 0	
5*	A.dOH	Quick stopping / holding torque at speed 0	
6*	none	No effect to the drive; With CP.31/32 an external module can be controlled (e. g. fan)	inapplicable
7	none	No effect to the drive; <b>Malfunction is not present!</b> External temperature monitoring is not activated.	

\*) If the motor is still too hot after 10 seconds, the error E.dOH is triggered and the modulation is switched off!

### CP.29 Analog output 1 / function

CP.29 defines the function of analog output 1.

Value	Function	Scaling factor
0	Absolute actual frequency CP.3	0...100% (0...±100%) 0...100Hz

## CP-Parameters

1	absolute set frequency CP.2	0...100Hz
2	actual frequency CP.3	0...±100Hz
3	Setpoint frequency CP. 2	0...±100Hz
4	output voltage CP.9	0...500V
5	DC link voltage CP.7	0...1000V
6	apparent current CP.4	0...2 • rated current
7	active current ru.17	0...2 • ±rated current
8...10	only application mode	
11	absolute active current ru.17	0...2 • rated current
12	power stage temperature ru.38	0...100 °C
13	motor temperature ru.46	0...100 °C
14...18	only application mode	
19	ramp output frequency ru.2	0...±100Hz
20	absolute ramp output frequency ru.2	0...100Hz

### CP.31 Relay output 1 / function (terminals X2A.24...26)

### CP.32 Relay output 2 / function (terminals X2A.27...29)

The switching level of CP.31 is pre-set to 100.00.

The switching level of CP.32 is adjusted by CP.33!

Value	Function
0	No function (generally off)
1	Generally on
2	run; also at DC-braking
3	ready (no error)
4	Fault relay
5	Fault relay (without auto-reset)
6	Warning or error message at abnormal stopping
7	OL warning
8	OH warning
9	External Overtemperature alert signal motor
11	Overtemperature alert signal interior OHI
12	Cable breakage 4...20 mA on analog input 1
14	max. constant current (Stall, CP.25) exceeded
15	max. ramp current (LA-Stop, CP.24) exceeded
16	DC-braking active
20	Actual value = set value (CP.3 = Fcon; rcon; not at noP, LS, error, SSF)
21	acceleration (CP.3 = FAcc, rAcc, LAS)
22	deceleration (CP.3 = FdEc, rdEc, LdS)
23	act. rotation = set rotation
24	Utilization (CP.6) > switching level
25	Active current > switching level
26	Intermediate circuit voltage (CP.7) > switching level
27	Real value (CP.1) > switching level
28	Set value (CP.2) > switching level
31	Absolute set value at AN1 > switching level
32	Absolute set value at AN2 > switching level
34	Set value at AN1 > switching level



35	Set value at AN2 > switching level
40	hardw.curr. limit active
41	modulation on
44	Inverter status > switching level
45	Power stage temperature > switching level
46	Motor temperature > switching level
47	Ramp output value > switching level
48	Apparent current (CP.4) > switching level
49	rot. forward (not at nOP, LS, abnormal stopping or error)
50	rot. reverse (not at nOP, LS, abnormal stopping or error)
63	Absolut ANOUT1 > switching level
64	Absolut ANOUT2 > switching level
65	ANOUT1 > switching level
66	ANOUT2 > switching level
70	Driving current active (safety relay)
73	Absolute active power > switching level
74	Active power > switching level

No listed values are only for application mode.

## CP-Parameters

---

### CP.34 Source of rotation direction

The source rotation setting and the mode of evaluating the rotation setting is defined with this parameter (Enter-Parameter). With CP.34 one does not modify the rotation source of the fixed frequencies (CP.19...21).

Value	Direction of rotation
0/1	only application mode
2	Setting by way of terminal strip forward/reverse; negative set values are set to zero (factory setting)
3	Setting by way of terminal strip forward/reverse; the sign of the set point values have no effect on direction of rotation
4	Setting by way of terminal strip run/stop (X2A.14) and forward/reverse (X2A.15); negative values are set to zero
5	Setting by way of terminal strip run/stop (X2A.14) and forward/reverse (X2A.15); the sign of the set point values have no effect on direction of rotation
6	Set value dependent, positive value = clockwise rotation; negative value=counter-clockwise rotation; Status "Low speed" (LS) if no terminal For or Rev is active
7	Set value dependent, positive value = clockwise rotation; negative value = counter clockwise rotation clockwise rotation is indicated if set value is "0"
8/9	only application mode

### CP.35 AN1 set value selection

The setpoint input 1 (AN1) at the F5-GENERAL/COMPACT control can be driven by various signal levels. In order to correctly evaluate the signal, this parameter must be adapted to the signal source. At F5 Basic control board at housing type A or B the signal source may not be re-adjusted.

Value	Set value signal
0	0...±10VDC / GENERAL/COMPACT Ri = 55 kΩ / BASIC Ri = 30 kΩ
1	0...±20mADC / Ri = 250 Ω
2	4...20mADC / Ri = 250 Ω

## A. Annex A

### A.1 Overload characteristic

Release time [s]

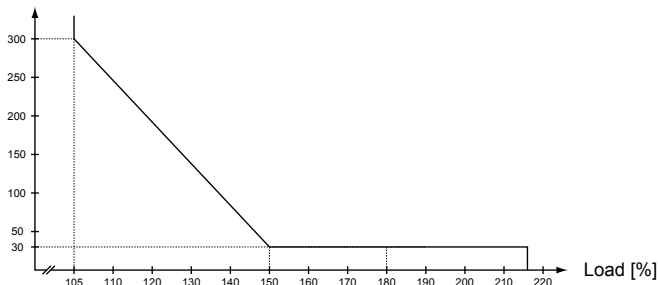

On exceeding a load of 105% the overload integrator starts. When falling below the integrator counts backwards. Error E.OL is triggered if the integrator achieves the overload characteristic.

### A.2 Calculation of the motor voltage

The motor voltage for dimensioning of the drive is depending on the used components. The mains voltage reduces according to the following table:

Mains choke Uk	4%	Example:
Inverter open loop	4%	Closed loop inverter with mains- and motor choke at
Inverter closed loop	8%	non-rigid supply system:
Motor choke Uk	1%	400 V mains voltage - 15% = 340 V motor voltage
Non-rigid supply system	2%	

### A.3 Maintenance

All work may only be done by qualified personnel. The security must be ensured as follows:

- Disconnect power supply at MCCB
- Secure against restarting
- Await discharge time of capacitors (if necessary controlling by measurement at „+PA“ and „-“, respectively „++“ and „--“)
- Ensure loss of voltage by measurement

In order to avoid premature ageing and avoidable malfunctions, the measures mentioned below must be carried out in the appropriate cycle.

Cycle	Function
Constant	Pay attention to unusual noises of the motor (e.g. vibrations) as well as of the frequency inverter (e.g. fan).
	Pay attention to unusual smells of the motor or frequency inverter (e.g. evaporation of capacitor electrolyte, braise of the motor winding)
Monthly	Check unit for loose screws and plugs and if necessary tighten up.
	Clean frequency inverter from dirt and dust deposits. Pay attention especially to cooling fins and protective grid of the fans.
	Examine and clean extracted air filter and cooling air filter of the control cabinet.
	Examine function of the fans of the KEB COMBIVERT. The fans must be replaced in case of audible vibrations or squeak.

## A.4 Storage

The DC link of the KEB COMBIVERT is equipped with electrolytic capacitors. If electrolytic capacitors are stored de-energized, the oxide film working as dielectric fluid reacts with the acidic electrolyte and destroy themselves slowly. This affects the dielectric strength and the capacity.

If the capacitor starts running with rated voltage, it is tried to build the oxide film abrupt again. This causes heat and gas and leads to the destruction of the capacitor.

In order to avoid defectives, the KEB COMBIVERT must be started up depending on the storage period in accordance with the following specification:

Storage period < 1 year			
•	Start-up without special measures		
Storage period 1...2 years			
•	Operate frequency inverter one hour without modulation		
Storage period 2...3 years			
•	Remove all cables from the power circuit; especially of braking resistor or module		
•	Open control release		
•	Connect variable transformer to inverter input		
•	Increase variable transformer slowly to indicated input voltage (>1 min) and remain at least on the specified time.		
	Voltage class	Input voltage	Residence time
	230V	0...160V	15 min
		160...220V	15 min
		220...260V	1 h
	400V	0...280V	15 min
		280...400V	15 min
		400...540V	1 h
			further on next side

Storage period > 3 years

- Input voltages as before, however double the times per year. Eventually change capacitors. Eventually change capacitors.

After expiration of this start-up the KEB COMBIVERT can be operated on nominal rating conditions or delivered to a new storage.

## A.5 Changing the response threshold of the braking transistor

(not valid for control type „BASIC“)

To prevent a premature switching of the brake transistor at input rated voltage of 480 Vac, the response threshold must be adjusted according to the following diagram.

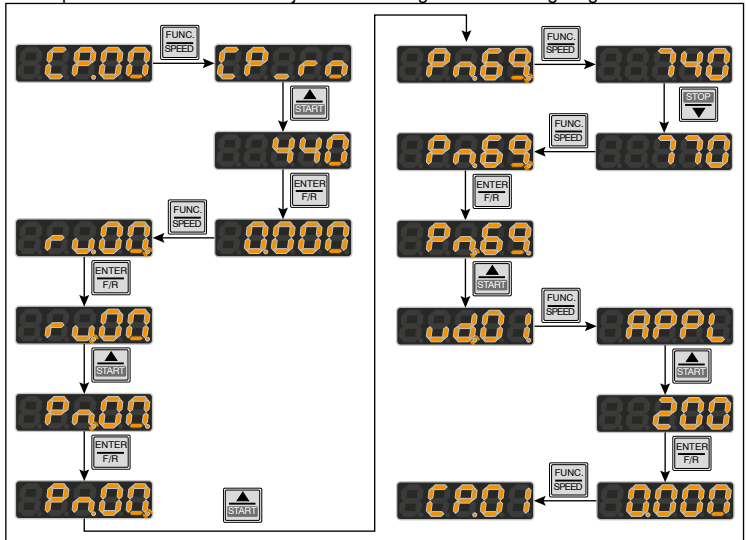

### B. Annex B

#### B.1 CE-Marking

CE marked frequency inverter and servo drives were developed and manufactured to comply with the regulations of the Low-Voltage Directive 2006/95/EC.

The inverter or servo drive must not be started until it is determined that the installation complies with the Machine directive (2006/42/EC) as well as the EMC-directive (2004/108/EC)(note EN 60204).

The frequency inverters and servo drives meet the requirements of the Low-Voltage Directive 2006/95/EC. The harmonized standards of the series EN61800-2 were used.

This is a product of limited availability in accordance with IEC61800-3. This product may cause radio interference in residential areas. In this case the operator may need to take corresponding measures.

#### B.2 UL Marking

	Acceptance according to UL is marked at KEB inverters with the adjacent logo on the type plate.
---	---

**To be conform according to UL for use on the North American Market the following instructions must be observed (original text of the UL-File):**

- Suitable For Use On A Circuit Capable Of Delivering Not More Than 10000 rms Symmetrical Amperes, 240 or 480 Volts Maximum" when "Protected by Fuses" see Instruction Manual for specific fuse details and Alternate Branch Circuit Protection details".
- Maximum Surrounding Air Temperature 45°C (113°F)
- For control cabinet mounting as „Open Type“
- Use in a pollution degree 2 environment
- Use 60/75°C Copper Conductors Only
- Motor protection by adjustment of current parameters.For adjustment see application manual parameters Pn.14 and Pn.15.
- Motor Overtemperature Protection:  
These drive models are not provided with load and speed sensitive overload protection and thermal memory retention up on shutdown or loss of power (for details see NEC, article 430.126(A)(2)".
- Only for use in WYE 480V/277V supply sources
- Overload protection at 130 % of inverter output rated current (see type plate)
- Operator and Control Board Rating of relays (30Vdc.:1A)
- Integral solid state short circuit protection does not provide branch circuit protection. Branch circuit protection must be provided in accordance with the Manufacturer Instructions, National Electrical Code and any additional local codes, or the equivalent. Branch Circuit Protection for inverters F5–B housing:

Inverter	Input Voltage	UL248 Fuse Class CC, J or RK5 #1)
----------	---------------	-----------------------------------

	[V]	[A]
05F5	240 /1ph	10
	240 /3ph	6
05F5	480 / 3ph	5
07F5	240 /1ph	15
	240 /3ph	10
07F5	480 / 3ph	6
09F5	240 /1ph	20
	240 /3ph	15
09F5	480 / 3ph	10
10F5	240 /1ph	30
	240 /3ph	25
10F5	480 / 3ph	12
12F5	480 / 3ph	15

#1) The voltage rating of the Class rated fuses shall be at least equal to the voltage rating of the Drives.

Branch Circuit Protection: Type E Self Protected Manual Motor Controllers for inverters F5–B housing. Type and manufacturer and electrical ratings as specified below:

Cat. No.	Drive Input rating	Self Protected Manual Motor Controller Type and manufacturer	Self Protected Manual Motor Controller rating
05F5	240V/ 1ph	PKZMO-10E, Eaton Industries	230V/1ph, 1.5 hp
05F5	240V/ 3ph	PKZMO-6.3E, Eaton Industries	230V/ 3ph, 1.5 hp
07F5	240V/ 1ph	PKZMO–16E, Eaton Industries	230V/ 1ph, 2 hp
07F5	240V/ 3ph	PKZMO-10E, Eaton Industries	240V/ 3ph, 3 hp
09F5	240V/ 1ph	PKZMO-20E, Eaton Industries	230V/ 1ph, 3 hp
09F5	240V/ 3ph	PKZMO–16E, Eaton Industries	230V/ 3ph, 5 hp
10F5	240V/ 1ph	PKZMO-32E, Eaton Industries	230V/ 1ph, 5 hp
10F5	240V/ 3ph	PKZMO–16E, Eaton Industries	230V/ 3ph, 5 hp

Cat. No.	Drive Input rating #	Self Protected Manual Motor Controller Type and manufacturer	Self Protected Manual Motor Controller rating
05F5	480V/ 3ph	PKZMO-10E, Eaton Industries	480Y/277V, 7.5 hp

07F5	480V/ 3ph	PKZMO-10E, Eaton Industries	480Y/277V, 7.5 hp
09F5	480V/ 3ph	PKZMO-10E, Eaton Industries	480Y/277V, 7.5 hp
10F5	480V/ 3ph	PKZMO-12E, Eaton Industries	480Y/277V, 7.5 hp
12F5	480V/ 3ph	480V/ 3ph PKZMO-12E, Eaton Industries	480Y/277V, 10 hp

# all Drives series which use a Self Protected Motor Controller rated 480Y/277V are suitable for 480Y/277V sources only.

### B.3 Additional Manuals

You find supplementary manuals and instructions for the download under

[www.keb.de](http://www.keb.de) > Service > Downloads

General instructions

- Part 1 EMC-and safety instructions

Unit-specific instructions

- Part 2 Power Circuit
- Part 3 Control Circuit

Service notes

- Up- /Download of parameter lists with KEB COMBIVERT
- Error messages

Instruction and information for construction and development

- Application Manual
- Preparation of a user-defined parameter menu
- Programming of the digital inputs
- UL input fusing for COMBIVERT F5

Approvals and approbations

- Declaration of conformity CE
- UL-Yellow Card (<http://www.ul.com>)



