



**EISENBLÄTTER**

Simply better ideas.

**2016**

EN





EISENBLÄTTER



EISENBLÄTTER



EISENBLÄTTER



EISENBLÄTTER



EISENBLÄTTER



EISENBLÄTTER



EISENBLÄTTER



EISENBLÄTTER



EISENBLÄTTER



EISENBLÄTTER



EISENBLÄTTER



EISENBLÄTTER



EISENBLÄTTER



EISENBLÄTTER



EISENBLÄTTER



EISENBLÄTTER



EISENBLÄTTER



EISENBLÄTTER



**Eisenblätter heroes in**





**EISENBLÄTTER**

Simply better ideas.



**action all over the world**



### EISENBLÄTTER

- Contact Us . . . . . 10
- New Factory . . . . . 12
- New Products . . . . . 14
- Key for Icons . . . . . 21
- Article Number Index . . . 222

# 8



### ANGLE-GRINDING – CIRCULAR GRINDING

- Cutting & Rough Grinding . . . 24
- Grinding & Blending . . . . . 27
- Finishing & Fine Grinding . 54
- Polishing . . . . . 62
- Cleaning . . . . . 66
- Power Tools . . . . . 68

# 22

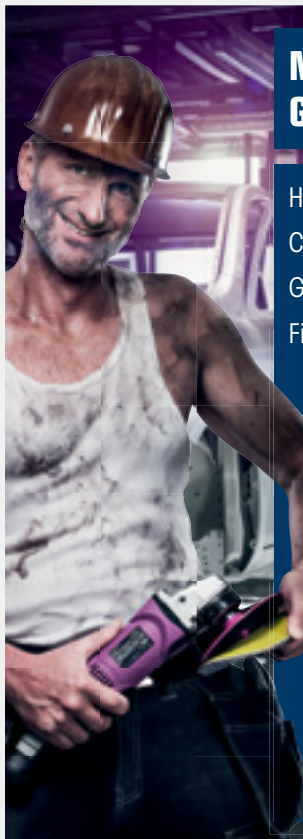

### MULTIFUNCTIONAL GRINDING

- Hook & Loop  
Complete System . . . . . 86
- Grinding & Blending . . . . . 99
- Finishing & Fine Grinding . . 101
- Polishing . . . . . 102
- Cleaning . . . . . 103
- Technical Brushes . 104
- Power Tools . . . . . 106
- Stationary  
Machines . . . . . 110

# 84



### LINEAR GRINDING – SATIN FINISHING

- Grinding & Blending . . . . . 116
- Finishing & Fine  
Grinding . . . . . 122
- Polishing . . . . . 128
- Cleaning . . . . . 135
- Technical Wheels . . 137
- Power Tools . . . . . 140

# 114



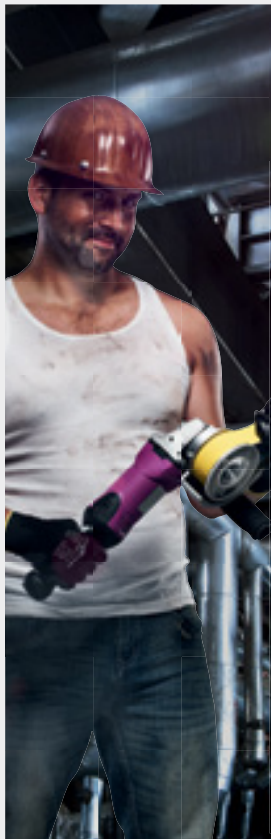

**BELT GRINDING**

Grinding & Blending . . . . . 155  
Finishing & Fine Grinding . . 158  
Polishing . . . . . 163  
Power Tools . . . . . 170

**152**



**DEBURRING AND BEVELLING**

Power Tools . . . . . 192  
ROLEI Deburring System . . . 195  
Stationary Machines . . . . 196

**190**



**CHEMICALS AND CARE PRODUCTS**

Cleaning . . . . . 210  
Protection . . . . . 211  
Preserve . . . . . 212  
Grinding Additives . . 213

**208**



**ACCESSORIES**

**214**





**1800 watts –  
130 cuts!\***

\*Achieved with the VARILEX® WSF 1800 Professional and RAZORCUT® cutting disc 1 mm.

# EISENBLÄTTER

**CONTACT US** ..... 10

**NEW FACTORY** ..... 12

**NEW PRODUCTS** ..... 14

MAGNUM® RAZORCUT® ..... 14

COLDSTEEL® ..... 14

E-Boxx Case ..... 15

MAGNUM® Unitized ..... 15

BRIGHTEX® Polishing System ..... 16

MAGNUM® Cool Top® 8 ..... 18

Cut & Polish (S/C) Fleece Wheel ..... 18

ROLEI PEF 500 Product Improvements ..... 19

ROLEI EF 165 Product Improvements ..... 19

MINI MAX® PRO ..... 20

**KEY FOR ICONS** ..... 21



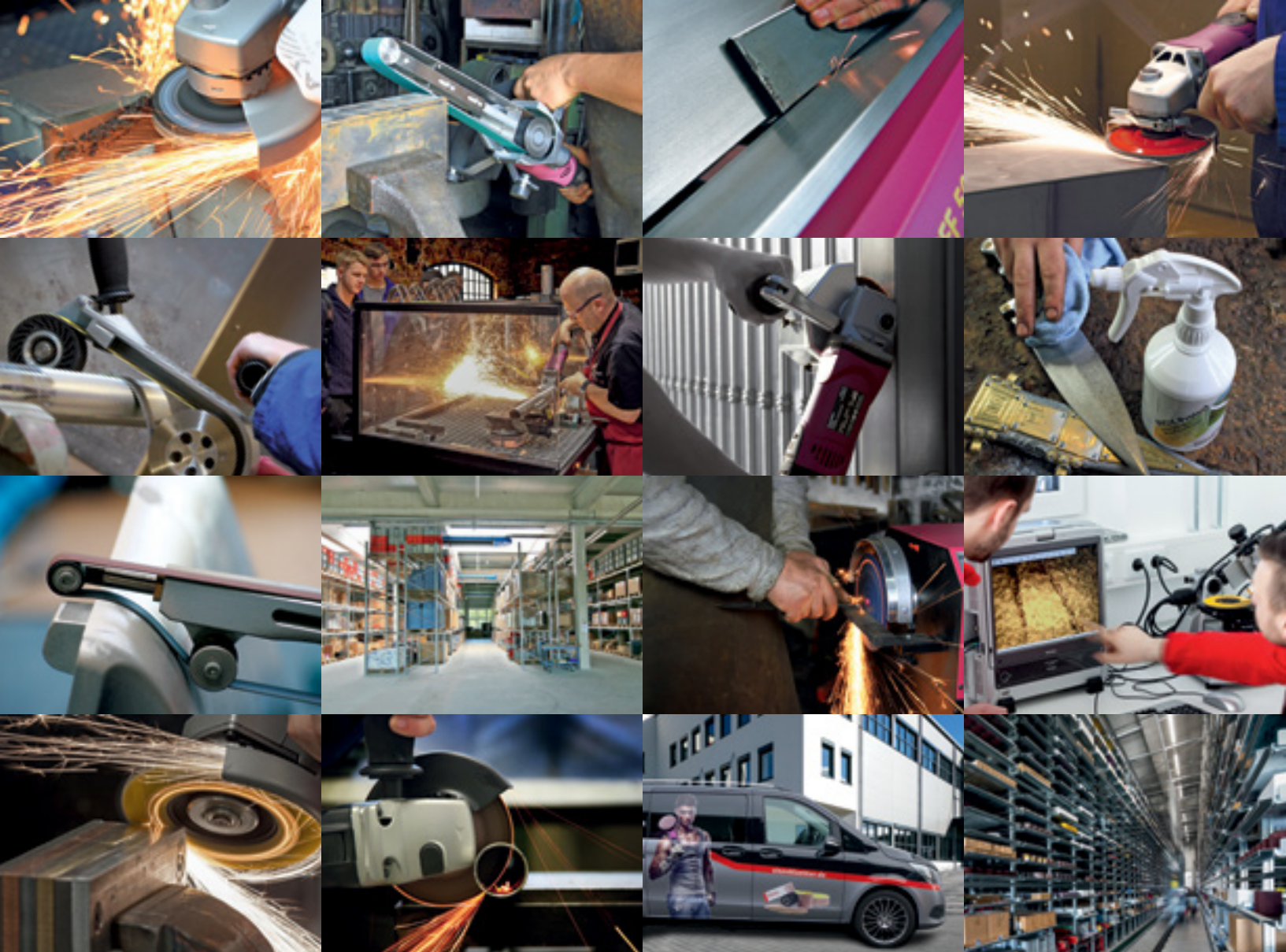

## HOW TO CONTACT US

### Our main contact phone numbers:

Main Office (+49) 8171 9082 – 010  
 Sales (+49) 8171 9082 – 020  
 Purchasing (+49) 8171 9082 – 050  
 Accounts (+49) 8171 9082 – 060

### Our main contact fax numbers:

Main Office (+49) 8171 9082 – 210  
 Sales (+49) 8171 9082 – 220  
 Purchasing (+49) 8171 9082 – 250  
 Accounts (+49) 8171 9082 – 260

### New main office address:

Jeschkenstraße 12d  
 D-82538 Geretsried

### New delivery address:

Keplerweg 4  
 D-82538 Geretsried

### Eisenblätter online:

info@eisenblaetter.de  
 eisenblaetter.de  
 eisenblaetter.tools

### Eisenblätter Demo Center

Koblenzer Str. 29a  
 D-56656 Brohl-Lützing  
 Tel. (+49) 2633 2000 982  
 Fax (+49) 2633 2000 983  
 demo@eisenblaetter.de



**Dear Customers and Business Partners,**

Before we have the pleasure of introducing you to the proven and new products in our new 2016 general catalogue, we would first like to thank you for your interest and your loyalty.

Always central to everything we do at Eisenblätter is the interaction between man and machine. That's why it's important to us that all our products don't just meet a very high standard of quality but are also some of the best there are! We are delighted to present to you today our product range, that has been refined over the years and is all encompassing, for all grinding, polishing and cutting tasks. You'll achieve top results in record time with our products.

What you demand, we deliver. This is because we are motivated by our customers' needs as to what we develop in our laboratories. To meet the challenges of the years to come, we've built a new state-of-the-art company premises in the town of Geretsried in Bavaria. With our Made in Germany strategy, we're safeguarding jobs and driving forward customer-led innovation.

Our diverse range of quality and high-tech products are legendary items, stretching across all sectors, this diverse range, for example our flap discs, have allowed us to create a new customer-friendly structure for our 2016 catalogue. The systematic layout will guide you to the information you need quickly. We would also like to invite you to find out more about Eisenblätter tools and accessories in person at our demo centre in Brohl-Lützing or at the factory in Geretsried.

So why not visit us and take the opportunity for a free introduction to our products? Or visit us at our new website.

Our mobile demo centre on the Eisenblätter demo bus can also come directly to you on request. You'll find our contact details on the page to the left.

We look forward to seeing you.

**Yours,  
Gerd Eisenblätter, CEO  
David Eisenblätter, COO**



## PRODUCTION SITE

# Cutting Edge Change!

We did not just polish the surface!

Few companies have so consistently made an impact on the grinding and polishing industry as Eisenblätter. Whether it's the architecture of the company premises or the design of the products, Eisenblätter has always gone its own way, rigorously pursued new technologies and introduced high quality standards.

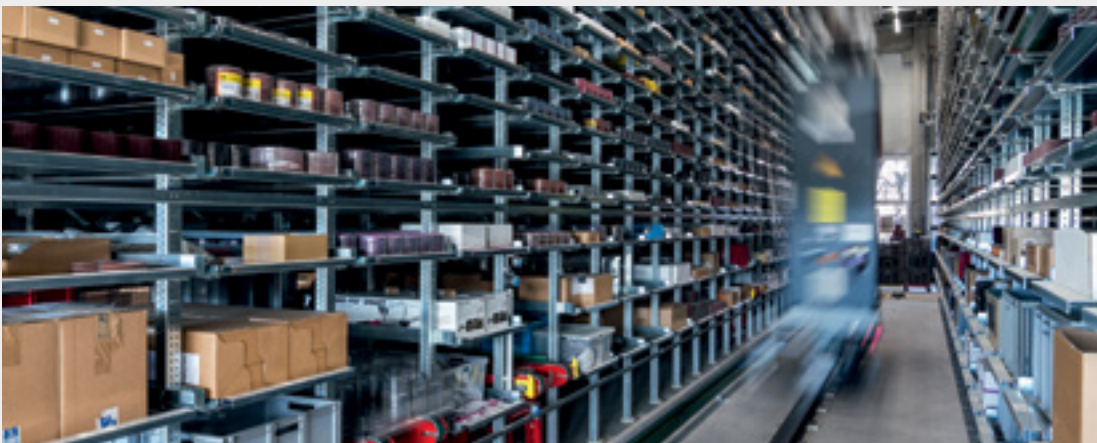

◀ Fully automatic storage and production systems





### Eisenblätter is a brand.

A brand which – like a personality – has developed over the years. It is the world of Eisenblätter surface finishes. Our "heroes" – our Eisenblätter premium products – are so popular that we have had to grow. We couldn't have continued at our old production plant. Now production, logistics, dispatch, service and the customer service centre are all united under one roof. The 7,000 or so square metres of additional factory floor and the close links it provides between departments allow us not only to consult on innovations every day but also to develop them in our own grinding laboratories. The arch in our logo forms a bridge between the three worlds of grinding, polishing and cutting that leads to new environmentally friendly technologies. The line under it represents the healthy foundation that underpins the company and what we do. The red and grey of our corporate colours provide a clear signal and reflect the power, dynamism and effectiveness of our products.

Our claim of "Simply better ideas" isn't just something we've plucked out of the air but a strength that has grown with us – as the feedback we receive from our customers tell us time and again. Eisenblätter is a company which develops and manufactures high-tech grinding and polishing systems. The fact that our products are "Made in Germany" allow us to do it with a clear conscience. We stand by that.



**ACHIEVE 130 CUTS!**

# MAGNUM<sup>®</sup> RAZORCUT<sup>®</sup>

So sharp it shouldn't be allowed!

**Eisenblätter blows records apart in metalworking.**

**1 mm cutting disc makes 130 cuts. Up to 50% improvement in performance!**



Up until now, the best performance was by the MAGNUM<sup>®</sup> FINECUT for pre-defined tube cuts. In Eisenblätter's tests it achieved approx. 80 cuts of Ø 27 mm diameter stainless steel tube with a wall thickness of 2 mm. With the new MAGNUM<sup>®</sup> RAZORCUT<sup>®</sup> cutting disc, we can achieve 130 cuts!

That's over 50 % more cuts. This new innovation by Eisenblätter is for universal use with all metals.

For our customers, a long service life and high cutting speed means a large reduction in labour and variable costs. Stock-keeping costs are also reduced. In addition, the discs are considerably easier to handle. Like a knife through butter. Why not give it a try?

**SEE PAGE 24 FOR MORE DETAILS.**

**NEWLY DEVELOPED CERAMIC FIBRE DISC**

# COLDSTEEL<sup>®</sup>

Ceramic. Cold. Aggressive.

**The new COLDSTEEL<sup>®</sup> ceramic fibre discs are a new generation of high-performance fibre discs.**



Ultra-fine grit and crystal structures provide for significantly more self-sharpening edges and a huge improvement in material removal.

Improved operational speeds are achieved through sharp grains (better grip), aggressivity and cooler grinding. Even in the coarse grit range and at a high rate of material removal, the size of the chip particles remain relatively small, which in turn can prevent damage caused by the afterglow behavior of metal particles that are too large.

The finer grinding result on the surface of the workpiece reduces the frequent need to finish the piece using finer grits.

COLDSTEEL<sup>®</sup> ceramic fibre discs are supplied in all generally available diameters and grits. Packed in a practical resealable bag.

**SEE PAGE 52 FOR MORE DETAILS.**

**EVERYTHING IN ITS PLACE!**

## E-Boxx case

Stack. Protect. Carry.



Use the new E-Boxx case to organise your Eisenblätter products! A place for everything and everything in its place. The E-Boxx case allows you to have tools with you everywhere, working on site and lots more.

The E-Boxx case is extremely heavy duty and provides not only the maximum use of the available volume while taking up minimal space but also total protection for tools, power tools and consumables when away on jobs. The integrated latch completes the sturdy design and makes the E-Boxx case stackable. The foam inserts, which can be customised to fit the respective product, ensure that tools are held securely, protected from jolts and stored tidily.

Our E-Boxx cases have a large, heavy-duty and ergonomic handle which makes carrying them around a breeze.

**SEE PAGE 217 FOR MORE DETAILS.**

**NEW GRINDING EVOLUTION**

## MAGNUM<sup>®</sup> Unitized

Multi-layered. Impregnated. Grinding additive.

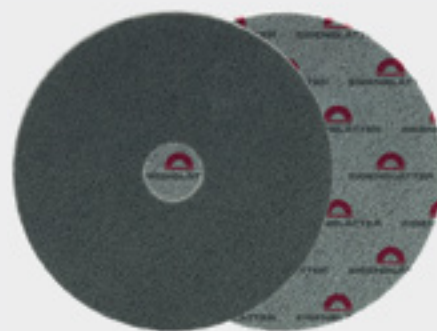

You'll be amazed when you use MAGNUM<sup>®</sup> Unitized for deburring, smoothing sheet metal, pipes, weld seams and fillet welds.

This special range was specifically developed for fine grinding, weld seams, spot welds and eliminating scratches. The high compressive force applied to multi-layered fleece followed by a foam compression impregnation process means the non-woven Unitized is a brand new product. Grinding will leave you astonished, no brush marks. This application allows the product to be immediately reworked to obtain a satin finish or to polish a workpiece to a mirror finish.

You can achieve a mirror finish with the Eisenblätter BRIGHTEX<sup>®</sup> polishing system that is to be found in this catalogue together with belts, grinding discs, sleeves and pastes. Whether you want to use it on the side or the face of the disc, everything is possible.

When using the 125 mm discs, we recommend using our height adjusting washer (#65005) onto the machine flange.

The available sizes and material thicknesses of the MAGNUM<sup>®</sup> Unitized are shown in the **CATALOGUE ON PAGE 60.**



## POLISHING BY CONCEPT

# BRIGHTEX® Polishing System

A mirror finish is a breeze with Eisenblätter.

**Are you over expensive and time-consuming polishing processes with results that are still poor?  
Now that's history. Only two steps and you'll be able to see yourself in the finish!**



The newly developed BRIGHTEX® system by Eisenblätter, the original, puts a shadow-free mirror finish on untreated metal. For the first time, this totally new form of technology and specially developed polishing fleece coated in a highly innovative universal polishing paste allow mirror polishing in one operation – and with just ONE disc. Instead of rotating the tool with pastes and creams or scratching away at the workpiece, our polishing discs are soaked through with pastes. What does that mean for you? Just fit the BRIGHTEX® polishing disc using the FIX HOOK & LOOP system to the backing pad and start polishing. It takes mirror finish polishing to a new level. Removing the hassle of having to apply pastes and creams. With the BRIGHTEX® Berry polishing disc, you'll be able to complete the pre-polish and main polish stages in one operation. For removing any paste residues, we supply our fully non-scratch powder, BRIGHTEX® Softclean powder, used in conjunction with BRIGHTEX® non-scratch cloths for removing residue.

### **Looking for the chrome-plated look? No problem.**

You can achieve an unrivaled extra shine – almost akin to chrome plating – with BRIGHTEX® Sun polishing paste and our yellow BRIGHTEX® Sun polishing products. Chrome-like mirror finish is guaranteed. If your workpiece is already scratched prior to polishing, you can pre-grind it using Trizact™ tools, for example, in A30/600 grit and then start immediately with BRIGHTEX® Berry! Whether you want to use belts, Fix discs or sleeves, all these are now available in the BRIGHTEX® polishing system. As a result, a mirror finish on tubes and pipes using pipe machining equipment, such as the PIPE MAX and PIPE SNIPER® is easier to achieve and brings better results. Likewise, for large surface areas you can fit our POLY-PTX® 800 linear grinding system or our GLADIUS® 1800 grinding sword with the respective BRIGHTEX® sleeves and belts. Eisenblätter flexibility is not only guaranteed but very easy to get hold of as well. All you need to do is ask.

**FIX / MINI FIX  
BRIGHTEX® Discs**

Polishing material that is already impregnated with BRIGHTEX® polishing paste removes the hassle and time-consuming business of applying pastes and creams to give untreated metal a shadow-free mirror finish.

**BRIGHTEX® Polishing Pastes –  
Berry and Sun**

Berry: For the first time, pre-polish and main-polish in one operation!

Sun: For a mirror finish as if chrome-plated.

**BRIGHTEX® Non-Scratch Cloth**

Much improved, ultra-soft microfibre cloth, free of seams for non-scratch cleaning of stainless steel surfaces and decorative metals.

**BRIGHTEX®  
Polishing Belt and Sleeve**

Polishing material that is already impregnated with BRIGHTEX® polishing paste removes the hassle and time-consuming business of applying pastes and creams to give untreated metal a shadow-free mirror finish.

**BRIGHTEX® Softclean Powder**

A new and much improved cleaning powder removes all cream and paste residues after every polish and allows all metals to shine completely scratch-free (replaces POLY Lime).

100 % PURE ZIRCONIUM ON A 100 % COTTON BACKING

# MAGNUM® Cool Top® 8

Legendary quality is now even better!

The **MAGNUM® Cool Top®** is now a familiar flap disc from Eisenblätter. After all, it wouldn't be like us not to keep honing our standard of quality.



Improved performance – and not only in continuous operation or in the formulation. 100 % pure zirconium on a 100 % cotton backing. All with food-grade, special plastic backing plates which can be trimmed – that's what makes the **MAGNUM®** range by Eisenblätter a legend. This versatile technology with its outstanding benefits is only available from us due to our worldwide patented manufacturing process. Under the brand name of **MAGNUM® Cool Top® 8**, this flap disc has a significantly wider range of applications on most types of steel. It delivers a 30 % improvement in performance compared to the **Cool Top® 5**. A cooler, reduced grinding temperature and the cooling agents incorporated in the binding provide for good metal grinding conditions while working.

As a result, there is no heat discoloration. The high degree of elasticity prevents vibration and noise. Both discs – **MAGNUM® Cool Top® 8** and **5** – can of course be supplied, and so we're able to cover all customer requirements to the full extent. The proven flexible backing plate (fibre glass-free!) allows smooth and "softer" blending to be achieved. This in turn drastically reduces the finishing work required. The **MAGNUM® Cool Top® 8** can be trimmed which allows virtually all of the abrasive fabric to be used and in turn results in major time and cost savings. In high-performance and continuous operation applications in shipyards and steel construction, only **MAGNUM®** quality flap discs can deliver this. There's simply no alternative.

**SEE PAGE 38 FOR MORE DETAILS.**

CREATE A SATIN FINISH FAST

# Cut & Polish (S/C) Fleece Wheel

For the first time, Eisenblätter has introduced a new type of fleece wheel which allows the recognized standard stainless steel finish to be achieved lightning fast in 240 to 280 grit with intense and bright shiny grinding results.



Due to the extremely high grit content combined with a silicon carbide grit mix, you can accomplish this recognised satin finish very quickly on a range of stainless steel. It is possible to work directly on the bare sheet metal of untreated stainless steel surfaces with no

scratches. Any oxide layers will be quickly removed by the high grit content. This produces a very attractive-looking bright-shining effect. Can also be used for other metals, such as non-ferrous metals.

**SEE PAGE 119 FOR MORE DETAILS.**

## ROLEI PRODUCT IMPROVEMENTS

# ROLEI PEF 500

For bevelling metal components and long metal rods

The PEF 500 has a new accessory available which adds an extra roller guide for clean bevelling on the outer edges of sheet metals of 2 – 5 mm at angles of 30 – 45 degrees (e.g. name badges and so on).

- Now also suitable for precision bevelling
- Additional guide rails available as an option for square rod material
- Precise fine-threaded adjustment screws for the ultimate in accuracy

**SEE PAGE 200 FOR MORE DETAILS.**



## ROLEI PRODUCT IMPROVEMENTS

# ROLEI EF 165

Technologically improved deburring and bevelling tool

From now on, all the settings on the EF 165 bench tool can be fully selected without tools and set precisely by hand using adjustable knurled screws.

- Now available as a finely adjustable version without tools
- An industrial suction flange is included in the scope of delivery.
- Quick-change support table for optional extension to 700 mm

**SEE PAGE 196 FOR MORE DETAILS.**



WHEN SPACE IS AT A PREMIUM!

# MINI MAX<sup>®</sup> PRO

Perfectly adjusts to the surface!



With the MINI MAX<sup>®</sup> PRO, Eisenblätternow has a vastly improved grinder in its range. It is ideally suited for the use of mini grinders, such as shaft tools (fleece, mix, flap wheels), or Eisenblättern's own MINI FIX Hook & Loop system or Roloc<sup>™</sup>. A considerably more compact design, the drive arm has made the machine smaller and easier to use. A newly developed clamping process for shaft tools provides an even more compact form, which greatly simplifies grinding jobs in normally inaccessible places. As a result, this also improves the grinding results for your surfaces. Benefits and more benefits.

The new clamping system allows the shaft to be completely inserted through the drive axle which significantly extends the range of applications for workpieces with tight angles or in housing recesses. A flexible shaft can also be secured by the clamping flange and thus serves as the drive source for your "finest work". MINI MAX<sup>®</sup> PRO has a high-performance 850-watt motor and, like all Eisenblättern originals, an infinitely adjustable range of speed.

**SEE PAGE 106 FOR MORE DETAILS.**





### KEY FOR ICONS



#### 5° angle of incidence

Tool support at 5° angle



#### Flexible

Flexible material



#### Flexible

Flexible backing



#### Copyrighted design

Design or product feature is subject to copyright

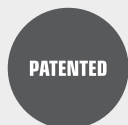

#### Patented

Patented



#### Patent pending

Patent applied for



#### Permitted use

Suitable for cutting



#### Permitted use

Not approved for side grinding



#### Permitted use

Suitable for rough and side grinding



#### Free of fibre glass

Free of fibre glass components



#### Natural fibre

Backing plate consists primarily of sustainable natural fibre



#### Plus backing pad

To be used only in conjunction with a suitable backing pad



#### Reduce noise

Reduction in noise level under load



#### Flat support area

Flat surface contact



#### Trimmable

Disc backing plate can be trimmed



#### Balanced

Unique wheel balancing to ensure wheel runs perfectly



#### Accessories

Accessory items



#### Material – all metals

To be used on all metals



#### Material – aluminium

To be used on aluminium



#### Material – non-ferrous metals

To be used on non-ferrous metals



#### Material – stainless steel

To be used on stainless steel



#### Material – wood

To be used on wood



#### Material – steel

To be used on steel



#### Material – hard plastics

To be used on hard plastics



#### MPA-tested

Tested by materials testing agency Material Prüfanstalt (testing authority)



#### Edelstahl Rostfrei (rust-proof stainless steel)

Registered trademark of the EDELSTAHL ROSTFREI organization



#### Expansion roller

Only to be used with a POLY-PTX® expansion roller

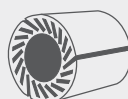

#### Eco Smart expansion roller

Only to be used with a POLY-PTX® Eco Smart expansion roller



#### Eco Smart adapter

Only to be used with the POLY-PTX® Eco Smart Adapter



**Don't settle  
for anything  
less than  
the best**

# ANGLE-GRINDING – CIRCULAR GRINDING

<b>CUTTING AND ROUGH GRINDING</b> .....	<b>24</b>	<b>POLISHING</b> .....	<b>62</b>
MAGNUM® RAZORCUT® .....	24	FIX BRIGHTEX® Disc .....	62
MAGNUM® FINECUT .....	25	FIX SuperPolish Disc .....	62
MAGNUM® TWINFLEX® .....	25	FIX Felt Disc .....	62
MAGNUM® FLEXO .....	26	MINI FIX BRIGHTEX® Disc .....	62
<b>GRINDING AND BLENDING</b> .....	<b>27</b>	MINI FIX SuperPolish Disc .....	62
<b>EISENBLÄTTER FLAP DISCS</b> .....	<b>27</b>	MINI FIX Felt Disc .....	62
Natural Fibre Compound .....	28	BRIGHTEX® Polishing Paste .....	63
TRIMFIX® Product Qualities .....	29	BRIGHTEX® Softclean Powder .....	64
<b>FLAP DISCS</b> .....	<b>30</b>	BRIGHTEX® Non-Scratch Cloth .....	64
TRIMFIX® HellFire® Ceramic Hybrid .....	30	Polishing Paste .....	65
TRIMFIX® BLACK MAMBA® .....	32	Pink Polishing Cream .....	65
TRIMFIX® ZIRCOPUR® .....	34	Microfibre Cloth .....	65
PLANTEX® Cool Top® Universal .....	36	<b>CLEANING</b> .....	<b>66</b>
MAGNUM® Cool Top® 8 .....	38	MAGNUM® Clean .....	66
MAGNUM® Cool Top® 5 .....	40	CLEAN Disc MCD .....	67
MAGNUM® Fillet Weld .....	42	FIX Clean Disc .....	67
MAGNUM® Ceramic .....	44	MINI FIX Clean Disc (flexible) .....	67
BLUE SHARK® Elastic .....	46	<b>POWER TOOLS</b> .....	<b>68</b>
TIGER SHARK® Elastic .....	48	VARILEX® WSF 1800 .....	68
ZIRCOTEX® Nylon Flat .....	50	VARILEX® WSF 1800 Professional Set .....	70
FIX HellFire® .....	51	QUICK-LOCK Cable .....	71
FIX Cool Top® .....	51	Special Protective Cover .....	71
MINI FIX Cool Top® Flap Disc .....	51	Machine Holder .....	72
<b>FIBRE DISCS</b> .....	<b>52</b>	Flexible Shaft .....	72
COLDSTEEL® Ceramic Fibre Disc .....	52	Case Study – Flap Discs .....	73
COLDSTEEL® Backing Plate .....	53	VARILEX® WSF 900 DUO .....	74
<b>FINISHING AND FINE GRINDING</b> .....	<b>54</b>	VARILEX® WSF 900 DUO Professional Set .....	76
TRIMFIX® Fleece Flap .....	54	QUICK-LOCK Cable .....	77
TRIMFIX® Fleece Flap 1FOR2 .....	55	Machine Holder .....	77
MAGNUM® Fleece Top .....	56	VARILEX® DUO Expansion Roller .....	78
MAGNUM® Top Mix .....	58	VARILEX® WSF 900 DUO Grinding Belt Roller .....	78
MAGNUM® Poly Magic Wheel .....	59	POLY-PTX® Special Adhesive Tape .....	78
MAGNUM® Unitized .....	60	VARILEX® WSF 900 DUO Grinding Wheel Mount with 19 mm Keyway Shaft .....	79
FIX SC Fleece Disc .....	61	VARILEX® WSF 900 Protective Cover .....	79
FIX Trizact™ Disc .....	61	Special Protective Cover .....	79
FIX AluPolish Disc .....	61	VARILEX® WSF 905 PROFESSIONAL .....	80
MINI FIX Trizact™ Disc .....	61	VARILEX® WSF 905 Metal Set .....	82
MINI FIX SC Fleece Disc .....	61	Special Protective Cover .....	83



**NEW**



Suitable for

**ALL METALS**

## MAGNUM<sup>®</sup> RAZORCUT<sup>®</sup>

Platinum longlife cutting disc for all metals

Revolutionary cutting disc which has unparalleled performance with up to 130 cuts (stainless steel pipe Ø 27 mm with 2 mm thick wall). Up to 50 % better performance compared to conventional products. Huge savings in working time due to considerably fewer disc changes. The distinctive qualities of this high-performance cutting disc are its aggressive cutting speed and yet long service life. All generally available metals can be precision cut and therefore often results in a rethink of users' material procurement and storage requirements.

### Technical Data:

Dimensions (mm)	Thickness (mm)	Max. speed (rpm)	Approved for (DIN EN 12413)	Shape	Hardness	Pkg. unit	Article number
Ø 125 x 22.2	1	12.200	80 m/sec		Hard	25	85122



Suitable for

**ALL METALS**

## MAGNUM® FINECUT

Premium cutting disc

Special high-performance disc for cutting thin-walled profiles and pipes for a premium quality job.



### Technical Data:

Dimensions (mm)	Thickness (mm)	Max. speed (rpm)	Approved for (DIN EN 12413)	Shape	Hardness	Pkg. unit	Article number
Ø 115 x 22.2	1	13,300	80 m/sec		Hard	25	85111
Ø 125 x 22.2	1	12,200	80 m/sec		Hard	25	85112



Suitable for

**ALL METALS**

## MAGNUM® TWINFLEX®

Cutting and rough grinding disc

The combination disc allows you to cut and rough grind using just one product. It is indispensable during jobs where workers are constantly changing discs over. Ideally suited for alternating cut-and-grind applications.



### Technical Data:

Dimensions (mm)	Thickness (mm)	Max. speed (rpm)	Shape	Hardness	Approved for (DIN EN 12413)	Pkg. unit	Article number
Ø 125 x 22.2	2.5	12,200		Hard	80 m/sec	25	85412





Suitable for

**ALL METALS**

## MAGNUM<sup>®</sup> FLEXO

Premium rough grinding disc

The outstanding features of this roughing disc are its great aggressivity, long service life and material removal performance. Ideal for stainless steel. Best suited for heavy-duty deburring jobs.



### Technical Data:

Dimensions (mm)	Thickness (mm)	Max. speed (rpm)	Approved for (DIN EN 12413)	Shape	Hardness	Pkg. unit	Article number
Ø 125 x 22.2	6	12,200	80 m/sec		Medium	10	85312



## UNRIVALED IN TECHNOLOGY AND PERFORMANCE

# Flap Discs

At the end of the 70s, Eisenblätter developed the first zirconium-based flap disc for high speed angle grinders. Our high quality standards and innovative strength have been setting the standards ever since and have been a critical factor in the development of flap discs. With 40 years' experience in the manufacture of flap discs, we have unrivaled technology and are now one of the biggest manufacturers in the world. In terms of material removal, service life and grinding quality, Eisenblätter flap discs are among the elite in the world.

**Simply superb**

Material removal, grinding quality and service life: for performance and a long service life – as well as the optimum grit composition to make the abrasive cloth – what you need above all is the right combination of flexible backing, flap angle, hard compression and gluing system.

**Green and completely safe**

At Eisenblätter, we attach the greatest value to user-friendly products and our green credentials when selecting our raw materials: we won't touch glass fibre, mineral fibres and epoxy resins but use sustainable and renewable raw materials for producing our flap discs. Right from the start, we've used food-grade special plastics for our backing plates. The development of the natural fibre compound backing plate has been an important contribution by Eisenblätter to conserving resources and reducing pollution. Another major contribution to safety, performance, service life and user-friendly products is the patented production process with its flexible anchoring of the abrasive cloth flaps which reduces vibration and noise considerably.

**Unique, revolutionary production process**

To meet the demands for high quality that we place on our flap discs, we've had to develop totally new production technologies. Eisenblätter flap discs do not have to be cured in temperatures of up to 140 °C.

With the Eisenblätter process, the necessary moisture remains in the abrasive cloth which means that it does not dry out and therefore cannot shred prematurely during grinding operations. The anchoring of the grinding flaps remains flexible which considerably reduces the noise generated and the vibration. In contrast to other manufacturing processes, the grinding flaps on Eisenblätter flap discs are compressed with the backing plate across their entire surface area throughout the curing process to produce a firm, compact grinding disc which is stable when exposed to vibration. This also supports the grinding grit and holds it securely. The service life of the grinding discs is therefore increased enormously.

**Tests and continuous operation trials provide quality assurance and the perfect conditions for new advanced developments.**

The grinding discs are tested to ensure that they can withstand the required speeds on centrifugal force testing machines. The equipment is able to test the discs at speeds of 30,000 rpm.

Continuous operation grinding tests are conducted on specially developed robotic systems and measure the material removal and service life of the flap discs. This is also where the suitability of new abrasive cloths is tested and the grinding properties on the materials for grinding are established.

**ONLY FROM EISENBLÄTTER!**

# Natural Fibre Compound

Flap discs with natural fibre compound backing plate

Here at Eisenblätter, we're particularly proud of our development and manufacture of high-tech flap discs. As one of the global pioneers of this product, we have set ourselves the mission for more than 40 years of helping people and their tools achieve the best possible results using modern and unrivaled raw materials.

### **TRIMFIX® backing plates – natural fibre instead of fibre glass**

Visually, it is similar to a fibre glass backing but it has numerous advantages:

- Viscoelastic – and therefore a larger grinding area
- Environmentally friendly due to containing CO<sub>2</sub>-neutral natural fibre material
- 100 % self-trimming
- Reduced dust emissions/no fibre glass dust generated
- Heat insulation properties
- Ultra-safe to work with
- Outstanding value for money
- Resistant to most chemicals
- Lower grinding temperature
- Great elastic properties

### **Grinds down to the last millimetre**

Backing plates made of natural fibre compound trim themselves during the grinding process. When the backing plate is trimmed it has as pleasant wood chip smell. Flap discs with natural fibre compound backing plate can be used right down to the last millimetre. Trimming leaves soft, harmless shavings which can be disposed of as household waste.

### **Smart Discs. More Benefits.**

Flap discs with natural fibre compound backing plates have damping and elastic properties which enhances their performance in grinding operations.

This elasticity of the backing plate allows for better adjustment and a larger contact surface area on the workpiece. The larger contact area allows higher material removal and better heat dissipation. Cooler grinding is important because it means the workpiece does not tarnish as easily and the abrasive cloth does not burn.

### **Strength and safety with FEM**

Natural fibre is extremely tear-resistant due to the fibre structure, as it is low in weight and provides maximum heat insulation. Backing plates made from natural fibre are designed using the Finite Element Method (FEM), this is so we can have outstanding strength and safety using the minimum amount of materials. All flap discs with natural fibre high-tech compound backing plates have been tested by materials testing agency, MPA Hanover. The flap discs are approved under DIN EN 13743 for speeds of up to 80 m/sec.

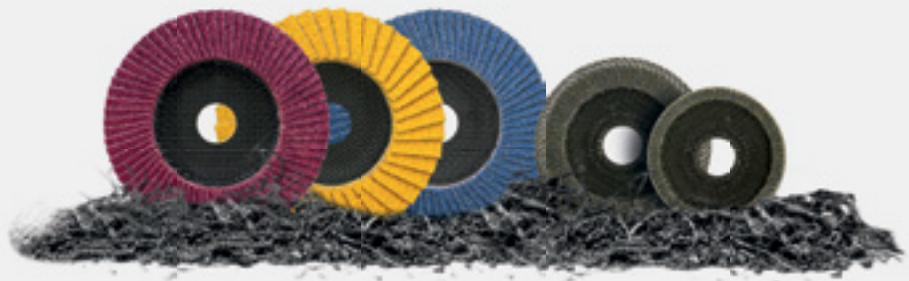



**ONLY FROM EISENBLÄTTER!**

# TRIMFIX® Product Qualities

Unique combination of high-tech abrasive cloth and natural fibre backing plate

An evolution, benefitting the environment, users and application technology. Previously, flap discs with backing plates made from natural fibre instead of plastic or pure fibre glass were unknown – except only from Eisenblätter.

**Natural fibre backing plates** – entirely free of fibre glass, sustainable and unrivaled. Reduces strain on the user and environmental pollution. 100 % developed and produced in Germany.

**Great cost-saving potential** – due to the disc's self-trimming capability 100 % of the disc can be used.



**High-tech abrasive cloth** – outstanding material removal and the ultimate in service life. Top quality raw materials are ready-made for all TRIMFIX® products.



Can be used on all generally available angle grinders. Works best on Eisenblätter VARILEX® angle grinders with tachometer



### Optimum adjustment to the workpiece due to viscoelastic backing plate

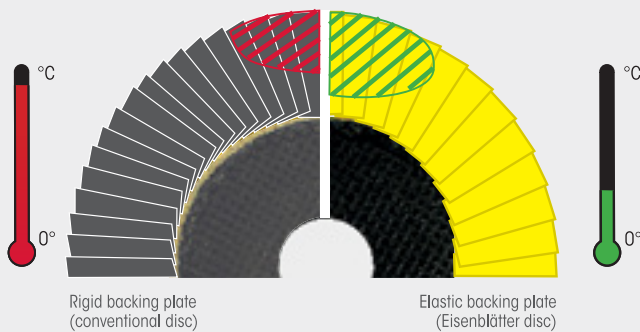

Due to Eisenblätter's patented production process, only Eisenblätter flap discs are truly flexible. As a result, not only can you work more efficiently but the grinding temperature is significantly reduced due to the larger contact surface area on the workpiece.

### Maximum material removal performance of one disc

Total material removed per flap disc in grams of steel/ST37

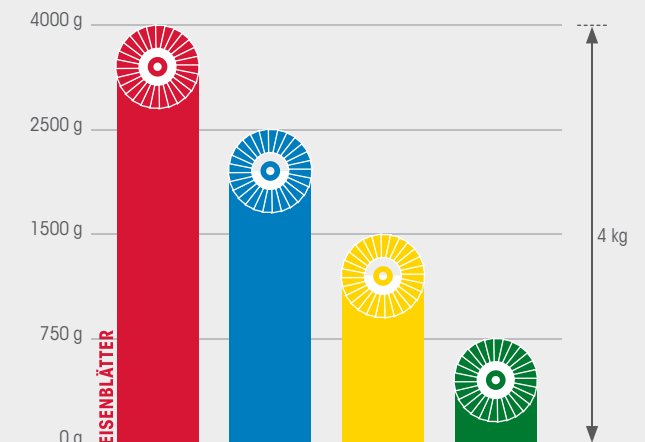

	Ø (Diameter)	Bulk purchase price	Material removed in 15 minutes	Approx. maximum overall performance
■ A – Top quality	125 mm	2.50 Euro	1000 g	> 4000 g
■ B – High quality	125 mm	2.40 Euro	750 g	2500 g
■ C – Average quality	125 mm	1.80 Euro	650 g	1500 g
■ D – Poor quality	125 mm	1.20 Euro	500 g	750 g



Suitable for

**ALL METALS**

# TRIMFIX<sup>®</sup> HellFire<sup>®</sup> Ceramic Hybrid



A world first! One disc for all metals.  
Forget everything you knew about grinding discs!

The TRIMFIX<sup>®</sup> HellFire<sup>®</sup> is one of the most modern and versatile flap discs in the world. Due to its unparalleled innovative ceramic hybrid technology, all metals can be machined in record time with just one grit. User-friendly since it contains no fibre glass components, and environmentally friendly since it uses CO<sub>2</sub>-neutral natural fibre components. Working hours and tool costs are halved – and all for absolutely outstanding value for money.

## FEATURES

- Multigrain (40/60) for all metals (such as steel, stainless steel, titanium, bronze, aluminium ...)
- New ceramic hybrid fabric allows grinding of workpieces with just one coarse to medium grit
- Reduced working steps due to grinding and finishing hybrid
- 40 grit grinding with 60 grit results
- Natural fibre backing plate minimises odours and has a vibration damping effect
- Backing plate can be fully trimmed – entire disc can be used
- Grinding transitions are particularly soft due to optimum adjustment to workpieces
- User-friendly since there are no glass fibre components
- Saves on the extra storage required for different grits



### Technical Data: TRIMFIX® HellFire®

Dimensions (mm)	Ideal speed (rpm)	Max. speed (rpm)	Approved for (DIN EN 13743)	Backing plate	Pkg. unit	Grit (K)	Article number
Ø 100 x 15.2	8,000 – 10,000	15,000	80 m/sec	Natural fibre	40	Multigrain 40/60	91520
Ø 100 x 16.0	8,000 – 10,000	15,000	80 m/sec	Natural fibre	40	Multigrain 40/60	91521
Ø 115 x 22.2	7,000 – 9,000	13,200	80 m/sec	Natural fibre	40	Multigrain 40/60	91530
Ø 125 x 22.2	6,000 – 8,000	12,200	80 m/sec	Natural fibre	40	Multigrain 40/60	91540
Ø 150 x 22.2	6,000 – 7,000	10,200	80 m/sec	Natural fibre	40	Multigrain 40/60	91547
Ø 178 x 22.2	5,000 – 6,000	8,500	80 m/sec	Natural fibre	40	Multigrain 40/60	91549



The TRIMFIX® HellFire® easily grinds all metals (such as aluminium, brass, steel, stainless steel, titanium and copper) consistently at maximum performance.

#### Ceramic hybrid fabric

One disc grinds all metal with one grit in excellent time and with a superb finish

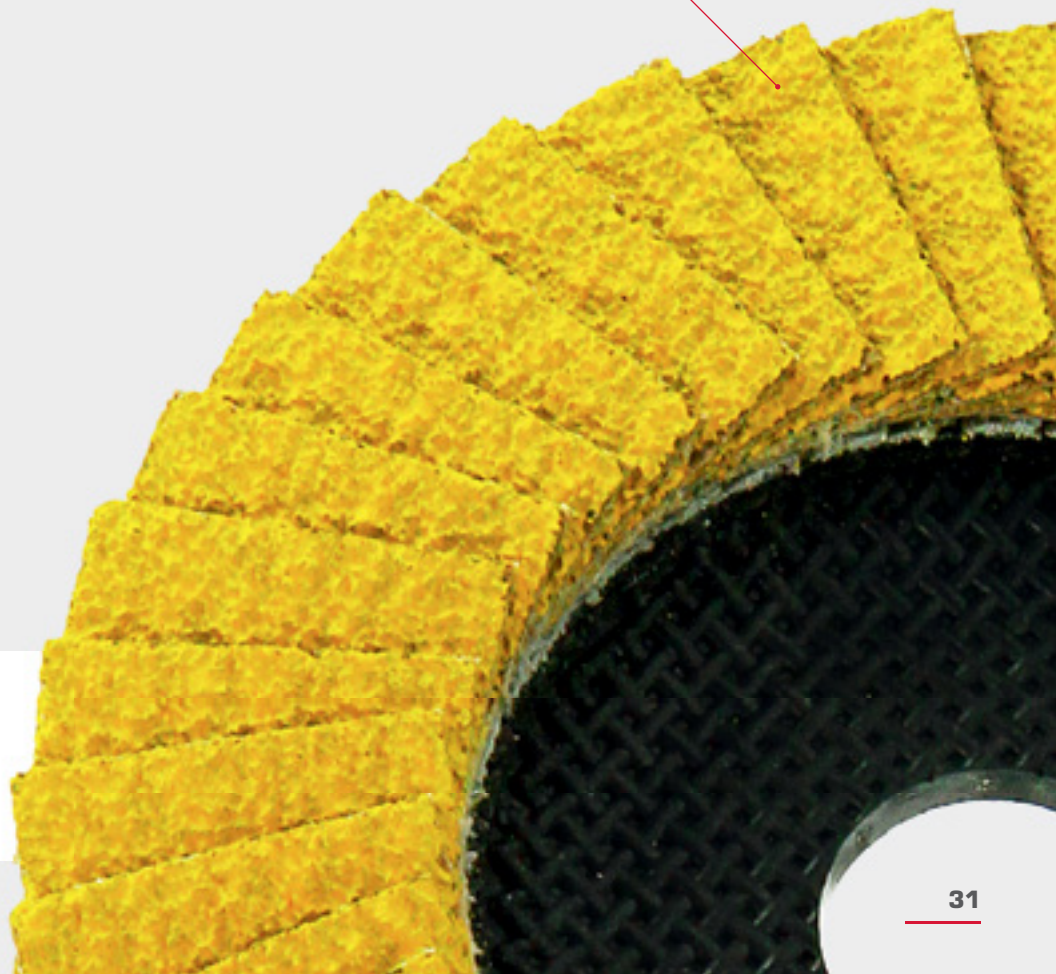

Even extremely hard and tough steel, such as Leopard 2 armored tank pipe, can be easily machined.

TRIMFIX® HellFire® guarantees first-rate results on all metals without loss of performance, even on titanium.



# GRINDING AND BLENDING

## FLAP DISCS



Suitable for

**STEEL · STAINLESS STEEL**

# TRIMFIX® BLACK MAMBA®



Probably the strongest flap disc in the world on steel!

The TRIMFIX® BLACK MAMBA® is a high-performance flap disc for steel. It is designed to provide an extremely long service life and deliver exceptional material removal for steel machining operations. The newly developed pure zirconium cloth with cooling agents make it ideal for machining all grades of steel through to stainless steel. The backing plate is made of natural fibre and is kind to users and the environment while adjusting flexibly to the workpiece, thus guaranteeing smooth blending transitions. As the TRIMFIX® BLACK MAMBA® can be trimmed, significant savings can be made in tool costs. Up to 4 kg of steel can be removed using just one Ø 125 mm grit 40 disc.

### FEATURES

- High-performance flap disc provides an exceptionally long service life and material removal on steel and stainless steel
- Newly developed pure zirconium fabric with cooling agents for guaranteed cool grinding and performance throughout its full service life
- Sets new performance standards with a nominal removal rate in excess of 4 kg of steel (depending on size and grit)
- Blending is particularly soft due to optimum adjustment to the workpiece
- Natural fibre compound backing plate is kind to the environment and to users (CO<sub>2</sub>-neutral)
- Natural fibre backing plate minimises odours and has a vibration damping effect
- Backing plate can be fully trimmed – entire disc can be used



### Technical Data: TRIMFIX® BLACK MAMBA®

Dimensions (mm)	Ideal speed (rpm)	Max. speed (rpm)	Approved for (DIN EN 13743)	Backing plate	Pkg. unit	Grit (K)	Article number
Ø 100 x 16.0	8,000 – 10,000	15,000	80 m/sec	Natural fibre	40	40	91704
						60	91706
Ø 115 x 22.2	7,000 – 9,000	13,200	80 m/sec	Natural fibre	40	40	91714
						60	91716
Ø 125 x 22.2	6,000 – 8,000	12,200	80 m/sec	Natural fibre	40	40	91724
						60	91726
Ø 150 x 22.2	6,000 – 7,000	10,200	80 m/sec	Natural fibre	40	40	91734
						60	91736
Ø 178 x 22.2	5,000 – 6,000	8,500	80 m/sec	Natural fibre	40	40	91744
						60	91746

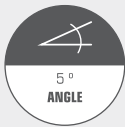

**100 % pure zirconium fabric**  
 Exceptionally long service life  
 and durability on steel and  
 stainless steel

This disc can remove up to one kilogram of steel in 15-20 minutes.  
 Also ideal for stainless steel due to its cool grinding properties.

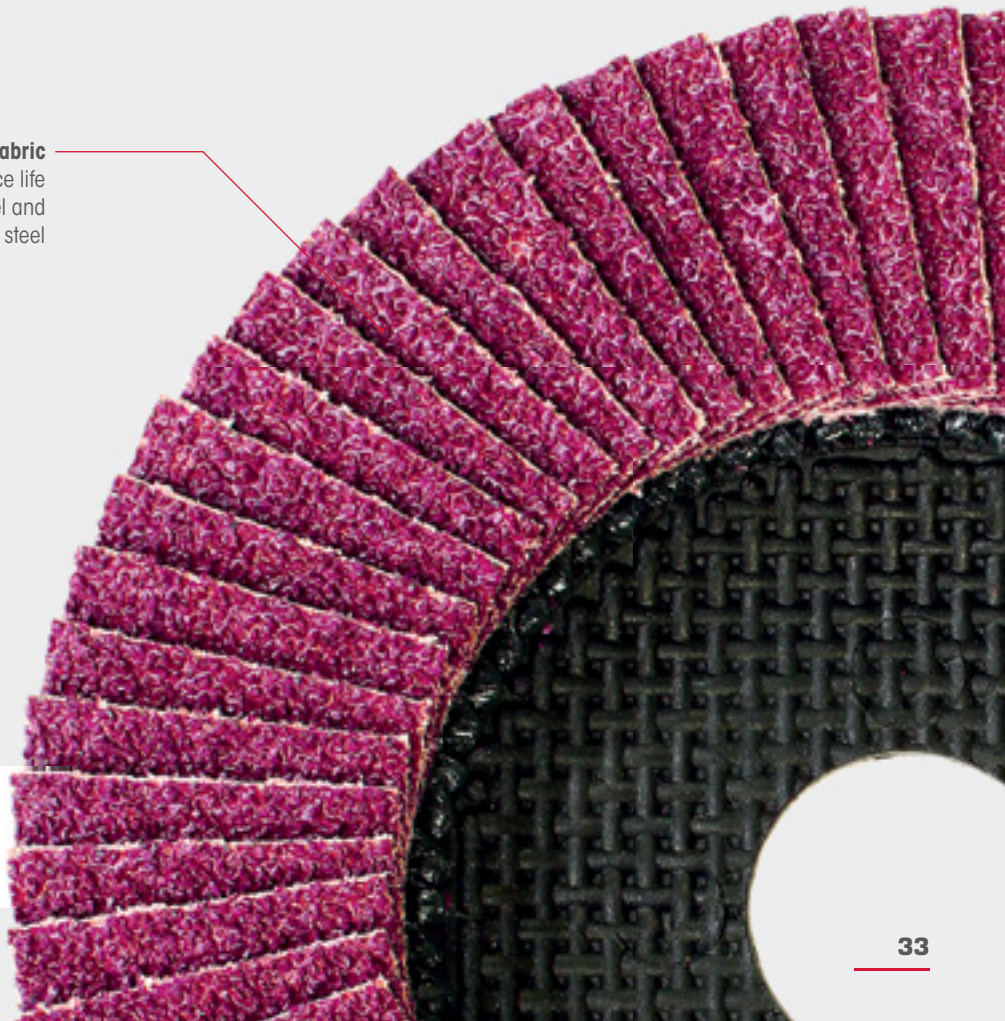



# GRINDING AND BLENDING

## FLAP DISCS

Suitable for

**STEEL · STAINLESS STEEL**

# TRIMFIX® ZIRCOPUR®

For universal grinding jobs on steel and stainless steel.

TRIMFIX® ZIRCOPUR® is a quality flap disc with revolutionary backing plate technology equipped with high-tech zirconium fabric for first-rate grinding results at an unbeatably affordable price for this superb quality.

The viscoelastic backing plate made of natural fibre compound allows the disc to adapt perfectly to the surface of the workpiece. Supplied in all generally available sizes and grits, it's a universal aid you can rely on.



### FEATURES

- High-tech zirconium fabric for high-performance grinding of steel and stainless steel
- Very good grinding results with unbeatable value for money
- Backing plate can be fully trimmed – entire disc can be used
- Natural fibre backing plate minimises odours and has a damping effect on vibration
- Blends are particularly soft due to optimum adjustment to workpieces
- Natural fibre compound backing plate is kind to the environment and to users (CO<sub>2</sub>-neutral)



### Technical Data: TRIMFIX® ZIRCOPUR®

Dimensions (mm)	Ideal speed (rpm)	Max. speed (rpm)	Approved for (DIN EN 13743)	Backing plate	Pkg. unit	Grit (K)	Article number
Ø 100 x 16.0	8,000 – 10,000	15,000	80 m/sec	Natural fibre	40	40	91504
						60	91506
						80	91508
						120	91509
Ø 115 x 22.2	7,000 – 9,000	13,200	80 m/sec	Natural fibre	40	40	91514
						60	91516
						80	91518
						120	91519
Ø 125 x 22.2	6,000 – 8,000	12,200	80 m/sec	Natural fibre	40	40	91524
						60	91526
						80	91528
						120	91529
Ø 150 x 22.2	6,000 – 7,000	10,200	80 m/sec	Natural fibre	40	40	91574
						60	91576
						80	91578
						120	91579
Ø 178 x 22.2	5,000 – 6,000	8,500	80 m/sec	Natural fibre	40	40	91580
						60	91581
						80	91582
						120	91583



**High-tech zirconium fabric**  
Extremely easy to use and cool grinding, even in continuous operations

**Dimensions/grits**  
Supplied in all generally available industrial sizes and grits.

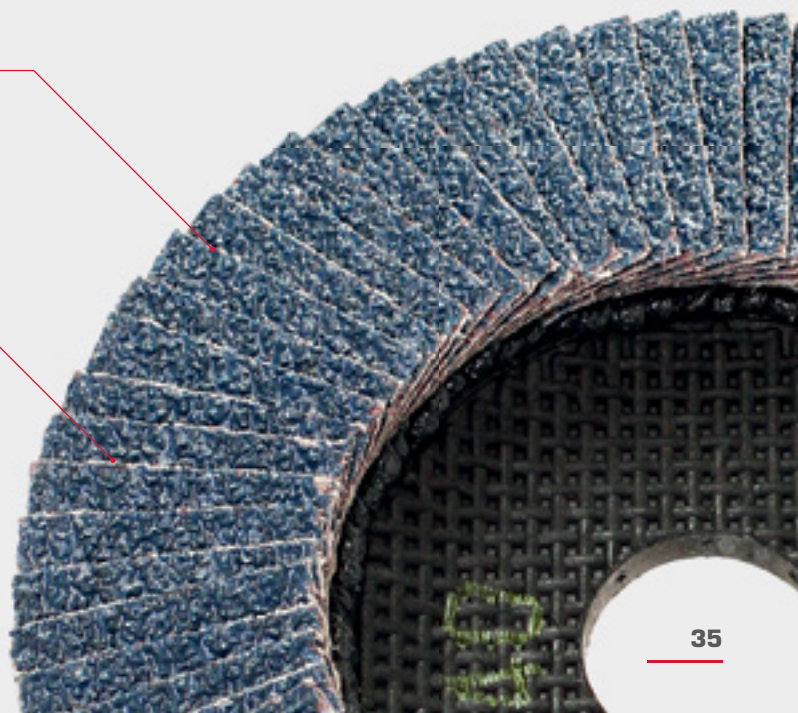





Suitable for

**STEEL · STAINLESS STEEL · NON-FERROUS METALS · HARD PLASTICS**

# PLANTEX<sup>®</sup> Cool Top<sup>®</sup> Universal



Long-life high-tech pure zirconium disc with active grinding agents

Since Eisenblätter brought the first flap disc with pure zirconium cloth onto the market for high-speed angle grinders at the end of the 70s, we have had a decisive influence on the development of the flap disc time and again with our innovative ideas. The natural fibre compound we use for our backing plates is the ideal material for the job. With the development of new backing plates made from natural fibre compound, PLANTEX<sup>®</sup> Cool Top<sup>®</sup> Universal was the first flap disc to be supplied throughout the world with a backing plate made from renewable hemp with polypropylene as the binding agent.

## FEATURES

- Ultra-safe to work with
- Conserves resources and is environmentally sustainable
- Reduces pollution to a minimum from manufacture to disposal
- Absorbs heat (hollow fibre insulation reduces the temperature during grinding operations)
- Disc self-trims (i.e. the backing plate is automatically reduced during grinding operations) or can be gently machined to trim it down
- Easy disposal
- Superb insulating, damping and noise reducing qualities
- Excellent strength with low energy consumption
- High level of stability while remaining flexible
- Resistant to most chemicals
- CO<sub>2</sub> neutral





### Technical Data: PLANTEX® Cool Top® Universal

Dimensions (mm)	Ideal speed (rpm)	Max. speed (rpm)	Approved for (DIN EN 13743)	Backing plate	Pkg. unit	Grit (K)	Article number
Ø 115 x 22.2	7,000 – 9,000	13,200	80 m/sec	Natural fibre	40	40	92140
						60	92160
						80	92180
						120	92190
Ø 125 x 22.2	6,000 – 8,000	12,200	80 m/sec	Natural fibre	40	40	92240
						60	92260
						80	92280
						120	92290
Ø 178 x 22.2	5,000 – 6,000	8,500	80 m/sec	Natural fibre	40	40	92340
						60	92360
						80	92380
						120	92390



FREE OF FIBRE GLASS



5° ANGLE



PATENTED



REDUCE NOISE



FLEXIBLE



NATURAL FIBRE



TRIMMABLE



COPYRIGHTED DESIGN



STAHL STEEL



STAINLESS STEEL



NON-FERROUS METALS



HARD PLASTICS



MPA tested

**100 % pure zirconium with grinding additives**  
 For an extremely wide range of application with outstandingly easy processing of material for grinding

**Approx. content ratio (proportions in backing plate)**

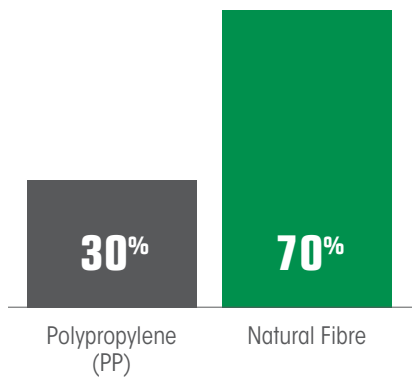

# GRINDING AND BLENDING

## FLAP DISCS

NEW

Suitable for

**STEEL · STAINLESS STEEL**

# MAGNUM<sup>®</sup> Cool Top<sup>®</sup> 8

ZIRCOPUR<sup>®</sup> high-performance flap disc with ultra-high abrasive cloth content

The new formulation we have developed in the 100 % pure zirconium sector on a 100 % cotton backing gives MAGNUM<sup>®</sup> flap discs, under the name of MAGNUM<sup>®</sup> Cool Top<sup>®</sup> 8, an even wider range of applications on most types of steel and delivers over 30 % more performance than the MAGNUM<sup>®</sup> Cool Top<sup>®</sup> 5!



### FEATURES

- Longer, faster and more efficient grinding
- Abrasive cloth contains 100 % pure zirconium
- Cooling agents for an extremely high degree of material removal
- For universal use with steel, cast iron and stainless steel. For surface and edge grinding, coarse and intermediate grinding, processing fillet welds, removing rust, deburring and cleaning castings
- Slightly angled (5° angle)
- Backing plate made from specially developed food-grade, flexible plastic: Easy to trim and has a damping effect on vibration
- The high degree of material removed and excellent service life make the MAGNUM<sup>®</sup> Cool Top<sup>®</sup> 8 not just better but also an absolutely better value-for-money solution compared to conventional flap discs





### Technical Data: MAGNUM® Cool Top® 8

Dimensions (mm)	Ideal speed (rpm)	Max. speed (rpm)	Approved for (DIN EN 13743)	Backing plate	Pkg. unit	Grit (K)	Article number
Ø 115 x 22.2	7,000 – 9,000	13,200	80 m/sec	Special flexible plastic	40	40	96464
						60	96466
						80	96468
						120	96469
Ø 125 x 22.2	6,000 – 8,000	12,200	80 m/sec	Special flexible plastic	40	40	96474
						60	96476
						80	96478
Ø 178 x 22.2	5,000 – 6,000	8,500	80 m/sec	Special flexible plastic	40	40	96494
						60	96496
						80	96498
						120	96499



### Steel removed in 15 mins (steel/ST37)

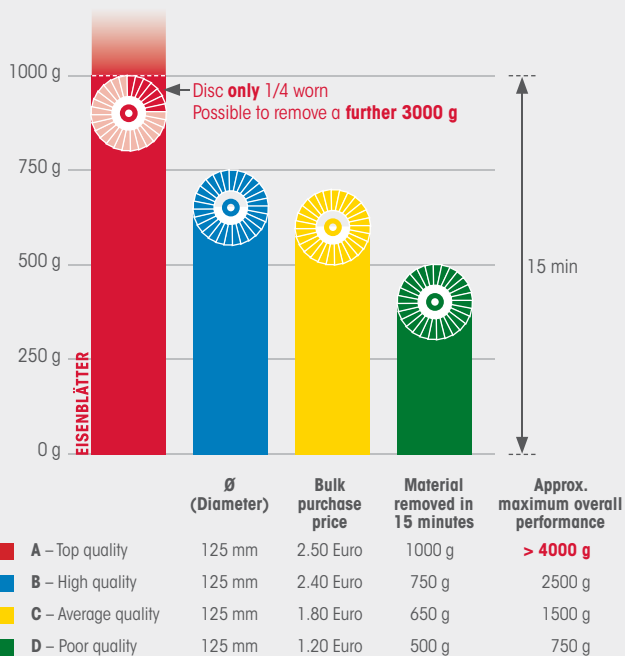

FOR MORE INFORMATION, SEE PAGE 73.

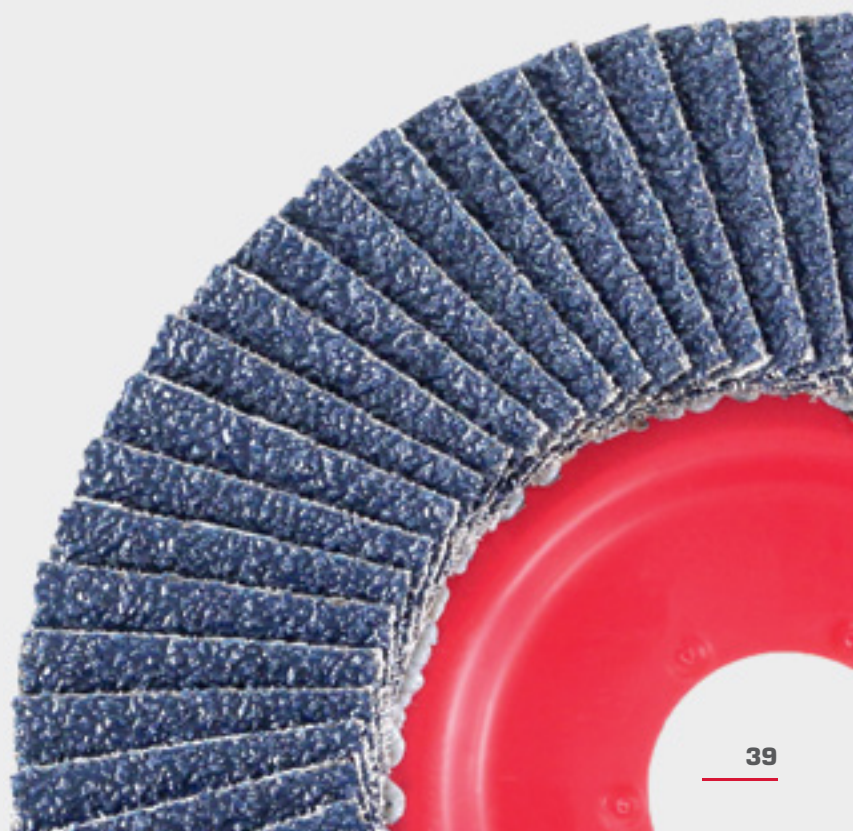

# GRINDING AND BLENDING

## FLAP DISCS

Suitable for

**STEEL · STAINLESS STEEL**

# MAGNUM<sup>®</sup> Cool Top<sup>®</sup> 5

ZIRCOPUR<sup>®</sup> high-performance flap disc with ultra-high abrasive cloth content



### FEATURES

- Longer, faster and more efficient grinding
- The ultra-powerful zirconium flap disc with backing plate made from food-grade plastic
- Proven abrasive formulation (RZ zirconium plus cooling agent) guarantees huge benefits compared to conventional flap discs: often up to 50 % faster in removing material, many times the length of service life compared to conventional flap discs and cooler grinding due to additional cooling agents
- For universal use with steel, cast iron and stainless steel. For surface and edge grinding, coarse and intermediate grinding, processing fillet welds, removing rust, deburring and cleaning castings
- Replaces not only fibre discs but also rough grinding discs in many companies
- The high degree of material removed and excellent service life make the MAGNUM<sup>®</sup> Cool Top<sup>®</sup> 5 not just better but also an absolutely better value-for-money solution compared to conventional flap discs
- Backing plate made from specially developed food-grade, flexible plastic: easy to trim and has a damping effect on vibration



### Technical Data: MAGNUM® Cool Top® 5

Dimensions (mm)	Ideal speed (rpm)	Max. speed (rpm)	Approved for (DIN EN 13743)	Backing	Pkg. unit	Grit (K)	Article number
Ø 115 x 22.2	7,000 – 9,000	13,200	80 m/sec	Special flexible plastic	40	40	96140b
						60	96160b
						80	96180b
						120	96190b
Ø 125 x 22.2	6,000 – 8,000	12,200	80 m/sec	Special flexible plastic	40	40	96240b
						60	96260b
						80	96280b
						120	96290b
Ø 178 x 22.2	5,000 – 6,000	8,500	80 m/sec	Special flexible plastic	40	40	96340b
						60	96360b
						80	96380b



### Steel removed in 15 mins (steel/ST37)

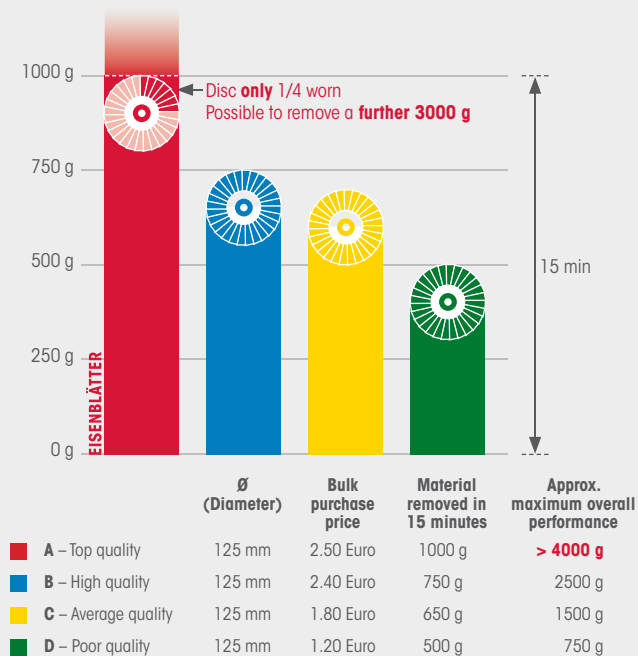

FOR MORE INFORMATION, SEE PAGE 73.





Suitable for

**STEEL · STAINLESS STEEL**

# MAGNUM<sup>®</sup> Fillet Weld



High performance flap disc with an extremely high proportion of abrasive cloth made from pure zirconium for maximum service life and material removal. Ideal for heavy-duty grinding tasks, such as in shipyards and steel construction. It is the problem solver for corners due to its large flap overhang.

## FEATURES

- Perfect for low-cost treatment of welds in corners, on edges and fillet welds
- The large flexible overhang of the grinding flaps over the backing plate adjusts perfectly to the shape of a fillet weld
- Smooth blends on corner welds
- Clean, groove-free results
- Same grinding performance and service life as the MAGNUM<sup>®</sup> Cool Top<sup>®</sup> 5
- Backing plate made from specially developed food-grade, flexible plastic: easy to trim and has a damping effect on vibration
- Proven abrasive formulation (RZ zirconium plus cooling agent) guarantees huge benefits compared to conventional flap discs: often up to 50 % faster in removing material, many times the length of service life compared to conventional flap discs and cooler grinding due to additional cooling agents



### Technical Data: MAGNUM® Fillet Weld

Dimensions (mm)	Ideal speed (rpm)	Max. speed (rpm)	Approved for (DIN EN 13743)	Backing plate	Pkg. unit	Grit (K)	Article number
Ø 125 x 22.2	6,000 – 8,000	12,200	80 m/sec	Special flexible plastic	10	40	96284
						60	96286
						80	96288
						120	96289

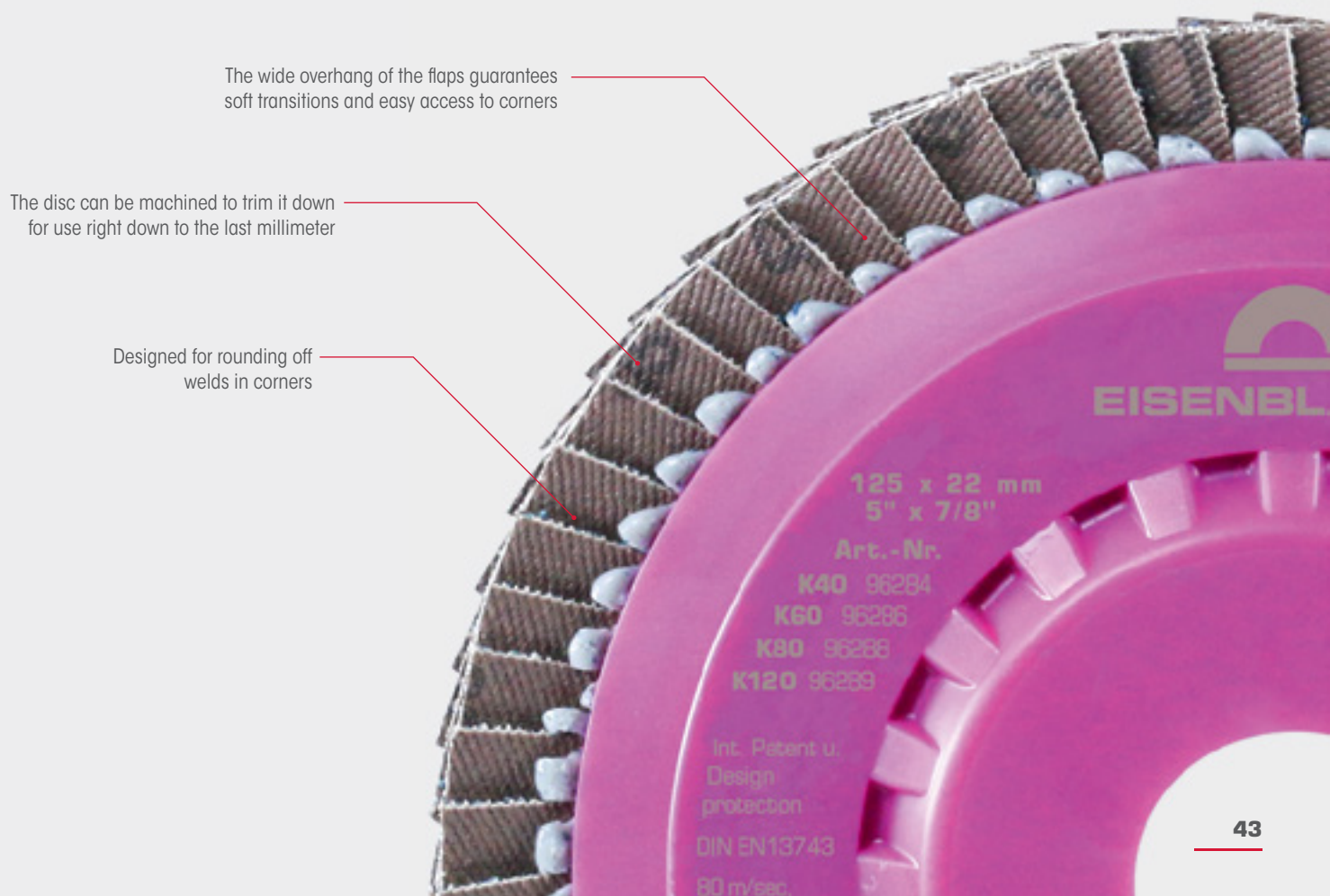
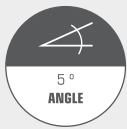

The wide overhang of the flaps guarantees soft transitions and easy access to corners

The disc can be machined to trim it down for use right down to the last millimeter

Designed for rounding off welds in corners

EISENBL

125 x 22 mm  
5" x 7/8"

Art.-Nr.

K40 96284

K60 96286

K80 96288

K120 96289

Int. Patent u.  
Design  
protection

DIN EN 13743

80 m/sec.



# GRINDING AND BLENDING

## FLAP DISCS

Suitable for

**ALL METALS**

# MAGNUM<sup>®</sup> Ceramic

Ceramic high-performance flap disc with exceptional grinding performance, for universal use on all metals and hard-to-grind metals.



### FEATURES

- Advanced high-performance ceramic disc for maximum power
- Extremely time-saving for the removal of material on stainless steel, steel, titanium and bronze
- Exceptionally cool grinding behavior prevents heat discolouration
- Backing plate made from specially developed food-grade, flexible plastic: easy to trim and has a damping effect on vibration
- Backing can be trimmed allowing all grinding flaps to be fully utilised
- Damping and noise reducing qualities due to elasticity



### Technical Data: MAGNUM® Ceramic

Dimensions (mm)	Ideal speed (rpm)	Max. speed (rpm)	Approved for (DIN EN 13743)	Backing plate	Pkg. unit	Grit (K)	Article number
Ø 115 x 22.2	7,000 – 9,000	13,200	80 m/sec	Special flexible plastic	40	40	96614
						60	96616
						80	96618
Ø 125 x 22.2	6,000 – 8,000	12,200	80 m/sec	Special flexible plastic	40	40	96624
						60	96626
						80	96628
Ø 178 x 22.2	5,000 – 6,000	8,500	80 m/sec	Special flexible plastic	40	40	96644
						60	96646
						80	96648

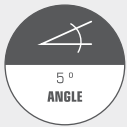

**New ceramic formulation**  
High grinding performance  
on all metals





# GRINDING AND BLENDING

## FLAP DISCS

Suitable for

**STEEL · CAST IRON · STAINLESS STEEL**

# BLUE SHARK<sup>®</sup> Elastic

Highly flexible flap disc with zirconium cooling layers for extra smooth and flat finishes, ideally suited for use in sheet metal working, for example, and has a particularly long service life and superb cooling effect.



### FEATURES

- Highly flexible, durable flap disc with a low overall height
- For exceptionally smooth and flat finishes, such as when surface grinding large constructs
- The high elasticity of the backing plate allows the grinding disc to adjust superbly to the workpiece surface. The effective contact surface area is larger, ensuring that the rate of heat dissipation is considerably greater
- Prevents discolouration of workpiece to a large extent
- Ideal for grinding sheet metal due to its cooler grinding behavior
- Backing plate made from specially developed food-grade, flexible plastic, flexible design, easy to trim and has a damping effect on vibration
- Markedly longer service life compared to conventional flap discs



### Technical Data: BLUE SHARK® Elastic

Dimensions (mm)	Ideal speed (rpm)	Max. speed (rpm)	Approved for (DIN EN 13743)	Backing plate	Pkg. unit	Grit (K)	Article number
Ø 115 x 22.2	7,000 – 9,000	13,200	80 m/sec	Special flexible plastic	40	40	94140e
						60	94160e
						80	94180e
						120	94190e
Ø 125 x 22.2	6,000 – 8,000	12,200	80 m/sec	Special flexible plastic	40	40	94240e
						60	94260e
						80	94280e
						120	94290e
Ø 178 x 22.2	5,000 – 6,000	8,500	80 m/sec	Special flexible plastic	40	40	94340
						60	94360



The disc can be machined to trim it down for use right down to the last millimetre

Large contact area due to high elasticity

High rate of material removal due to new abrasive formulation

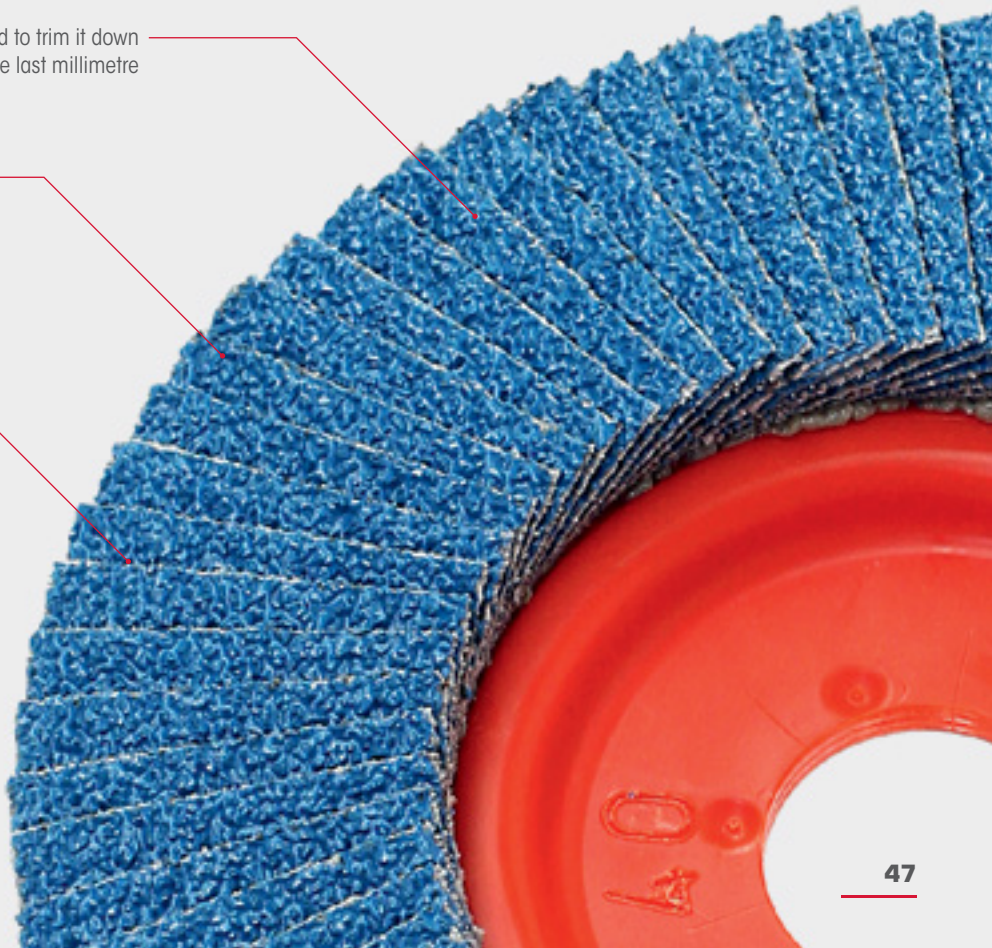



# GRINDING AND BLENDING

## FLAP DISCS

Suitable for

**ALUMINIUM · STEEL · NON-FERROUS METALS**

# TIGER SHARK® Elastic

Highly flexible flap disc with a top quality special corundum compound and cooling effect for smooth and even grinding finishes. Ideal for grinding aluminium.



### FEATURES

- Grinding disc does not smear when grinding aluminium
- TIGER SHARK® + ALU-FIX ÖL result in up to 300 % more material removal capacity and three times longer service life
- Visibly better grinding results
- Highly flexible backing plate adjusts to the workpiece.
- High material removal capacity at a reduced grinding temperature
- Specially developed corundum abrasive cloth
- Superb grinding performance at low tool cost
- Ideal for curved surfaces, for example, in car bodywork, motor vehicle workshops and railway carriage construction
- Backing plate made from specially developed food-grade, flexible plastic, flexible design, easy to trim and has a damping effect on vibration

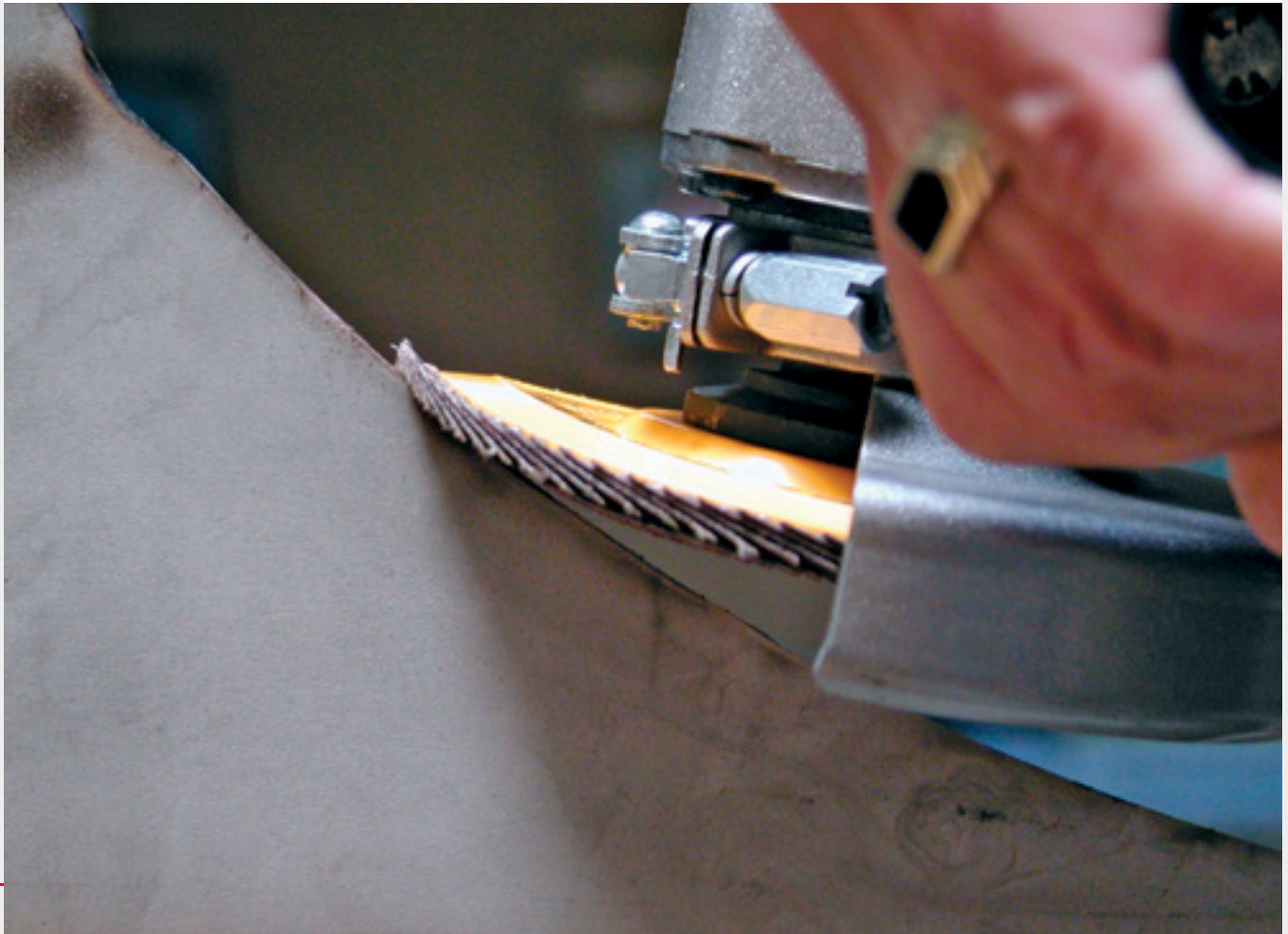



### Technical Data: TIGER SHARK® Elastic

Dimensions (mm)	Ideal speed (rpm)	Max. speed (rpm)	Approved for (DIN EN 13743)	Backing plate	Pkg. unit	Grit (K)	Article number
Ø 115 x 22.2	7,000 – 9,000	13,200	80 m/sec	Special flexible plastic	40	40	94145e
						60	94165e
						80	94185e
						120	94195e
Ø 125 x 22.2	6,000 – 8,000	12,200	80 m/sec	Special flexible plastic	40	40	94245e
						60	94265e
						80	94285e
						120	94295e
Ø 178 x 22.2	5,000 – 6,000	8,500	80 m/sec	Special flexible plastic	40	40	94345
						60	94365

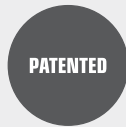

The disc can be machined to trim it down for use right down to the last millimetre – ideal for working with aluminium

Large contact area due to high elasticity

**TIGER SHARK® + ALU-FIX ÖL**  
Results in up to 300 % more material removal capacity and up to three times longer service life.



# GRINDING AND BLENDING

## FLAP DISCS

Suitable for

**STEEL · STAINLESS STEEL · CAST IRON · NON-FERROUS METALS · ALUMINIUM**

# ZIRCOTEX<sup>®</sup> Nylon Flat

The legendary flat flap disc.  
Ideal for grinding welds for steel fabrication.



### FEATURES

- Extremely-wide double flaps (30 mm with Ø 115 mm) made from zirconium improve the heat distribution and increase the cooling effect
- Around 50 times longer service life than conventional fibre discs
- For rough grinding, smoothing, cleaning weld seams and spot welds
- Very large abrasive surface for a long service life
- Flat contact area for perfect weld blending on outer edges. Ideal for use in constructing tanks and enclosures
- Used as an abrasive for the ROLEI EF 115

### Technical Data::

Dimensions (mm)	Ideal speed (rpm)	Max. speed (rpm)	Approved for (DIN EN 13743)	Backing plate	Pkg. unit	Grit (K)	Article number
Ø 115 x 22.2	7,000 – 8,000	13,200	80 m/sec	Polyamide	10	40	21040
						50	21050
						60	21060
						80	21080
						120	21120



Suitable for

**ALL METALS**

### **FIX HellFire®**

**With a new type of highly aggressive ceramic-hybrid abrasive cloth:**

Saves considerably on time, prevents heat deformation and discolouration and provides 40 grit grinding with 60 grit results. Adjusts easily to workpieces of any shape – delivers best grinding results due to high degree of elasticity.

**SEE PAGE 87 FOR MORE DETAILS.**



Suitable for

**STEEL · STAINLESS STEEL · NON-FERROUS METALS**

### **FIX Cool Top®**

With Cool Top® pure zirconium abrasive. Superb material removal performance, extremely long service life with uniformly clean results and no discolouration of the material or smearing. Highly flexible – adjusts to workpieces of any shape.

**SEE PAGE 87 FOR MORE DETAILS.**



Suitable for

**STEEL · STAINLESS STEEL · NON-FERROUS METALS**

### **MINI FIX Cool Top® Flap Disc**

Quick-change mini zirconium flap disc. Ultra-long service life, high rate of material removal, a uniform, clean result and no discolouration of the material and adjusts to the workpiece to best effect.

**SEE PAGE 95 FOR MORE DETAILS.**

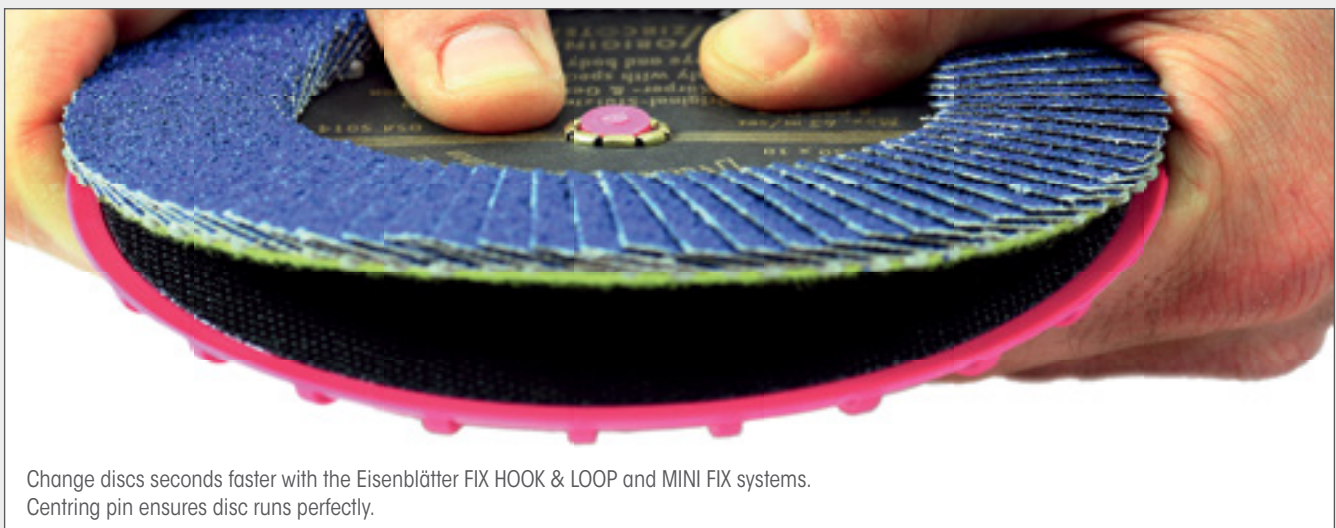

Change discs seconds faster with the Eisenblätter FIX HOOK & LOOP and MINI FIX systems. Centring pin ensures disc runs perfectly.





Suitable for

**STEEL · STAINLESS STEEL**

# COLDSTEEL<sup>®</sup> Ceramic Fibre Disc



High-tech ceramic fibre disc which has significantly more self-sharpening edges due its ultra-fine grit and crystal structure. Therefore, it exceeds the performance of conventional fibre discs due its immense rate of material removal.

### FEATURES

- Top ceramic quality
- Ultra-fine grit and crystal structures provide for significantly more self-sharpening edges and a huge improvement in material removal
- Even in the coarse grit range, at a high rate of material removal, the size of the chip particles remains relatively small, preventing damage from the afterglow effect when there are large metal particles
- The finer grinding result on the surface of the workpiece reduces the frequent need to finish the piece using finer grits
- Packed in a practical resealable bag
- Self-sharpening ceramic grit

### Technical Data:

Dimensions (mm)	Approved for (DIN EN 13743)	Pkg. unit	Grit (K)	Article number
Ø 115 x 22.2	80 m/sec	25	36	82004
			60	82007
			80	82008
			120	82009
Ø 125 x 22.2	80 m/sec	25	24	82013
			36	82014
			60	82017
			80	82018
			120	82019
Ø 180 x 22.2	80 m/sec	25	24	82023
			36	82024
			60	82027
			80	82028
			120	82029



NEW

Suitable for

**FIBRE DISCS**

# COLDSTEEL® Backing Plate

Specially developed heat-resistant backing plate for fibre discs. The ribs on the underside dissipate heat for cooler grinding.

**FEATURES**

- Heat-resistant plastic with a high fibre content for dimensional stability, even during continuous use
- Aluminium clamping nut – no rust

**Technical Data:**

Dimensions (mm)	Mount	Max. speed (rpm)	Approved for (DIN EN 13743)	Pkg. unit	Article number
Ø 113	M14 thread	13,000	80 m/sec	1	82001
Ø 123	M14 thread	12,000	80 m/sec	1	82011
Ø 173	M14 thread	8,500	80 m/sec	1	82021
Ø 113	5/8" thread	13,000	80 m/sec	1	82002
Ø 123	5/8" thread	12,000	80 m/sec	1	82012
Ø 173	5/8" thread	8,500	80 m/sec	1	82022





Suitable for

**ALL METALS · WOOD**

## TRIMFIX® Fleece Flap

Highly flexible SC fleece flap disc.  
Ideal for fine machining weld seams.



### FEATURES

- Highly flexible, non-woven fleece flap disc with a low overall height
- Top quality surface-conditioning (SC) fleece material for an ultra-long service life
- Ideal for subsequent high gloss and mirror finish polishing of stainless steel
- Ideal for rounding off internal edges
- For deburring, fine grinding, pipe finishing, TIG weld grinding and intermediate grinding
- Large contact area for improved heat dissipation
- In all fine grinding grit sizes right through to high gloss
- Natural fibre compound backing plate is kind to the environment and to users (CO<sub>2</sub>-neutral)

### Technical Data::

Dimensions (mm)	Ideal speed (rpm)	Max. speed (rpm)	Approved for (DIN EN 13743)	Ideal for	Backing plate	Pkg. unit	Grit (Fleece)	Grit (K)	Colour (Fleece)	Article number
Ø 125 x 22.2	2,000 – 5,000	12,200	80 m/sec	Variable-speed angle grinders	Natural fibre	10	Coarse	80	Brown	96741
							Medium	180	Red	96742
							Fine	280	Blue	96743

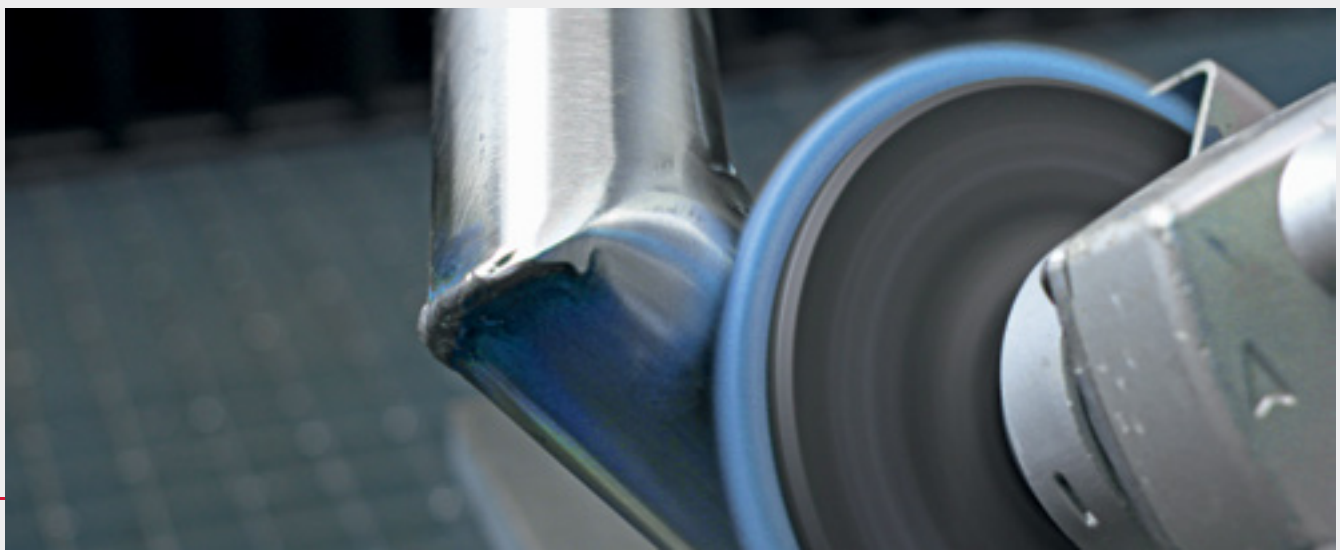
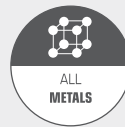





Suitable for

**ALL METALS · WOOD**

## TRIMFIX® Fleece Flap 1FOR2



2 operations with one disc: weld seam removal and fine grinding in one operation (e.g. on stainless steel pipes)

The newly developed SC (surface-conditioning) fleece fabric by Eisenblätter allows weld seams and spot welds on stainless steel pipes and similar to be removed, while delivering fine grinding and clean and "soft" blends. These benefits were previously only available by using two-component flap discs (SC fleece and abrasive fabric) but the potential disadvantage was uneven wear of the flaps and therefore variable results. With the worldwide first, TRIMFIX® Fleece Flap 1FOR2®, on the other hand, has a more uniform result and can be achieved with significant potential savings.

### FEATURES

- Ideal for gently leveling weld seams on pipes
- For removing edges, cast cleaning, etc.
- For coarse and fine grinding jobs in one operation
- Effortlessly removes scale due to its open grit structure
- Uniform results
- Ideal for entry into ultra-fine grinding
- Easy and clean removal of medium-depth scratches and other damage
- Cheaper than comparable two-component discs
- "Soft" blends achieved with cool grinding behaviour (no discolouration)
- Natural fibre compound backing plate is kind to the environment and to users (CO<sub>2</sub>-neutral)

### Technical Data:

Dimensions (mm)	Ideal speed (rpm)	Max. speed (rpm)	Approved for (DIN EN 13743)	Backing plate	Ideal for	Pkg. unit	Grit (Fleece)	Grit (K)	Colour (Fleece)	Article number
Ø 125 x 22.2	2,000 – 5,000	12,200	80 m/sec	Natural fibre	Variable-speed angle grinders	10	1FOR2 (extra coarse)	40	Green	96740

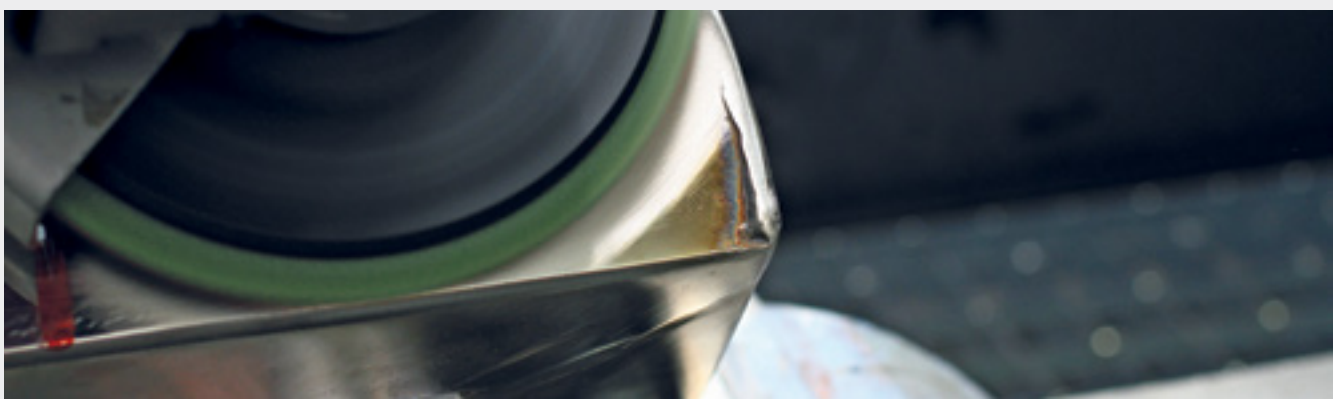

Suitable for

**ALL METALS · WOOD · HARD PLASTICS**

# MAGNUM<sup>®</sup> Fleece Top

Versatile fleece disc manufactured from compressed fleece that has been expanded for fine finishes.

For metalworking jobs such as grinding, fine grinding, smoothing and polishing also for removing scale, oxides, scratches, rust, burr and paint. Furthermore, it cleans and smooths wood and plastics.



### FEATURES

- Up to 8 times longer service life than conventional fleece discs
- Consistently clean results
- Perfect for smoothing tool surfaces
- Replaces wire brushes, sandpaper and rubber grinding wheels
- Also ideal for cleaning and smoothing wood and plastic
- The special self-cleaning fleece mixture prevents glazing and smearing
- Has a 30 mm width silicon carbide fleece ring for a significantly longer service life
- Backing plate made from specially developed food-grade, flexible plastic: easy to trim and has a damping effect on vibration



## Technical Data: MAGNUM® Fleece Top

Dimensions (mm)	Ideal speed (rpm)	Max. speed (rpm)	Material thickness (mm)	Backing plate	Ideal for	Pkg. unit	Grit (K)	Article number
Ø 115 x 22.2	2,000 – 5,000	8,000	15	Special flexible plastic	Variable-speed angle grinders	5	80	96710
							180	96711
							280	96712
							400	96713
							600	96714
							900	96715

### Roughness (Peak to Valley heights):

Average Roughness (Rz) when used on stainless steel	80	180	280	400	600	900
Expressed in $\mu$	6.10 $\mu$	4.16 $\mu$	2.78 $\mu$	2.74 $\mu$	2.26 $\mu$	1.66 $\mu$
Average Roughness (Rz) when used on aluminium	80	180	280	400	600	900
Expressed in $\mu$	9.26 $\mu$	5.63 $\mu$	3.85 $\mu$	3.78 $\mu$	2.68 $\mu$	2.58 $\mu$

Rz = Roughness value

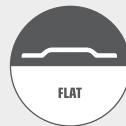

### Sample applications:



Stainless steel: for cleaning and removing minor scratches



Steel: for fine grinding, deburring and removing rust



Aluminium: for cleaning and fine grinding



Wood: for smoothing the wood fibres after removing the paint using FIX Clean or MAGNUM® Clean

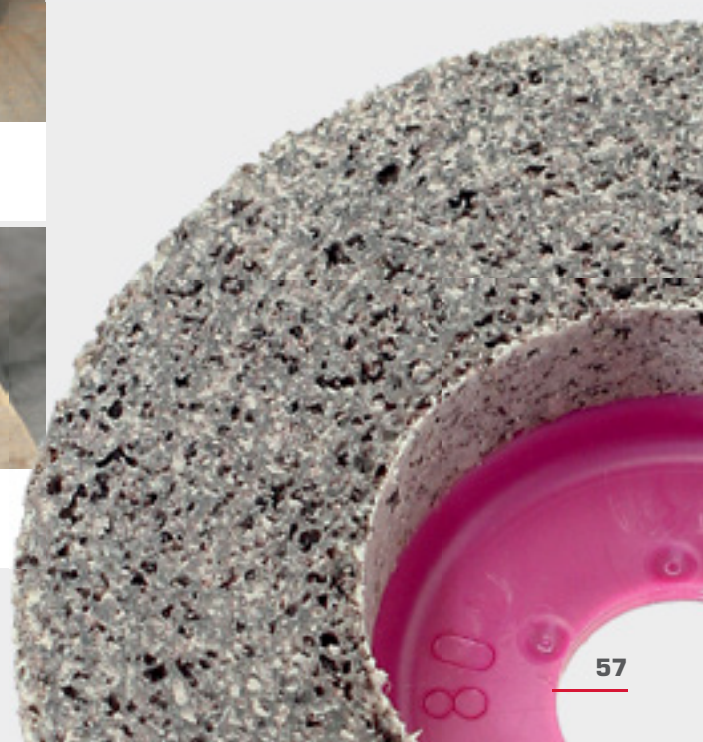



Suitable for

**STEEL · STAINLESS STEEL · NON-FERROUS METALS**

## MAGNUM<sup>®</sup> Top Mix

Combination fleece disc – complete 2 operations at once!  
Higher rate of material removal with fine grinding results.



### FEATURES

- Significantly more aggressive than conventional fleece discs
- This coordinated combination of grinding flaps alternating with compressed fleece produces a better grinding performance, longer service life and a fine grinding result
- Ideal for finely deburring perforated sheet metal
- For preparatory grinding and fine grinding of spot welds and deep scratches on stainless steel, steel and non-ferrous metals
- Ideal for reworking corners – especially after using MAGNUM<sup>®</sup> fillet weld. Effortlessly removes unevenness, chatter marks, scratches etc. with a fine grinding result, even in corners
- Backing plate made from specially developed food-grade, flexible plastic: easy to trim and has a damping effect on vibration

### Technical Data::

Dimensions (mm)	Ideal speed (rpm)	Max. speed (rpm)	Approved for (DIN EN 13743)	Material thickness (mm)	Backing plate	Ideal for	Pkg. unit	Grit (K)	Article number
Ø 125 x 22.2	2,000 – 5,000	7,600	30 m/sec	15	Special flexible plastic	Variable-speed angle grinders	5	80	96705

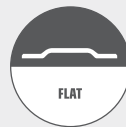

Suitable for

**ALL METALS**

# MAGNUM® Poly Magic Wheel

A revolution for mirror polishing in corners.



### How to use:

1. Pre-grind and level finer weld seams using the red MAGNUM® Poly Magic Wheel, A grit (80).
2. Polish to a flawless mirror finish using the grey MAGNUM® Poly Magic Wheel, B grit (900).

### FEATURES

- For fine grinding and polishing to a mirror finish in corners
- Saves a considerable amount of working time and replaces expensive manual labor, particularly in balustrade and hand-rail production where corner welds are often used
- Produces a flawless mirror finish in only two steps without the need for polishing pastes or creams
- With considerably more abrasive than conventional "unitized wheels and discs"
- Highly compressed fleece disc produced in an optimised production process using compressed individual flaps reinforced by foam impregnation
- Can be used on many variable-speed angle grinders, such as the VARILEX® WSF 1800
- Backing plate made from specially developed food-grade, flexible plastic: easy to trim and has a damping effect on vibration

### Technical Data:

Dimensions (mm)	Ideal speed (rpm)	Max. speed (rpm)	Approved for (DIN EN 13743)	Material thickness (mm)	Backing plate	Ideal for	Application	Pkg. unit	Grit (K)	Article number
Ø 165 x 22.2	3,000 – 4,000	5,700	30 m/sec	6	Special flexible plastic	Variable-speed angle grinders	Pre-Polishing (A)	5	80	96720
							Polishing (B)	5	900	96721

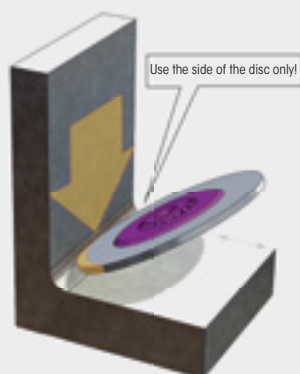

**NEW**

Suitable for

**ALL METALS**

## MAGNUM<sup>®</sup> Unitized

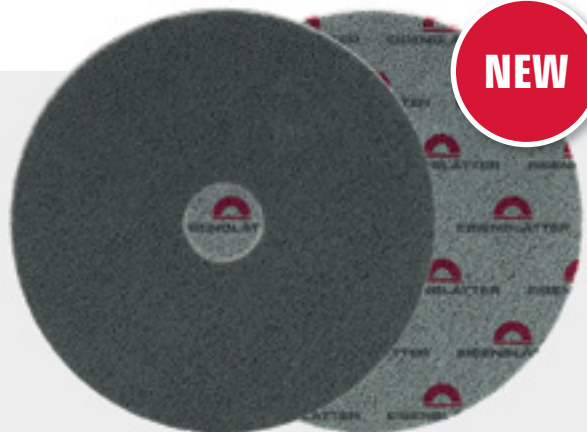

Comprises of compressed layers of fleece with a high grit content (grinds and polishes at the same time). For example, is ideal for fine grinding weld seams on pipes. Smooths and provides "soft" transitions. Removes minor scratches without damaging the workpiece (final grinding can be applied immediately using the MAGNUM<sup>®</sup> Poly Magic Wheel).

### FEATURES

- Particularly long service life
- High compressed nylon grit fleece
- Also effective at a lower range of speeds
- Only very fine traces of grinding and polishing remain
- Also removes metal, such as spot welds
- No discolouration remains

### Technical Data:

Dimensions (mm)	Max. speed (rpm)	Material thickness (mm)	Ideal for	Pkg. unit	Hardness	Result (Approx. grit)	Article number
Ø 127 x 22.2	10,000	3.2	Variable-speed angle grinders	10	Hard	180 – 220	96770
					Soft	240 – 280	96771
		6.3	Variable-speed angle grinders	10	Hard	180 – 220	96772
					Soft	240 – 280	96773
Ø 152 x 25.4	7,500	3.2	Fillet weld grinder	10	Hard	180 – 220	96775
					Soft	240 – 280	96776
		6.3	Fillet weld grinder	10	Hard	180 – 220	96777
					Soft	240 – 280	96778

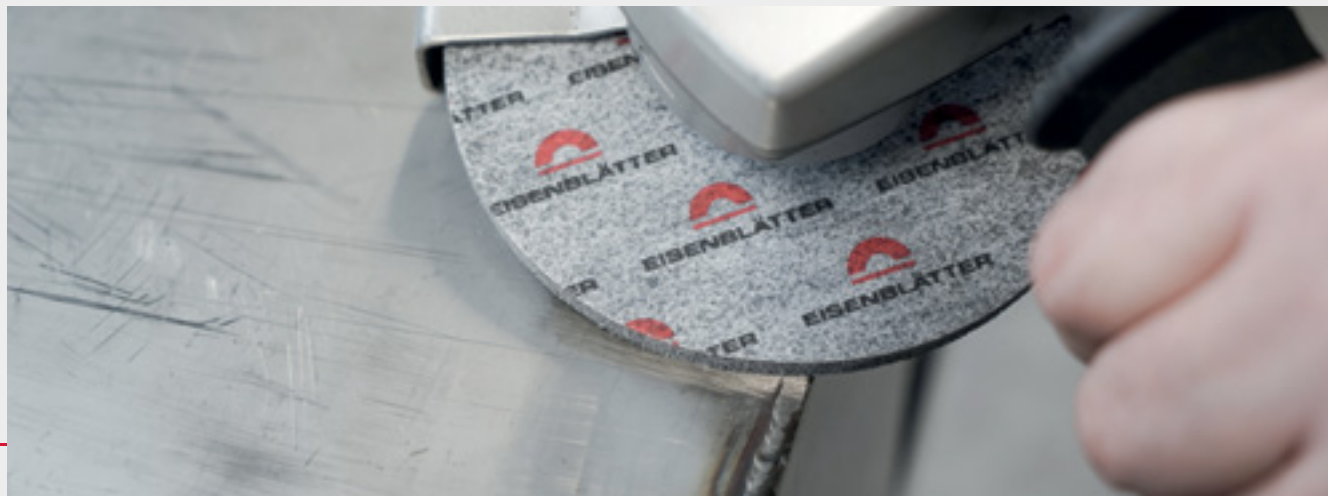



Suitable for

**STEEL · STAINLESS STEEL · NON-FERROUS METALS · WOOD · HARD PLASTICS**

## FIX SC Fleece Disc

Ideally suited for removing oxide layers, deburring and fine grinding.

**SEE PAGE 90 FOR MORE DETAILS.**

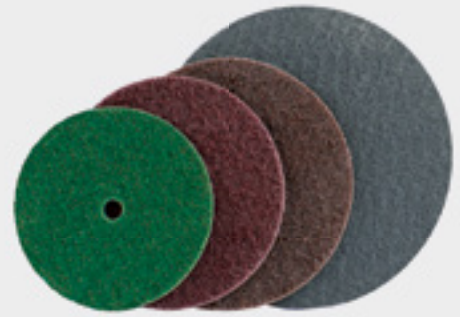

Suitable for

**STEEL · STAINLESS STEEL**

## FIX Trizact™ Disc

New type of abrasive fabric with pyramid-shaped grit structure. Saves on several working steps. Very fine result with a high rate of material removal.

**SEE PAGE 91 FOR MORE DETAILS.**



Suitable for

**ALUMINIUM · NON-FERROUS METALS**

## FIX AluPolish Disc

Soft nylon fleece material for fine grinding (pre-polishing) aluminium and soft metals for a perfect mirror finish.

**SEE PAGE 89 FOR MORE DETAILS.**



Suitable for

**STEEL · STAINLESS STEEL**

## MINI FIX Trizact™ Disc

New type of abrasive fabric with pyramid-shaped grit structure. Saves on several working steps. Very fine result with a high rate of material removal.

**SEE PAGE 96 FOR MORE DETAILS.**



Suitable for

**STEEL · STAINLESS STEEL · NON-FERROUS METALS · WOOD · HARD PLASTICS**

## MINI FIX SC Fleece Disc

Ideally suited for removing minor scratches and oxide layers, deburring and fine grinding.

**SEE PAGE 96 FOR MORE DETAILS.**



Suitable for

**ALL METALS**

## **FIX BRIGHTEX® Disc**

Polishing material that is already impregnated with BRIGHTEX® polishing paste removes the hassle and time-consuming business of applying pastes and creams and gives untreated material a shadow-free mirror finish.

**SEE PAGE 92 FOR MORE DETAILS.**



Suitable for

**ALL METALS**

## **FIX SuperPolish Disc**

Revolutionary special fleece. Used with polishing pastes and creams for a shiny mirror finish, particularly on stainless steel and non-ferrous metals which leaves no smears or shadows.

**SEE PAGE 93 FOR MORE DETAILS.**

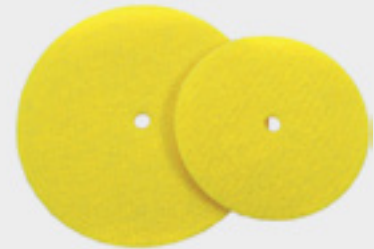

Suitable for

**ALL METALS · HARD PLASTICS**

## **FIX Felt Disc**

For a rapid mirror finish using polishing pastes and creams, leaving no scratches or smears.

**SEE PAGE 93 FOR MORE DETAILS.**



Suitable for

**ALL METALS**

## **MINI FIX BRIGHTEX® Disc**

Polishing material that is already impregnated with BRIGHTEX® polishing paste removes the hassle and time-consuming business of applying pastes and creams and gives untreated material a shadow-free mirror finish.

**SEE PAGE 97 FOR MORE DETAILS.**



Suitable for

**ALL METALS**

## **MINI FIX SuperPolish Disc**

Revolutionary special fleece. Used with polishing pastes and creams for a shiny mirror finish, particularly on stainless steel and non-ferrous metals which leaves no smears or shadows.

**SEE PAGE 98 FOR MORE DETAILS.**



Suitable for

**ALL METALS · HARD PLASTICS**

## **MINI FIX Felt Disc**

For a rapid mirror finish using polishing pastes and creams, leaving no scratches or smears.

**SEE PAGE 98 FOR MORE DETAILS.**



Suitable for

**ALL METALS**

# BRIGHTEX® Polishing Paste

Berry + Sun

For the first time, the pre-polish and main polishing steps can be completed using just one BRIGHTEX® paste (Berry)! This has been made possible by a completely new formulation and as a result, it only takes a few moments to polish stainless steel to a mirror finish. The yellow BRIGHTEX® Sun paste creates an even brighter high gloss shine – almost as if it's chrome plated. Both pastes can be used on SuperPolish & Felt discs, belts and sleeves. The process is to apply the paste onto the disc while running at a low speed ensuring it is completely covered. This process can be repeated several times. The pastes can also be used in addition to the new BRIGHTEX® polishing system (impregnated polishing discs, belts and sleeves) to "top up" the polishing paste as required.



## FEATURES

- For reconditioning surfaces that are mirror-polished mechanically
- For use with felt, cotton and fleece discs, wheels, sleeves, belts, etc.
- Ideal for use with polishing machines and hand-held polishing tools (POLY-PTX®)
- For best results, use Eisenblätter care and cleaning products for removing polish residues
- Completely new high-tech paste formulation for all metals

### BRIGHTEX® Berry:

- For applying a rapid high-gloss polish to all metals
- Pre-polish and main polish in one – save on additional operations

### BRIGHTEX® Sun:

- A mirror shine that's almost as if chrome-plated – the perfect finish
- For a final high gloss shine on polished metals
- For removing any leftover clouding and smears on all metals

## Technical Data:

Paste	Contents (g)	Application	Pkg. unit	Article number
BRIGHTEX® Berry pre-polishing paste	Approx. 1.100	Super polish	1	40025
BRIGHTEX® Sun final-polishing paste	Approx. 1.300	Top finish	1	40026



Suitable for

**ALL METALS**

# BRIGHTEX<sup>®</sup> Softclean Powder

A new and much improved cleaning powder removes all cream and paste residues after every polish and allows all metals to shine completely scratch-free in their best light. Replaces POLY Lime for a significantly better effect! Apply a little using the shaker and wipe off without applying any pressure using a clean microfibre cloth. Powder consists of ultra-fine micro-particles with a large surface area for the best possible absorbency.



**Technical Data:**

Packaging	Contents (g)	Pkg. unit	Article number
Resealable bag	Approx. 1,000	1	40028
Aluminium shaker	Approx. 200	1	40029

Suitable for

**ALL MATERIALS**

# BRIGHTEX<sup>®</sup> Non-Scratch Cloth



Much improved, ultra-soft microfibre cloth, free of seams for scratch-free cleaning of stainless steel surfaces and other decorative metals. Particularly soft and absorbent. Can be washed many times.

**Technical Data:**

Dimensions (mm)	Quality	Pkg. unit	Article number
400 x 400	360 g/m <sup>2</sup>	5	40031

Suitable for

**ALL METALS**

# Polishing Paste

Mirror finish polish for all metals (including aluminium).  
White for the pre polish and blue for the final polish.

**Technical Data:**

Paste	Packaging	Contents (g)	Pkg. unit	Article number
White pre-polishing paste	Cardboard sleeve	Approx. 650	1	40013
Blue final-polishing paste	Cardboard sleeve	Approx. 650	1	40014
Mini pastes – white and blue	ZIP-LOCK bags	Approx. 120 (60 each)	1	40009

Suitable for

**ALL METALS**

# Pink Polishing Cream

For the final polish. Produces a flawless mirror finish on all metals when applied to SuperPolish, felt and polishing rings. Brings a quick shine – also suitable for manual application using polishing cloths, which is perfect for unusual shaped objects.

**Technical Data:**

Packaging	Contents	Pkg. unit	Article number
Can	Approx. 1000 g	1	40015
Mini-tube	Approx. 60 ml	1	40015f



Suitable for

**ALL METALS**

# Microfibre Cloth

These microfibre cloths have a lightning-fast pore-deep cleaning effect and evenly distributes cleaning products onto the surface. It can also remove paste and cream residues.

**Technical Data:**

Dimensions (mm)	Quality	Pkg. unit	Article number
400 x 400	290 g/m <sup>2</sup>	25	40030

Suitable for

**ALL METALS · WOOD · BRICK**

## MAGNUM<sup>®</sup> Clean

The cleaning disc with a sand-blast like effect.



Cleans and removes pore-deep paint, rust, scale and dirt on all materials. Similar effect to sand-blasting; as it cleans without removing material. Ideal for car bodywork, the automotive industry, in shipyards and conservation work by commercial decorators and builders.

### FEATURES

- Pore-deep clean of metals and other materials
- Cleans without removing material from the workpiece and without damaging the basic material
- Does not smear, even when heavily soiled
- Particularly good at removing paint and lacquer coatings on wood, stone and metal, e.g. window frames, doors, furniture, cladding, railings, fences, machines, boat hulls, propellers, and for removing graffiti/impurities on concrete
- No metal content whatsoever and therefore no risk of corrosion
- The ideal cleaning disc for removing pore-deep paint, lacquer, rust, scale and oil smears
- Ideal for use in the car bodywork engineering (no straight-through grinding on thin sheet metals), in the automotive industry (underbody protection), for renovation jobs and commercial painting and building work
- Removes paint and fungal attacks on wood quickly and easily

### Technical Data:

Dimensions (mm)	Ideal speed (rpm)	Max. speed (rpm)	Material thickness (mm)	Backing plate	Ideal for	Pkg. unit	Article number
Ø 125 x 22.2	2,000 – 4,500	5,000	13	Special Plastic	Variable-speed angle grinders	5	96700

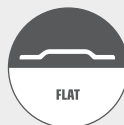



Suitable for

**ALL METALS · WOOD · BRICK**

### **CLEAN Disc MCD**

Cleans and removes pore-deep paint, rust, scale and dirt on all materials. Similar effect to sand-blasting; as it cleans without removing material. Ideal for car bodywork, the automotive industry, shipyards and renovation work by commercial decorators and builders. For example, can be used with drills.

**SEE PAGE 103 FOR MORE DETAILS.**

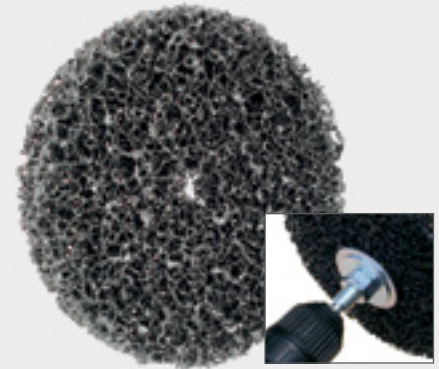

Suitable for

**ALL METALS · WOOD · BRICK**

### **FIX Clean Disc**

Cleans and removes pore-deep paint, rust, scale and dirt on all materials. Similar effect to sand-blasting; as it cleans without removing material. Ideal for car bodywork, the automotive industry, in shipyards and conservation work by commercial decorators and builders. With a hook & loop backing.

**SEE PAGE 88 FOR MORE DETAILS.**



Suitable for

**ALL METALS · WOOD · BRICK**

### **MINI FIX Clean Disc (flexible)**

Cleans and removes pore-deep paint, rust, scale and dirt on all materials. Similar effect to sand-blasting; as it cleans without removing material. Ideal for car bodywork, the automotive industry, in shipyards and conservation work by commercial decorators and builders. With a hook & loop backing.

**SEE PAGE 95 FOR MORE DETAILS.**



Suitable for

**COARSE-GRINDING TO POLISHING**

# VARILEX® WSF 1800



VARILEX® WSF 1800 – the strongest, variable-speed one-handed angle grinder in its class. Extremely strong and has infinitely adjustable speed.

### FEATURES

- Robust, extremely powerful motor with a rating of 1750 watts for demanding continuous operation under maximum load
- Extremely powerful one-handed angle grinder (for use with discs of up to 180 mm diameter)
- Infinitely adjustable speed from 2,000 rpm to 7,600 rpm with tachogenerator for constant speed even under load
- Outstanding for the cleaning, fine grinding and polishing of stainless steel and non-ferrous metals using the FIX HOOK & LOOP system and the MINI FIX HOOK & LOOP system with an adapter
- Balanced and vibration-damping handle reduces strain on the user
- Rubberised, ultra-ergonomic shaft handle makes for outstanding handling whilst working
- For use as a drive motor for flexible shafts (M14 thread)
- Ideal drive for high-performance discs such as TRIMFIX® HellFire®, TRIMFIX® BLACK MAMBA® and MAGNUM® Cool Top® 8 to exploit their full potential
- Ideal for working with flap discs, rough grinding and cutting discs



## Technical Data: VARILEX® WSF 1800 Machine

Plug type	Cable type	Mains connection (V ~ Hz)	Power (W)	Speed (rpm)	Mount	Weight (g)	Discs up to: (Ø mm)	Pkg. unit	Article number
EU (C+F)	QUICK-LOCK	220 – 240 ~ 50-60	1,750	2,000 – 7,600	M14 thread	2,800	180	1	65000
CH (J)	QUICK-LOCK	220 – 240 ~ 50-60	1,750	2,000 – 7,600	M14 thread	2,800	180	1	65000s
UK (G)	Permanent connection	110 ~ 50-60	1,600	2,000 – 7,600	M14 thread	2,800	180	1	65000a

Accessories included in package: 1 VARILEX® WSF 1800 machine, 1 x 4 m cable, 1 protection cover up to Ø 125 mm, 1 EASYLOCK clamping nut, 1 flap disc Ø 125 mm

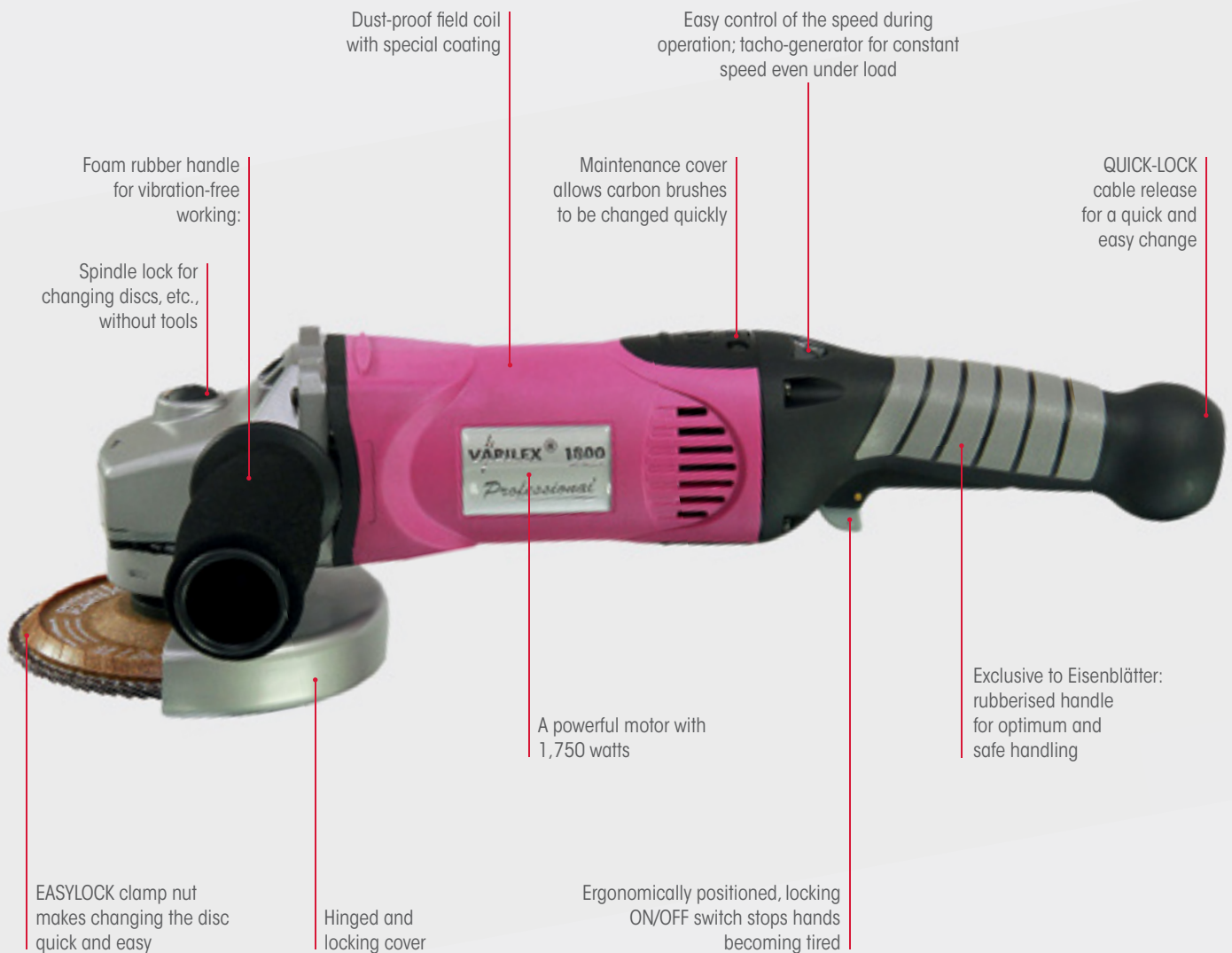

Dust-proof field coil with special coating

Easy control of the speed during operation; tacho-generator for constant speed even under load

Foam rubber handle for vibration-free working:

Maintenance cover allows carbon brushes to be changed quickly

QUICK-LOCK cable release for a quick and easy change

Spindle lock for changing discs, etc., without tools

Exclusive to Eisenblätter: rubberised handle for optimum and safe handling

A powerful motor with 1,750 watts

EASYLOCK clamp nut makes changing the disc quick and easy

Hinged and locking cover

Ergonomically positioned, locking ON/OFF switch stops hands becoming tired



Suitable for

**COARSE-GRINDING TO POLISHING**

# VARILEX® WSF 1800 Professional Set

In a practical carrying case

VARILEX® WSF 1800 set supplied in a case with a comprehensive range of accessories from coarse grinding to a flawless mirror finish.



**Technical Data:**

Plug type	Cable type	Mains connection (V ~ Hz)	Power (W)	Speed (rpm)	Mount	Pkg. unit	Article number
EU (C+F)	QUICK-LOCK	220 – 240 ~ 50-60	1,750	2,000 – 7,600	M14 thread	1	80050
CH (J)	QUICK-LOCK	220 – 240 ~ 50-60	1,750	2,000 – 7,600	M14 thread	1	80050s
UK (G)	Permanent connection	110 ~ 50-60	1,600	2,000 – 7,600	M14 thread	1	80050a

**Contents of Set:**

- 1 VARILEX® WSF 1800 machine
- 1 x 4 m cable
- 1 Protection cover for diameters up to Ø 125 mm
- 1 Cut-off wheel cover for diameters up to Ø 125 mm
- 1 Carry case
- 1 EASYLOCK clamping nut

**Coarse grinding:**

- 1 TRIMFIX® HellFire® Ø 125 mm
- 1 TWINFLEX® Ø 125 x 2.5 mm
- 1 RAZORCUT® cutting disc Ø 125 x 1.0 mm
- 1 Adhesive backing plate Ø 110 mm
- 1 FIX Cool Top® flap disc Ø 115 mm
- 2 FIX SC fleece discs Ø 115 mm
- 1 FIX Clean Ø 115 mm
- 1 FIX Fleece Top Ø 115 mm

**Polishing:**

- 1 Soft damping adapter Ø 110 mm
- 3 FIX Trizact™ discs Ø 115 mm
- 3 FIX SuperPolish discs Ø 115 mm
- 1 Mini-tube of polishing cream
- 2 Microfibre cloths
- 2 Mini polishing pastes (white and blue)
- 1 Shaker BRIGHTEX® Softclean powder



### QUICK-LOCK Cable

Suitable for VARILEX® WSF 900, 1600 & 1800, POLY-PTX® 300, 500 & 800 PROFESSIONAL, ROLEI EF 115, PIPE MAX, PIPE SNIPER® and GLADIUS® 1800.

#### Technical Data:

Version	Cable length (m)	Voltage (V)	Pkg. unit	Article number
EU (C+F)	4	220 – 240	1	52004-3
EU (C+F)	10	220 – 240	1	52005-3
CH (J)	4	220 – 240	1	52004-3s
AU	4	220 – 240	1	52004-3a
UK (G)	4	110	1	52004-3e
US (B)	4	120	1	52004-3u
Plug adapter – EU to UK	4		1	52004d



Suitable for

**VARILEX® WSF 1800**

### Special Protective Cover

For cutting and grinding discs.

The locking mechanism makes the cover easy to change.

#### Technical Data:

For discs up to (Ø mm)	Pkg. unit (Grinding disc cover)	Article number (Grinding disc cover)	Pkg. unit (Cutting disc cover)	Article number (Cutting disc cover)
125	1	65020	1	65023
150	1	65021		
180	1	65022	1	65025



### Machine Holder

Practical steel clamp and machine holder – supplied with powder-coated clamp bolt and is used with the VARILEX® WSF 1800. Used for securely fastening the unit to a workbench, for example to be used as a free-standing grinder. The holder can be inserted into a vice or suspended from a hook (for e.g. on the ceiling). Ideal for two-handed jobs and for use with a flexible shaft.

**Technical Data:**

Description of article	Material	Pkg. unit	Article number
Steel clamp and machine holder	Steel, powder-coated	1	10008



## Flexible Shaft

The new flexible shaft, with a sturdy 7 mm core and M14 thread can be upgraded to a professional drive motor. The VARILEX® WSF 1800 provides you with a powerful professional motor for all applications. Ideal for 6 mm shaft tools and, with an adapter, for polishing rings up to Ø 150 mm. Can also be used with the MULTI MAX® stationary machine.

**Technical Data:**

Length (mm)	Collet (mm)	Mount	Max. speed (rpm)	Can be used with (Ø mm)	Can be used with adapter (diameter of polishing rings in mm)	Pkg. unit	Article number
1,420	Ø 6	M14 thread	12,000	Up to 60	Up to 150	1	10014





WORK IT OUT FOR YOURSELF

# Huge Potential Savings

Sample calculation for flap discs

## Steel removed in 15 mins (steel/ST37)

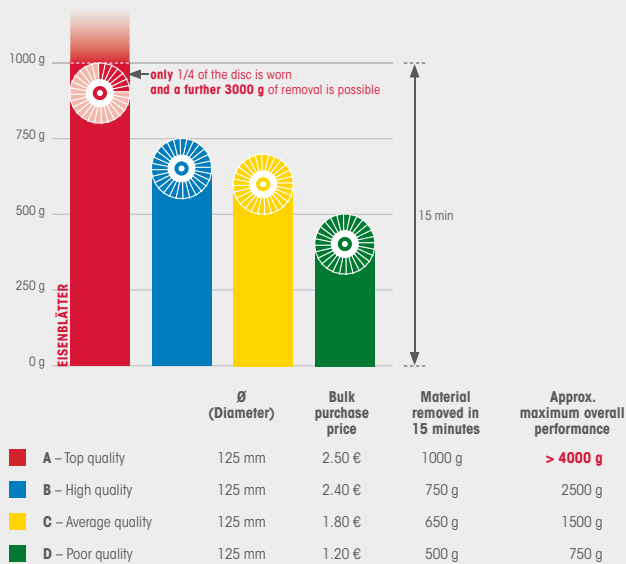

## Maximum material removal performance of one disc

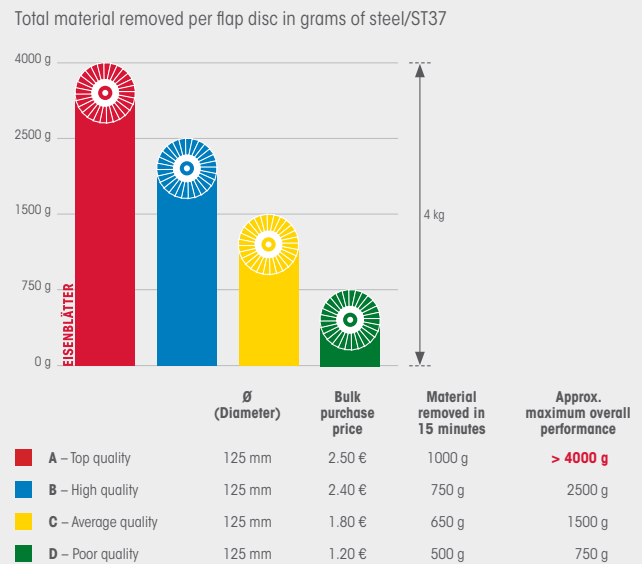

## Costs per 1 kg steel removal

Steel/ST37 DIN EN 10025-2 (worktime + tool costs)

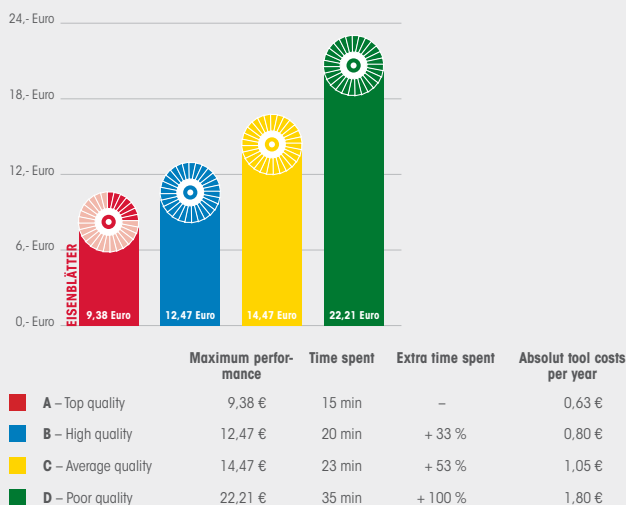

## Costs per worker per year

Including tool cost per annum

Calculation parameters: **8 hours a day multiplied by 300 work days = 2,400 hours per year**  
 Reference: **35 € per hour**  
 Reference: **disc type A** (in consideration of time spent working, grinding, tool costs)

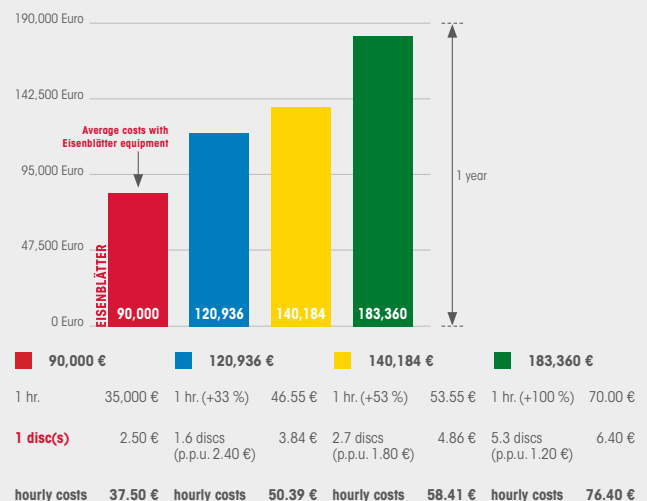

This model calculation and the test results are determined in manual testing on grinding robots in our own laboratory. Slight deviations caused by different machines and grinding methods are possible. The test results were determined using a VARILEX® angle grinder delivering 1,750 watts at approx. 7,600 rpm.

Suitable for

**CIRCULAR GRINDING · LINEAR GRINDING · PIPE GRINDING**

## VARILEX® WSF 900 DUO

The Swiss army knife of angle grinders.  
Linear grinder, pipe grinder, stationary grinder  
and angle grinder in one!



### FEATURES

- A mini workshop for all trade professionals, on site or for working on vehicles – perfect to always have with you!
- Compact angle grinder with high torque for flap discs up to Ø 115 mm, the FIX HOOK & LOOP system up to Ø 115 mm and with an adapter for the MINI FIX HOOK & LOOP system
- The practical, small power pack provides incredible versatility for very little weight
- Linear grinding machine with the easy-to-attach VARILEX® DUO grinding wheel mount for 50 mm wide wheels
- The new specially developed gearbox with reduced speed and high torque turns the machine into a real multi-tasker
- With grinding belt roller for grinding and polishing pipes (for example, open and close pipe constructions)
- Can also be used as a pipe cutter with the MAGNUM® RAZORCUT® or the MAGNUM® FINECUT PLUS which are just 1 mm thick



## Technical Data: VARILEX® WSF 900 DUO Machine

Plug type	Cable type	Mains connection (V ~ Hz)	Power (W)	Speed (rpm)	Mount	Weight (g)	Discs up to: (Ø mm)	Pkg. unit	Article number
EU (C+F)	QUICK-LOCK	220 – 240 ~ 50-60	850	2,000 – 5,000	M14 thread	2,100	115	1	65202

Accessories included in package: 1 VARILEX® WSF 900 DUO machine 850 watts, 1 x 4 m QUICK-LOCK cable, 1 protective cover for diameters up to 115 mm, 1 EASYLOCK clamping nut, 1 flap disc Ø 115 mm

Infinite speed control from 2,000 rpm to 5,000 rpm. Easy to control speed when operating; tacho-generator for constant speed even under load

The protective cover for linear grinding is simply attached and screwed to the angle grinder.

EASYLOCK clamping nut makes changing the disc quick and simple

1 tool – 4 functions – only 2.1 kg!  
Linear grinder, pipe grinder, stationary grinder and angle grinder in one!  
And converts super-fast!

QUICK-LOCK cable release for a quick and easy change

By simply attaching the Eco Smart mount, it's also possible to use 50 mm wide POLY-PTX® and Eco Smart grinding wheels.

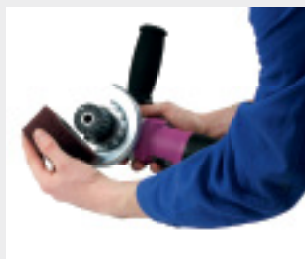



Suitable for

**CIRCULAR GRINDING · LINEAR GRINDING · PIPE GRINDING**

# VARILEX® WSF 900 DUO Professional Set



In a practical carrying case

VARILEX® WSF 900 Duo supplied in a carry case with a comprehensive range of accessories for levelling weld seams or producing a satin finish through to a mirror finish on surfaces and pipes. Also includes polishing pastes and care products.

**Technical Data:**

Plug type	Cable type	Mains connection (V ~ Hz)	Power (W)	Speed (rpm)	Mount	Discs up to: (Ø mm)	Pkg. unit	Article number
EU (C+F)	QUICK-LOCK	220 – 240 ~ 50-60	850	2,000 – 5,000	M14 thread	115	1	65203

**Contents of Set:**

- 1 VARILEX® WSF 900 DUO machine
- 1 Carry case
- 1 x 4 m QUICK-LOCK cable
- 1 Protective cover for diameters of up to 115 mm
- 1 EASYLOCK clamping nut
- 1 Adhesive backing plate Ø 115 mm
- 2 Mini polishing pastes (white and blue)
- 1 Microfibre cloth
- 1 Brilliance Clean 50 ml
- 1 INOX PROTECT 50 ml

**Linear grinding:**

- 1 Satin finisher cover incl. knurled screws
- 1 Expansion roller M14 Ø 90 x 50 mm
- 3 Trizact™ sleeves Ø 90 x 50 mm
- 3 SC fleece sleeves Ø 90 x 50 mm
- 2 Zirconium sleeves Ø 90 x 50 mm
- 2 SuperPolish sleeves Ø 90 x 50 mm

**Pipe grinding:**

- 1 Grinding belt roller M14 Ø 85 x 70 mm
- 1 SC fleece belt Ø 30 x 660 mm
- 1 Grinding belt 30 x 600 mm



### QUICK-LOCK Cable

Suitable for VARILEX® WSF 900, 1600 & 1800, POLY-PTX® 300, 500 & 800 PROFESSIONAL, ROLEI EF 115, PIPE MAX, PIPE SNIPER® and GLADIUS® 1800.

#### Technical Data:

Version	Cable length (m)	Voltage (V)	Pkg. unit	Article number
EU (C+F)	4	220 – 240	1	52004-3
EU (C+F)	10	220 – 240	1	52005-3
CH (J)	4	220 – 240	1	52004-3s
AU	4	220 – 240	1	52004-3a
UK (G)	4	110	1	52004-3e
US (B)	4	120	1	52004-3u
Plug adapter – EU to UK	4		1	52004d



### Machine Holder

Practical machine holder with clamp to fasten the tool securely. The holder can be placed in a vice or suspended from a hook (e.g. from the ceiling). Ideal for two-handed jobs.

#### Technical Data:

Description of article	Material	Pkg. unit	Article number
Clamp and suspended holder incl. clamp bolt	Steel, powder-coated	1	10009



Suitable for

**SLEEVES Ø 90 x 50 mm**

## VARILEX® DUO Expansion Roller

**Highly flexible.** For use when grinding, Trizact™, BRIGHTEX®, SC fleece and SuperPolish sleeves 50 mm wide on the VARILEX® WSF 900 DUO.

**FOR SUITABLE SLEEVES, SEE THE LINEAR GRINDING – SATIN FINISH SECTION FROM PAGE 114 ONWARDS.**



### Technical Data:

Dimensions (mm)	Mount	Max. speed (rpm)	Pkg. unit	Article number
Ø 90 x 50	M14 thread	6,000	1	65210



Suitable for

**BELTS UP TO 30 mm WIDE**

## VARILEX® WSF 900 DUO Grinding Belt Roller

**Guide roller with stainless steel flanges.** For using grinding belts for machining open and closed pipe constructions. Wear-resistant vulcan with flanges made of stainless steel, optimized shore-hardness and vibration-damping core.

**FOR SUITABLE BELTS, SEE THE LINEAR GRINDING – SATIN FINISH SECTION FROM PAGE 114 ONWARDS.**

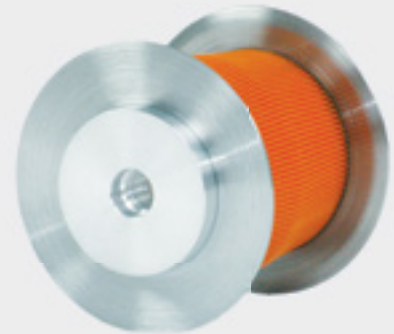

### Technical Data:

Dimensions (mm)	Mount	Max. speed (rpm)	Pkg. unit	Article number
Ø 85 x 70	M14 thread	6,500	1	65215



Suitable for

**GRINDING BELTS - TRIZACT™ - 30 X 600 MM**

## POLY-PTX® Special Adhesive Tape

Heat-resistant adhesive tape with longitudinal reinforcement for a tear-resistant hold on open and resealed grinding belts. Used to reseat high quality corundum and Trizact™ belts for use on closed pipe systems with a grinding belt roller. Perfect for extended pipe use with POLY-PTX® 800 and VARILEX® WSF 900 DUO.



**SEE PAGE 151 FOR MORE DETAILS.**



Suitable for

**WHEELS 50 mm WIDE**

### VARILEX® WSF 900 DUO Grinding Wheel Mount with 19 mm Keyway Shaft

This adapter turns the VARILEX® DUO angle grinder into a fully-fledged linear grinder using 50 mm width grinding rollers of the POLY-PTX® and Eco Smart system. Supplied with clamp bolts.

**FOR SUITABLE WHEELS, SEE THE LINEAR GRINDING – SATIN FINISH SECTION FROM PAGE 114 ONWARDS.**



#### Technical Data:

Dimensions (mm)	Mount	Max. speed (rpm)	Pkg. unit	Article number
Ø 45 x 50	M14 thread	6,000	1	65220



Suitable for

**LINEAR GRINDING**

### VARILEX® WSF 900 DUO Protective Cover

Protective cover for linear grinding jobs with the VARILEX® WSF 900 DUO. Supplied with knurled screws.



#### Technical Data:

Material	Pkg. unit	Article number
Stainless steel	1	65206



Suitable for

**VARILEX® WSF 900 DUO**

### Special Protective Cover

Specially developed protective cover with locking mechanism for using with grinding and cutting discs.



#### Technical Data:

For discs up to (Ø mm)	Pkg. unit (Grinding disc Cover)	Article number (Grinding disc cover)	Pkg. unit (Cutting disc cover)	Article number (Cutting disc cover)
115	1	65205	–	–
125	1	65209	1	65204



Suitable for

**FLAP DISCS · FIBRE DISCS · CUTTING DISCS**

# VARILEX<sup>®</sup> WSF 905 PROFESSIONAL



Professional, compact, variable-speed, one-handed angle grinder for universal application.

### FEATURES

- Easy to use one-handed angle grinder with effective capacity for flap discs up to  $\varnothing$  125 mm. Guaranteed to reduce the strain on the user
- Compact all-rounder you can keep with you. Ideal for use on assembly or on site
- Optimised speeds for a wide range of tools
- Top quality tool in a compact design and low noise emission
- Infinite speed control from 2,000 rpm to 8,000 rpm
- Clever automatic shut-down: prevents overloads and returns back to power



### Technical Data: VARILEX® WSF 905 PROFESSIONAL Machine

Plug type	Cable type	Mains connection (V ~ Hz)	Power (W)	Speed (rpm)	Weight (g)	Mount	Discs up to: (Ø mm)	Pkg. unit	Article number
EU (C+F)	Permanent connection	220 – 240 – 50-60	850	2,000 – 8,000	2,100	M14 thread	125	1	65501

Accessories included in package: 1 VARILEX® WSF 905 PROFESSIONAL machine 850 watts, 1 x 4 m cable, 1 protective cover for up to Ø 125 mm, 1 EASYLOCK clamping nut, 1 flap disc Ø 125 mm



Hinged and locking cover

Spindle lock is easy to operate

850-watt power rating. High torque due to transmission ratio

Infinite speed control from 2000 rpm to 8000 rpm. Easy to control speed when operating; tacho-generator for constant speed even under load.

EASYLOCK clamping nut makes changing the disc a simple and quick operation

Light-weight motor reduces strain on the user



# VARILEX® WSF 905 Metal Set

in a practical carry case



The ideal one-handed angle grinder for use with flap discs, cutting discs, cleaning discs and fine grinding supplied in a case as a set.

### Technical Data:

Plug type	Cable type	Mains connection (V ~ Hz)	Power (W)	Speed (rpm)	Mount	Discs up to: (Ø mm)	Pkg. unit	Article number
EU (C+F)	Permanent connection	220 – 240 ~ 50-60	850	2,000 – 8,000	M14 thread	125	1	65502

### Contents of Set:

- 1 VARILEX® WSF 905 machine
- 1 EASYLOCK clamping nut
- 1 Protective cover for diameters of up to 125 mm
- 1 Carry case
- 3 TRIMFIX® HellFire® Ø 125 mm
- 10 MAGNUM® TWINFLEX® Ø 125 mm
- 1 MAGNUM® Fleece Top Ø 115 mm
- 3 TRIMFIX® Fleece Flap Ø 125 mm
- 2 TRIMFIX® ZIRCOPUR® Ø 125 mm
- 1 MAGNUM® Clean Ø 125 mm



Suitable for

**VARILEX® WSF 905 PROFESSIONAL**

### Special Protective Cover

Specially developed protective cover with bayonet lock for use with grinding or cutting discs.



#### Technical Data:

Dimensions (mm)	Pkg. unit (Grinding disc cover)	Article number (Grinding disc cover)	Pkg. unit (Cutting disc cover)	Article number (Cutting disc cover)
Ø 115	1	65205	-	-
Ø 125	1	65209	1	65204





**FIX HOOK  
& LOOP in  
3 seconds!**





# MULTIFUNCTIONAL GRINDING

## HOOK & LOOP COMPLETE SYSTEM ..... 86

<b>FIX</b> .....	<b>86</b>
FIX Special Backing Pad .....	86
FIX Cool Top® .....	87
FIX HellFire® .....	87
FIX Flexible Zirconium Disc .....	88
FIX Clean Disc .....	88
FIX Fleece Top Disc .....	89
FIX AluPolish .....	89
FIX SC Fleece .....	90
FIX Trizact™ Disc .....	91
FIX BRIGHTEX® Disc .....	92
FIX SuperPolish Disc .....	93
FIX Felt Disc .....	93
<b>MINI FIX</b> .....	<b>94</b>
MINI FIX Backing Pad .....	94
MINI FIX Cool Top® Flap Disc .....	95
MINI FIX Clean Disc .....	95
MINI FIX SC Fleece Disc .....	96
MINI FIX Trizact™ Disc .....	96
MINI FIX BRIGHTEX® Disc .....	97
MINI FIX SuperPolish Disc .....	98
MINI FIX Felt Disc .....	98

## GRINDING AND BLENDING ..... 99

MINI MAX® Zirconium Sleeve .....	99
MINI MAX® Flap Wheel .....	100

## FINISHING AND FINE GRINDING ..... 101

MINI MAX® Mix Wheel .....	101
MINI MAX® Fleece Wheel .....	101

## POLISHING ..... 102

MINI MAX® Felt Polishing Tip .....	102
MINI MAX® Clamping Shaft .....	102

## CLEANING ..... 103

CLEAN Disc MCD .....	103
----------------------	-----

## TECHNICAL BRUSHES ..... 104

MINI MAX® Stainless Steel Wire Wheel .....	104
MINI MAX® Stainless Steel Wire Brush .....	104
MINI MAX® Clamping Spindle .....	105

## POWER TOOLS ..... 106

MINI MAX® PRO .....	106
MINI MAX® PRO Professional Set .....	108
Flexible Shaft .....	109
Machine Holder .....	109

## STATIONARY MACHINES ..... 110

MULTI MAX® .....	110
MULTI MAX® Professional Set .....	112
Flexible Shaft .....	113
MULTI MAX® Machine Stand .....	113

# HOOK & LOOP COMPLETE SYSTEM

FIX

Suitable for

**FIX HOOK & LOOP TOOLS**

## FIX Special Backing Pad



Specially designed pad made from flexible polyurethane with a click system, stabilising fins and centring pin to ensure the disc runs perfectly.

**Optional:** Flexible, 6 mm thick damping adapter with hook & loop fastening and a specially designed damping layer. The centring pin is visible to allow the disc to be precisely centred.

### Technical Data:

Article	Dimensions (mm)	Max. speed (rpm)	Mount	Material thickness (mm)	Material	Hook & Loop	Pkg. unit	Article number
FIX special backing pad	Ø 96 x 10	11,000	M14 thread		Polyurethane	Mushroom-shaped head	1	80100p
	Ø 110 x 10	10,500	M14 thread		Polyurethane	Mushroom-shaped head	1	80115p
	Ø 119 x 10	10,100	M14 thread		Polyurethane	Mushroom-shaped head	1	80123p
	Ø 143 x 10	8,500	M14 thread		Polyurethane	Mushroom-shaped head	1	80150p
	Ø 168 x 10	7,200	M14 thread		Polyurethane	Mushroom-shaped head	1	80160p
Soft damping adapter	Ø 110 x 10	10,500	Hook & loop	6	Foam	Harpoon hook & loop	5	80120
	Ø 143 x 10	8,500	Hook & loop	6	Foam	Harpoon hook & loop	5	80155

### Which pad is used with which tool?

#### FIX Backing Pad with mushroom shaped head



HellFire®	Cool Top®	Zirconium disc	Clean	Fleece Top	Felt disc	SuperPolish	BRIGHTEX®

#### FIX Soft Damping Layer with harpoon hook & loop



SC Fleece	AluPolish	Zirconium disc	Trizact™	Felt disc	SuperPolish	BRIGHTEX®



Suitable for

**STEEL · STAINLESS STEEL · NON-FERROUS METALS**

## FIX Cool Top®

With Cool Top® pure zirconium abrasive. Superb material removal performance, extremely long service life with uniformly clean results and no discolouration of the material or smearing. Highly flexible – adjusts to workpieces of any shape to produce an unbeatable finish.

### Technical Data:

Dimensions (mm)	Ideal speed (rpm)	Max. speed (rpm)	Approved for (DIN EN 13743)	Backing	Pkg. unit	Grit (K)	Article number
Ø 115 x 10	7,000 – 9,000	10,500	63 m/sec	Hook & loop	25	40	80340
						60	80360
						80	80380
						120	80390
Ø 125 x 10	6,000 – 8,000	9,600	63 m/sec	Hook & loop	25	40	80440
						60	80460
						80	80480
						120	80490
Ø 150 x 10	6,000 – 7,000	8,000	63 m/sec	Hook & loop	25	40	80540
						60	80560
						80	80580
						120	80590

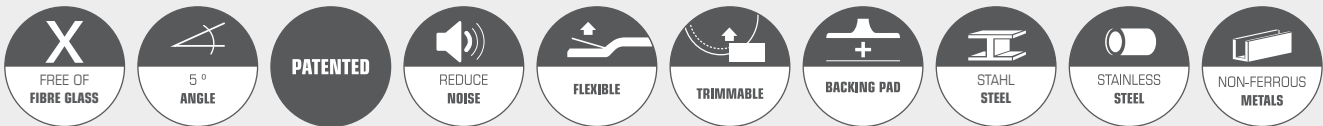

Suitable for

**ALL METALS**

## FIX HellFire®

With a new type of highly aggressive ceramic-hybrid abrasive cloth: saves a considerable amount of time, prevents heat deformation, discolouration and provides 40 grit grinding with 60 grit results. Adjusts easily to workpieces of any shape – delivers best grinding results due to high degree of elasticity. New flap arrangement guarantees maximum material removal.

### Technical Data:

Dimensions (mm)	Ideal speed (rpm)	Max. speed (rpm)	Approved for (DIN EN 13743)	Backing	Pkg. unit	Grit (K)	Article number
Ø 125 x 10	5,000 – 8,000	9,600	63 m/sec	Hook & loop	25	Multigrain 40/60	80222
Ø 150 x 10	5,000 – 8,000	8,000	63 m/sec	Hook & loop	25	Multigrain 40/60	80225





# HOOK & LOOP COMPLETE SYSTEM

FIX

Suitable for

**STEEL · STAINLESS STEEL**

## FIX Flexible Zirconium Disc



Zirconium fibre disc with outstanding results for coarse grinding and for pre-grinding. Levels weld seams, removes scratches. Ideal for car bodywork and in motor vehicle workshops.

### Technical Data:

Dimensions (mm)	Ideal speed (rpm)	Max. speed (rpm)	Approved for (DIN EN 13743)	Backing	Pkg. unit	Grit (K)	Article number
Ø 115 x 10	5,000 – 10,000	10,500	63 m/sec	Hook & loop	50	40	80904
						60	80906
						80	80908
						120	80909
Ø 150 x 10	4,000 – 8,000	8,000	63 m/sec	Hook & loop	50	40	80914
						60	80916
						80	80918
						120	80919



Suitable for

**ALL METALS · WOOD · BRICK**

## FIX Clean Disc



Cleans and removes pore-deep paint, rust, scale and dirt on all materials. Similar effect to sand-blasting; as it cleans without removing material. Ideal for car bodywork, the automotive industry, shipyards and renovation work by commercial decorators and builders.

### Technical Data:

Dimensions (mm)	Ideal speed (rpm)	Max. speed (rpm)	Material thickness (mm)	Backing	Pkg. unit	Article number
Ø 115 x 10	2,000 – 4,500	5,000	13	Hook & loop	5	80901
Ø 150 x 10	2,000 – 4,000	5,000	13	Hook & loop	5	80900



Suitable for

**ALL METALS · WOOD · HARD PLASTICS**

## FIX Fleece Top Disc



For metalworking jobs such as grinding, fine grinding, polishing and for removing scale, oxides, scratches, rust, burrs and paint. Also cleans and smooths wood and plastics. **FOR MORE INFORMATION AND ROUGHNESS DATA, SEE PAGE 57.**

### Technical Data:

Dimensions (mm)	Ideal speed (rpm)	Max. speed (rpm)	Material thickness (mm)	Backing	Pkg. unit	Grit (K)	Article number
Ø 115 x 10	2,000 – 5,000	8,000	15	Hook & loop	5	80	80810
						180	80811
						280	80812
						400	80813
						600	80814
						900	80815

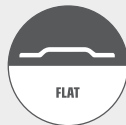

Suitable for

**ALUMINIUM · NON-FERROUS METALS**

## FIX AluPolish



Soft nylon fleece material for fine grinding (pre-polishing) aluminium and soft metals for a perfect mirror finish.

### Technical Data:

Dimensions (mm)	Ideal speed (rpm)	Max. speed (rpm)	Backing	Pkg. unit	Grit (Fleece)	Article number
Ø 115 x 10	2,000 – 3,000	4,000	Hook & loop	10	Superfine	80680
Ø 150 x 10	2,000 – 3,000	3,000	Hook & loop	10	Superfine	80690



# HOOK & LOOP COMPLETE SYSTEM

FIX

Suitable for

**STEEL · STAINLESS STEEL · NON-FERROUS METALS · WOOD · HARD PLASTICS**

## FIX SC Fleece



Technical surface conditioning fleece – ideally suited for removing oxide layers, deburring and fine grinding. The newly developed 1FOR2 SC fleece fabric (green) allows weld seams and spot welds to be removed while also delivering a fine finish and clean, "soft" blending.

### Technical Data:

Dimensions (mm)	Ideal speed (rpm)	Max. speed (rpm)	Backing	Pkg. unit	Grit (K)	Colour (Fleece)	Grit (Fleece)	Article number
Ø 100 x 10	5,000 – 8,000	12,000	Hook & loop	20	80	Brown	Coarse	80605
					180	Red	Medium	80606
					280	Blue	Fine	80607
Ø 115 x 10	4,000 – 7,000	10,500	Hook & loop	10	40	Green	1FOR2 (extra coarse)	80613
				20	80	Brown	Coarse	80615
					180	Red	Medium	80616
					280	Blue	Fine	80617
					400	Grey	Superfine	80618
Ø 125 x 10	4,000 – 6,000	9,600	Hook & loop	10	40	Green	1FOR2 (extra coarse)	80624
				20	80	Brown	Coarse	80625
					180	Red	Medium	80626
					280	Blue	Fine	80627
Ø 150 x 10	3,000 – 5,000	8,000	Hook & loop	10	40	Green	1FOR2 (extra coarse)	80649
				20	80	Brown	Coarse	80650
					180	Red	Medium	80651
					280	Blue	Fine	80652
					400	Grey	Superfine	80653
Ø 178 x 10	2,000 – 4,000	6,700	Hook & loop	20	80	Brown	Coarse	80670
					180	Red	Medium	80671
					280	Blue	Fine	80672





Suitable for

**STEEL · STAINLESS STEEL**

## FIX Trizact™ Disc

New type of abrasive cloth with pyramid-shaped grit structure. Saves on several operating steps and has a high rate of material removal with a fine finish. Great for removing scratches and spot welds. Ideal for pre-polishing into subsequent mirror finish polishing. Leaves only minor surface roughness behind.

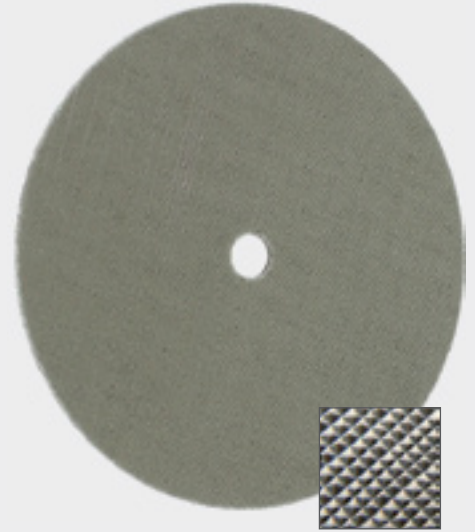

### Technical Data:

Dimensions (mm)	Ideal speed (rpm)	Max. speed (rpm)	Approved for (DIN EN 13743)	Backing	Pkg. unit	Grit (Trizact™)	Grit (K)	Material removal (Approx. grit)	Article number
Ø 115 x 10	4,000 – 6,000	10,500	63 m/sec	Hook & loop	10	A160	120	24	80930
						A100	220	36	80931
						A65	280	40	80932
						A45	400	50	80940
						A30	600	60	80960
						A16	1200	80	80970
						A06	2000	120	80980
Ø 150 x 10	3,000 – 5,000	8,000	63 m/sec	Hook & loop	10	A160	120	24	80983
						A100	220	36	80984
						A65	280	40	80985
						A45	400	50	80986
						A30	600	60	80987
						A16	1200	80	80988
						A06	2000	120	80989



# HOOK & LOOP COMPLETE SYSTEM

FIX



Suitable for

**ALL METALS**

## FIX BRIGHTEX<sup>®</sup> Disc



Polishing material that is already impregnated with BRIGHTEX<sup>®</sup> polishing paste removes the hassle and time-consuming business of applying pastes and creams to give untreated metal a shadow-free mirror finish.

### FEATURES

- For reconditioning surfaces which are mirror polished mechanically
- Ideal for use with polishing machines and hand-held polishing tools
- For best results, use Eisenblätter care and cleaning products for removing polish residues
- With centring hole for backing plates with centring pins
- Completely new high-tech paste formulation for all metals

#### BRIGHTEX<sup>®</sup> Berry:

- For applying a rapid high-gloss polish to all metals
- Pre-polish and main polish in one – save on additional operations
- For immediate use without the need for additional pastes and creams!

#### BRIGHTEX<sup>®</sup> Sun:

- A mirror shine that's almost as if chrome-plated – the perfect finish
- For a final high gloss shine on polished metals
- For removing any leftover clouding and smears on all metals

### Technical Data:

Version	Dimensions (mm)	Material thickness (mm)	Ideal speed (rpm)	Max. speed (rpm)	Backing	Application	Pkg. unit	Article number
Berry	Ø 115 x 10	5	2,500 – 3,500	10,500	Hook & loop	Super polish	10	80718
	Ø 125 x 10	5	2,000 – 3,000	9,600	Hook & loop	Super polish	10	80728
	Ø 150 x 10	5	2,000 – 2,500	8,000	Hook & loop	Super polish	10	80753
	Ø 178 x 10	5	2,000	6,700	Hook & loop	Super polish	10	80773
Sun	Ø 115 x 10	5	2,500 – 3,500	10,500	Hook & loop	Top finish	10	80719
	Ø 125 x 10	5	2,000 – 3,000	9,600	Hook & loop	Top finish	10	80729
	Ø 150 x 10	5	2,000 – 2,500	8,000	Hook & loop	Top finish	10	80754
	Ø 178 x 10	5	2,000	6,700	Hook & loop	Top finish	10	80774

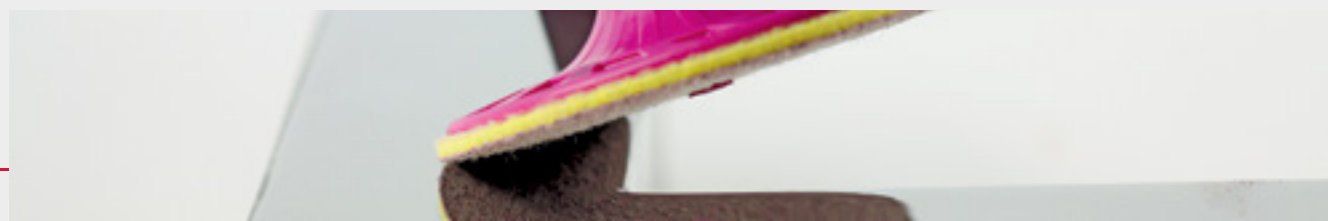

Suitable for

**ALL METALS**

## FIX SuperPolish Disc

Revolutionary special fleece. Used with polishing pastes and creams for a shiny mirror finish on stainless steel and non-ferrous metals which leaves no smears or shadows. Always use a separate SuperPolish disc for each paste and cream as it is important to not mix different grit sizes. **ONLY USE IN COMBINATION WITH A BACKING PAD (SEE PAGE 86) AND POLISHING PASTES (SEE PAGE 63) OR POLISHING CREAM (SEE PAGE 65).**



### Technical Data:

Dimensions (mm)	Ideal speed (rpm)	Max. speed (rpm)	Material thickness (mm)	Backing	Pkg. unit	Article number
Ø 115 x 10	3,000 – 6,000	10,500	5	Hook & loop	10	80715n
Ø 125 x 10	3,000 – 6,000	9,600	5	Hook & loop	10	80725n
Ø 150 x 10	2,000 – 5,000	8,000	5	Hook & loop	10	80750n
Ø 178 x 10	2,000 – 5,000	6,700	5	Hook & loop	10	80770n



Suitable for

**STAINLESS STEEL · NON-FERROUS METALS · HARD PLASTICS**

## FIX Felt Disc

First-rate merino felt for a rapid mirror finish using polishing pastes and creams and no scratches or smears. Always use a separate felt disc for each paste and cream as it is important to not mix different grits. **ONLY USE IN COMBINATION WITH A BACKING PAD (SEE PAGE 86) AND POLISHING PASTES (SEE PAGE 63) OR POLISHING CREAM (SEE PAGE 65).**

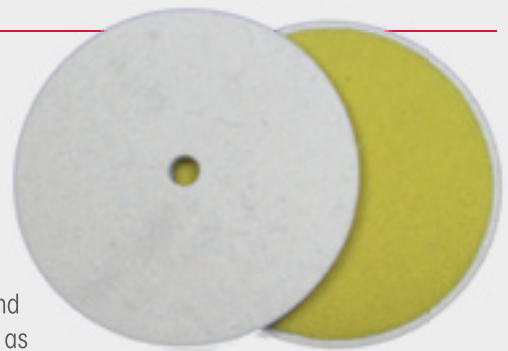

### Technical Data:

Dimensions (mm)	Ideal speed (rpm)	Max. speed (rpm)	Material thickness (mm)	Material	Backing	Pkg. unit	Article number
Ø 100 x 10	3,000 – 6,000	12,000	5	Merino felt	Hook & loop	10	80705
Ø 115 x 10	3,000 – 6,000	10,500	5	Merino felt	Hook & loop	10	80715
Ø 125 x 10	3,000 – 6,000	9,600	5	Merino felt	Hook & loop	10	80725
Ø 150 x 10	2,000 – 5,000	8,000	5	Merino felt	Hook & loop	10	80750
Ø 178 x 10	2,000 – 5,000	6,700	5	Merino felt	Hook & loop	10	80770





# HOOK & LOOP COMPLETE SYSTEM

MINI FIX

Suitable for

## MINI FIX TOOLS

# MINI FIX Special Backing Pad



Flexible backing pad made from wear-resistant polyurethane material with hook & loop fastening and centring pin to ensure disc runs perfectly and free of vibration. The ventilation slots provide for a lower temperature on top while grinding.

**Optional:** Flexible damping adapter with hook & loop fastening is highly recommended for polishing and fine grinding. The centring pin is visible to enable the disc to be precisely centred.

### Technical Data:

Article	Dimensions (mm)	Mount	Max. speed (rpm)	Material thickness (mm)	Material	Hook & loop	Pkg. unit	Article number
MINI FIX special backing pad	Ø 60 x 10	Diameter 6 mm steel shaft	20,000		Polyurethane	Mushroom-shaped head	1	10100
MINI FIX special backing pad	Ø 60 x 10	M14 thread	20,000		Polyurethane	Mushroom-shaped head	1	10100b
Soft damping adapter	Ø 60 x 10	Hook & loop	20,000	6	Foam	Harpoon hook & loop	5	10105

## Which backing pad is used with which tool?

### MINI FIX Backing Pad with mushroom head round plates



Cool Top®	Clean	Felt disc	SuperPolish	BRIGHTEX®

### MINI FIX Soft damping adapter with harpoon hook and loop



SC fleece	Trizact™	Felt disc	SuperPolish	BRIGHTEX®

Suitable for

**STEEL · STAINLESS STEEL**

# MINI FIX Cool Top® Flap Disc

Quick-change mini zirconium flap disc

Ultra-long service life, high rate of material removal, a uniform, clean result and no discolouration of the material and adjusts to the workpiece to best effect. On environmentally friendly fibre backing material.



### Technical Data:

Dimensions (mm)	Ideal speed (rpm)	Max. speed (rpm)	Pkg. unit	Grit (K)	Article number
Ø 63 x 10	6,000 – 10,000	19,000	20	40	10134
				60	10136
				80	10138
				120	10139



Suitable for

**ALL METALS · WOOD · BRICK**

# MINI FIX Clean Disc

Cleans and removes pore-deep paint, rust, scale and dirt on all materials.

Similar effect to sand-blasting; as it cleans without removing material.

Ideal for use in car bodywork, the automotive industry, shipyards and renovation work by commercial decorators and builders.



### Technical Data:

Dimensions (mm)	Ideal speed (rpm)	Max. speed (rpm)	Material thickness (mm)	Pkg. unit	Article number
Ø 63 x 10	6,000 – 8,000	12,000	13	20	10101



# HOOK & LOOP COMPLETE SYSTEM

MINI FIX

Suitable for

**STEEL · STAINLESS STEEL · NON-FERROUS METALS · WOOD · HARD PLASTICS**

## MINI FIX SC Fleece Disc

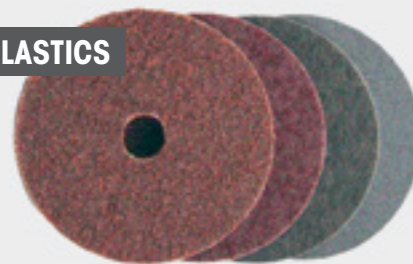

Technical surface conditioning fleece – ideally suited for: removing minor scratches, oxide layers, deburring and fine grinding on metals and other materials.

### Technical Data:

Dimensions (mm)	Ideal speed (rpm)	Max. speed (rpm)	Pkg. unit	Grit (K)	Colour (Fleece)	Grit (Fleece)	Article number
Ø 60 x 10	6,000 – 10,000	19,000	20	80	Brown	Coarse	10151
				180	Red	Medium	10152
				280	Blue	Fine	10153
				400	Grey	Superfine	10154



Suitable for

**STEEL · STAINLESS STEEL**

## MINI FIX Trizact™ Disc

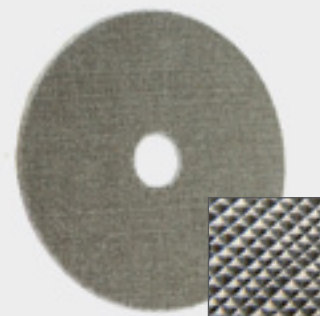

New type of abrasive cloth with pyramid-shaped grit structure. Saves on several operating steps and has a high rate of material removal with a fine finish. Great for removing scratches and spot welds. Ideal for pre-polishing into subsequent mirror finish polishing. Leaves only minor surface roughness behind.

### Technical Data:

Dimensions (mm)	Ideal speed (rpm)	Max. speed (rpm)	Pkg. unit	Grit (Trizact™)	Grit (K)	Removes material like (Approx. grit)	Article number
Ø 60 x 10	6,000 – 10,000	19,000	20	A100	220	36	10141
				A65	280	40	10142
				A45	400	50	10143
				A30	600	60	10144
				A16	1200	80	10145
				A06	2000	120	10146





Suitable for

**ALL METALS**

**NEW**

# MINI FIX BRIGHTEX® Disc



Polishing material that is already impregnated with BRIGHTEX® polishing paste removes the hassle and time-consuming business of applying pastes and creams and gives untreated metal a shadow-free mirror finish.

### FEATURES

- For reconditioning surfaces that are mirror-polished mechanically
- Ideal for use with polishing machines and hand-held polishing tools
- For best results, use Eisenblätter care and cleaning products for removing polish residues
- With centring hole for backing plates with centring pins
- Completely new high-tech paste formulation for all metals

#### BRIGHTEX® Berry:

- For applying a rapid high-gloss polish to all metals
- Pre-polish and main polish in one – saves additional working steps
- For immediate use without the need for additional pastes and creams!

#### BRIGHTEX® Sun:

- A mirror shine that's almost as if chrome-plated – the perfect finish
- For a final high gloss shine on polished metals
- For removing any leftover clouding and smears on all metals

### Technical Data:

Version	Dimensions (mm)	Material thickness (mm)	Ideal speed (rpm)	Max. speed (rpm)	Application	Pkg. unit	Article number
Berry	Ø 60 x 10	5	6,000 – 8,000	19,000	Super polish	20	10118
Sun	Ø 60 x 10	5	6,000 – 8,000	19,000	Top finish	20	10119

PATENT PENDING

FLEXIBLE

BACKING PAD

ALL METALS



# HOOK & LOOP COMPLETE SYSTEM

MINI FIX

Suitable for

**ALL METALS**

## MINI FIX SuperPolish Disc



Revolutionary special fleece. Used with polishing pastes and creams for a shiny mirror finish on stainless steel and non-ferrous metals which leaves no smears or shadows. Always use a separate SuperPolish disc for each paste and cream as it is important to not mix different grit sizes.

**ONLY IN COMBINATION WITH A BACKING PAD (SEE PAGE 94) AND POLISHING PASTES (SEE PAGE 63) OR POLISHING CREAM( SEE PAGE 65).**

### Technical Data:

Dimensions (mm)	Ideal speed (rpm)	Max. speed (rpm)	Material thickness (mm)	Pkg. unit	Article number
Ø 60 x 10	6,000 – 8,000	19,000	5	20	10117n



Suitable for

**STAINLESS STEEL · NON-FERROUS METALS · HARD PLASTICS**

## MINI FIX Felt Disc



First-rate merino felt for a rapid mirror finish using polishing pastes and creams and no scratches or smears.

Always use a separate felt disc for each paste and cream as it is important to not mix different grit sizes.

**ONLY IN COMBINATION WITH A BACKING PAD (SEE PAGE 94) AND POLISHING PASTES (SEE PAGE 63) OR POLISHING CREAM( SEE PAGE 65).**

### Technical Data:

Dimensions (mm)	Ideal speed (rpm)	Max. speed (rpm)	Material thickness (mm)	Material	Pkg. unit	Article number
Ø 60 x 10	6,000 – 8,000	19,000	5	Merino felt	20	10117



Suitable for

**STEEL · STAINLESS STEEL · NON-FERROUS METALS**

# MINI MAX<sup>®</sup> Zirconium Sleeve



For removing spot welds, heavy burrs, deep scratches, etc.

**Technical Data:**

Dimensions (mm)	Max. speed (rpm)	Pkg. unit	Grit (K)	Article number
Ø 30 x 30	12,000	50	40	10214
			60	10216
			80	10218
Ø 45 x 30	12,000	50	40	10224
			60	10226
			80	10228

## MINI MAX<sup>®</sup> Expansion Roller

Expanding rubber roller for safely mounting MINI MAX<sup>®</sup> zirconium sleeves.**Technical Data:**

Dimensions (mm)	Mount	Max. speed (rpm)	Pkg. unit	Article number
Ø 30 x 30	6 mm steel shaft	12,000	1	10201
Ø 45 x 30		12,000	1	10202





Suitable for

**ALL METALS · WOOD · HARD PLASTICS**

## MINI MAX<sup>®</sup> Flap Wheel



For cleaning, removing rust and scratches and linear grinding.

### Technical Data:

Dimensions (mm)	Mount	Speed (rpm)	Material	Pkg. unit	Grit (K)	Article number
Ø 40 x 10	6 mm steel shaft	max. 12,000	High quality corundum	10	40	11040
					60	11060
					80	11080
					100	11100
Ø 60 x 30	6 mm steel shaft	max. 12,000	High quality corundum	10	40	11041
					60	11061
					80	11081
					100	11101



Suitable for

**STEEL · STAINLESS STEEL · NON-FERROUS METALS · WOOD · HARD PLASTICS**

## MINI MAX<sup>®</sup> Mix Wheel

For removing minor scratches, oxide and paint.  
For a medium to fine finish.



### Technical Data:

Dimensions (mm)	Mount	Max. speed (rpm)	Material	Pkg. unit	Grit (K)	Article number
Ø 40 x 20	6 mm steel shaft	9,500	Nylon fleece in combination with abrasive cloth	10	80	14080
					150	14150
					240	14240
Ø 60 x 30	6 mm steel shaft	9,500	Nylon fleece in combination with abrasive cloth	10	80	14081
					150	14151
					240	14241



Suitable for

**ALL METALS · WOOD · HARD PLASTICS**

## MINI MAX<sup>®</sup> Fleece Wheel

For matt finishes, fine grinding and removing oxide.  
For smoothing wood fibres and hard plastic.



### Technical Data:

Dimensions (mm)	Mount	Max. speed (rpm)	Material	Pkg. unit	Grit (Fleece)	Grit (Fleece)	Grit (Approx. grit)	Article number
Ø 40 x 20	6 mm steel shaft	9,000	Flexible nylon fleece impregnated with grit	10	Coarse	M	80	13001
					Medium	F	180	13002
					Fine	VF	280	13003
					Superfine	SF	400	13004
Ø 60 x 30	6 mm steel shaft	9,000	Flexible nylon fleece impregnated with grit	10	Extra coarse	C	60	13010
					Coarse	M	80	13011
					Medium	F	180	13012
					Fine	VF	280	13013
					Superfine	SF	400	13014



Suitable for

**STAINLESS STEEL · NON-FERROUS METALS · HARD PLASTICS**

## MINI MAX® Felt Polishing Tip



First-rate merino felt tips for polishing in corners, cavities and recesses. Only for use with polishing pastes or cream.

### Technical Data:

Dimensions (mm)	Mount	Shape	Material	Pkg. unit	Article number
Ø 20 x 25	6 mm steel shaft	Round	Merino felt	10	10020
Ø 30 x 35	6 mm steel shaft	Cylindrical	Merino felt	10	10021
Ø 15 x 30	6 mm steel shaft	Conical	Merino felt	10	10022



Suitable for

**POLISHING RINGS · WIRE WHEELS**

## MINI MAX® Clamping Shaft

Clamping shaft for polishing rings and wire wheels used with the MINI MAX®, flexible shaft, drills, etc.

**FOR SUITABLE POLISHING RINGS, SEE PAGE 130 ONWARDS.**

### Technical Data:

Mount (mm)	Material	Max. speed (rpm)	Pkg. unit	Article number
6 mm steel shaft	Steel, blackened	8,000	1	10017





Suitable for

**STEEL · STAINLESS STEEL · NON-FERROUS METALS · WOOD**

# CLEAN Disc MCD

for drills, etc.

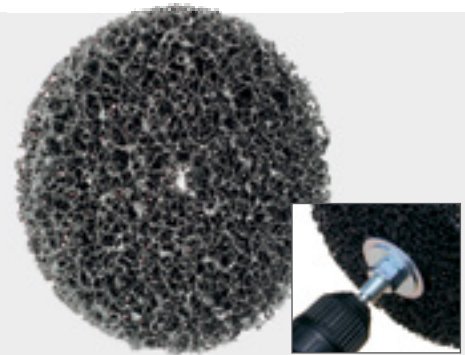

Cleans and removes pore-deep paint, rust, scale and dirt on all materials. Similar effect to sand-blasting; as it cleans without removing material. Ideal for car bodywork, the automotive industry, shipyards and renovation work by commercial decorators and builders.

**Technical Data:**

Dimensions (mm)	Mount	Max. speed (rpm)	Material thickness (mm)	Pkg. unit	Article number
Ø 115	For clamping shaft	5,000	13	10	61115
Ø 150	For clamping shaft	4,000	13	10	61150
Clamping spindle	8 mm steel shaft			1	61151



Suitable for

**STEEL · STAINLESS STEEL · NON-FERROUS METALS**

## MINI MAX<sup>®</sup> Stainless Steel Wire Wheel



For deburring and cleaning weld seams, paint, rust, etc.

### Technical Data:

Dimensions (mm)	Mount (mm)	Wire thickness (mm)	Max. speed (rpm)	Material	Pkg. unit	Article number
Ø 60 x 10	6 mm steel shaft	0.2	15,000	Stainless steel wire	5	10019



Suitable for

**STEEL · STAINLESS STEEL · NON-FERROUS METALS**

## MINI MAX<sup>®</sup> Stainless Steel Wire Brush



For removing scale and cleaning weld seams, removing paint and rust in corners, etc.

### Technical Data:

Dimensions (mm)	Mount (mm)	Speed (rpm)	Material	Pkg. unit	Article number
Ø 10 x 100	6 mm steel shaft	max. 15,000	Stainless steel wire	5	10023



Suitable for

**POLISHING RINGS - WIRE WHEELS**

## MINI MAX® Clamping Shaft

Clamping spindle for use with polishing rings and wire wheels used with the MINI MAX®, the flexible shaft, drills, etc.

**FOR SUITABLE WIRE WHEELS (MAXIMUM WIDTH 12 mm) , SEE PAGE 137 ONWARDS.**

### Technical Data:

Mount (mm)	Material	Max. speed (rpm)	Pkg. unit	Article number
6 mm steel shaft	Steel, blackened	8,000	1	10017





# MINI MAX<sup>®</sup> PRO

Minimum size.  
Maximum versatility.

Multipurpose grinder with many applications for professional use, for example, of shaft tools (mini angle grinding, mini linear grinding, etc.)

NEW



### FEATURES

- Indispensable for maintenance, repairs, fitting work, motor vehicles, paint workshops and much more
- For grinding jobs in hard to reach places (e.g. corners, edges, internal tanks), coarse grinding, fine grinding, satin finish, matt finish, polishing to a mirror finish, mini-cutting and cut-off grinding
- Also ideal for all ROLOC<sup>™</sup> systems
- Comprehensive range of grinding tools for all grinding jobs on stainless steel, steel, non-ferrous metals, aluminium, wood and plastics
- Ideal drive motor for flexible shafts with a 6 mm shaft
- Can be used with the clamp for mounting or suspending the drive motor when working with the flexible shaft



### Technical Data: MINI MAX® PRO Machine

Plug type	Cable type	Mains connection (V ~ Hz)	Power (W)	Speed (rpm)	Mount (mm)	Weight (g)	Pkg. unit	Article number
EU (C+F)	Permanent connection	220 – 240 ~ 50 – 60	850	3,700 – 13,000	Collet for Ø 6	2,700	1	10002

Accessories included in package: 1 MINI MAX® PRO machine, 1 x 4 m cable, 1 backing pad, 1 flap disc 60 grit



Turning the guide handle through 90° turns the linear grinder into a mini angle grinder. Use with flexible shaft and clamp or MINI FIX backing pad.



# MINI MAX<sup>®</sup> PRO Professional Set

The practical set that comes in a case



This practical set consists of a MINI MAX<sup>®</sup> grinding and polishing machine and a versatile accessory package – all ready to go in a practical, sturdy carry case.

**Technical Data:**

Plug type	Cable type	Mains connection (V ~ Hz)	Power (W)	Speed (rpm)	Mount (mm)	Pkg. unit	Article number
EU (C+F)	Permanent connection	220 – 240 ~ 50 – 60	850	3,700 – 13,000	Collet for Ø 6	1	10003

**Contents of Set:**

- 1 MINI MAX<sup>®</sup> PRO machine 850 watts
- 1 Sturdy carry case
- 2 Mini polishing pastes (white and blue)
- 1 Brilliance Clean 50 ml
- 1 INOX PROTECT 50 ml
- 1 Microfibre cloth
- 1 BRIGHTEX<sup>®</sup> Softclean powder

**Linear grinding:**

- 1 MINI MAX<sup>®</sup> flap wheel
- 1 MINI MAX<sup>®</sup> fleece wheel
- 1 MINI MAX<sup>®</sup> mix wheel
- 2 MINI MAX<sup>®</sup> expansion rollers
- 8 MINI MAX<sup>®</sup> zirconium sleeves
- 2 MINI MAX<sup>®</sup> felt polishing tips

**Circular grinding:**

- 1 MINI FIX Backing Pad
- 1 MINI FIX Clean
- 2 MINI FIX flap discs
- 2 MINI FIX SC fleece discs
- 4 MINI FIX SuperPolish discs

# Flexible Shaft

Flexible shaft with steel core for working in cramped and particularly hard-to-access places. All grinding tools in the MINI MAX® and MINI FIX range can also be used with a flexible shaft.

## Technical Data:

Length (mm)	Collet (mm)	Mount	Max. speed (rpm)	Can be used with (Ø mm)	Pkg. unit	Article number
1,400	Ø 6	6 mm steel shaft	25,000	Up to 6	1	10010



ACCESSORIES



## Machine Holder

Practical steel clamp and machine holder – supplied with powder-coated clamp bolt. Used for securely fastening the unit when this is used, for example, as a free-standing grinder. The holder can be inserted into a vice or suspended from a hook (for e.g. on the ceiling). Ideal for two-handed jobs and for use with a flexible shaft.

## Technical Data:

Description of article	Material	Pkg. unit	Article number
Clamp and suspended holder incl. clamp bolt	Steel, powder-coated	1	10009



ACCESSORIES





# MULTI MAX<sup>®</sup>

The all-in-one work station



### FEATURES

- 2 shaft mounts for grinding discs (e.g. flap discs) and for grinding wheels
- Can be used with the sophisticated FIX HOOK & LOOP quick-change system
- Powerful, efficient three-phase motor with 750-watt output and very high torque
- Constant speed of 2800 rpm
- Transparent, folding grinding guard (to protect against flying sparks and dust)
- Roller support for accurate working on the grinding wheel side
- Adjustable support rail with protective cover for grinding discs up to Ø 180 mm
- Drive motor for flexible shaft for grinding and polishing with shaft tools
- Saves energy and has an extremely low noise level in comparison to stationary belt grinding machines

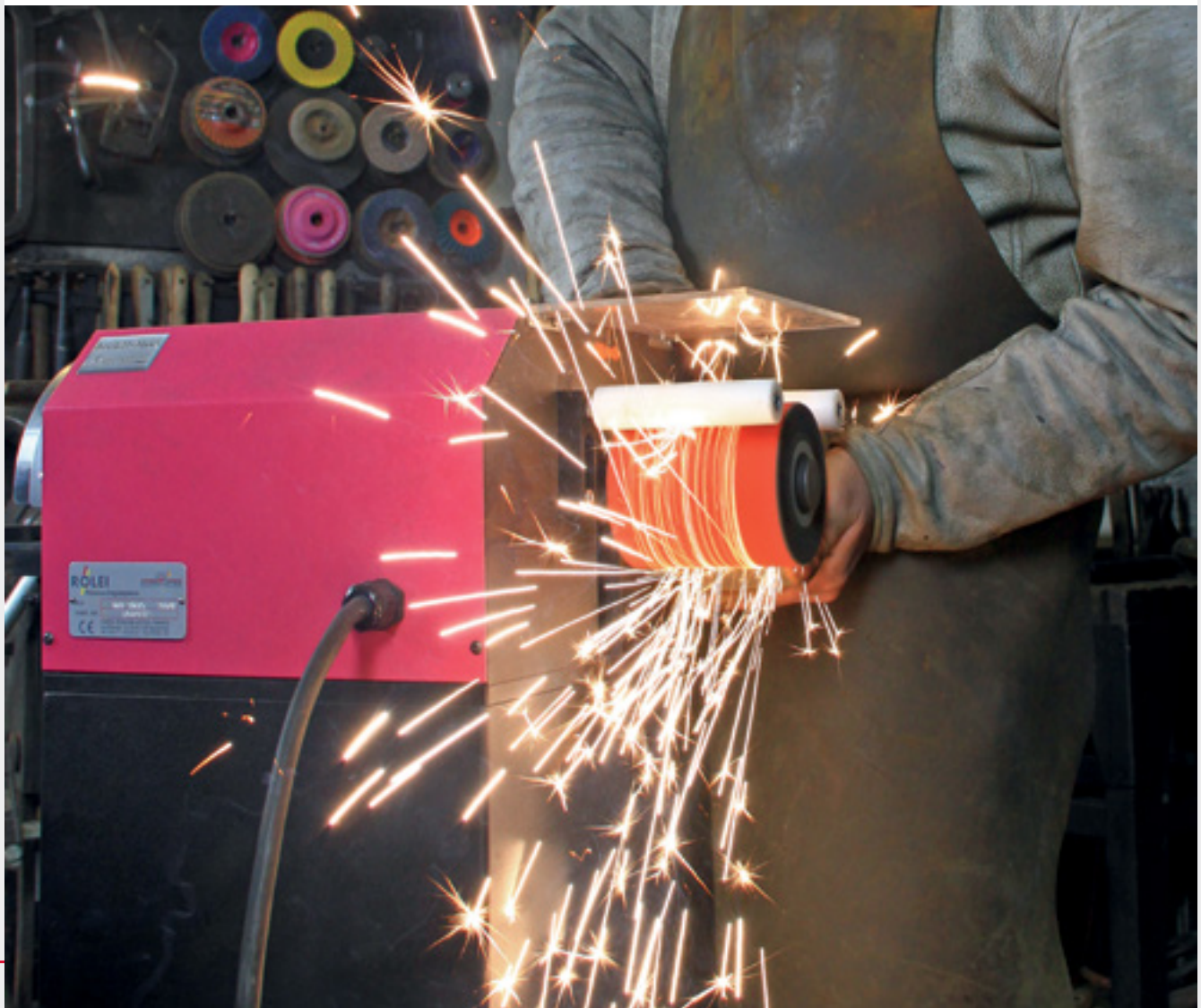

## Technical Data: MULTI MAX<sup>®</sup> Machine

Dimensions (mm)	Plug type	Mains connection (V ~ Hz)	Power (W)	Speed (rpm)	Weight (kg)	Pkg. unit	Article number
385 x 325 x 660	EU	380 ~ 50	750	2,800	23	1	30404

Accessories included in package: 1 MULTI MAX<sup>®</sup> machine

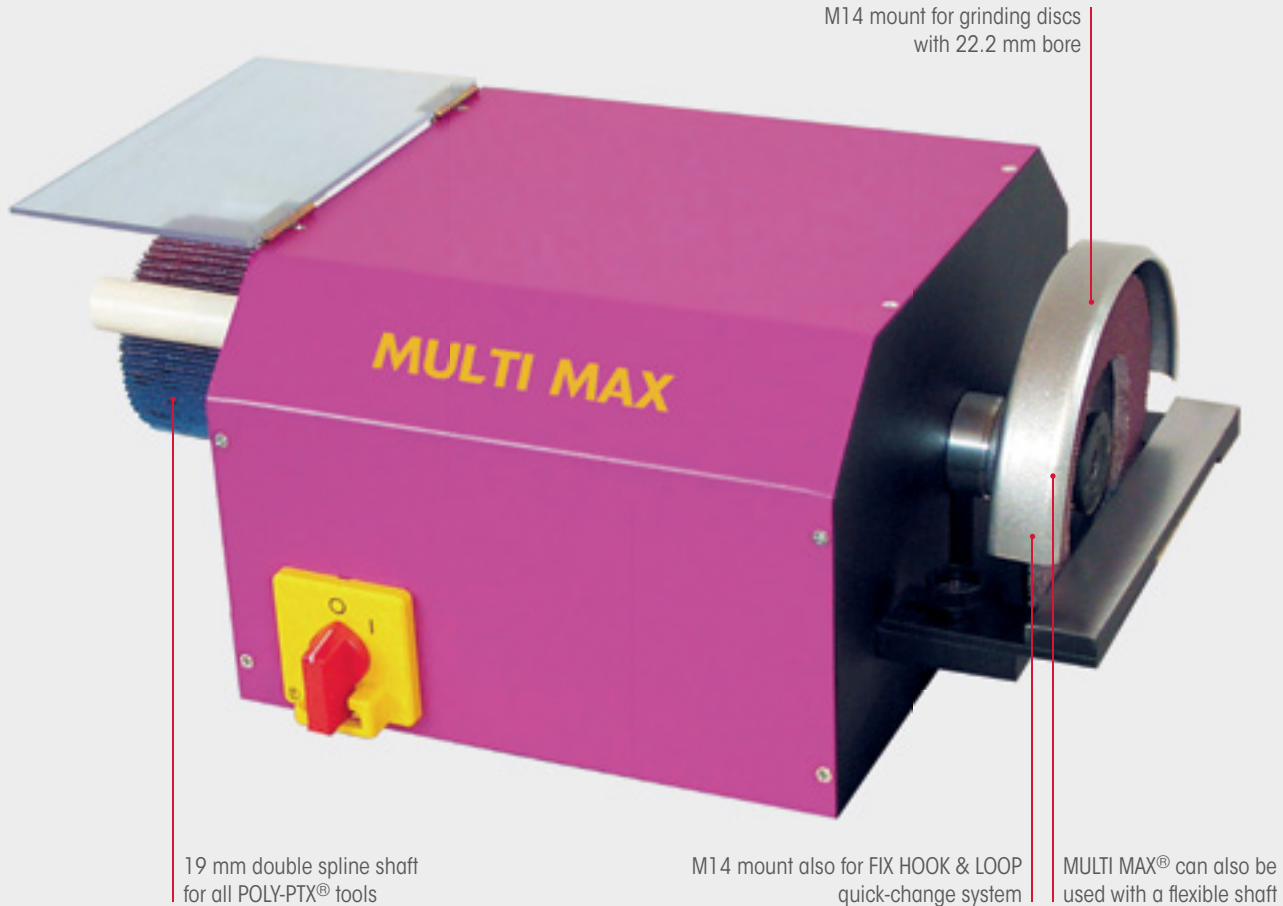

Interchangeable flexible shaft for grinding and polishing jobs on cumbersome workpieces.  
**SEE PAGE 113**



Shaft mount for all tools in the POLY-PTX<sup>®</sup> system (with 19 mm double spline shaft). Also for all tools in the Eco Smart system (with Eco Smart adapter).



M14 mount for grinding discs with 22 mm bore (e.g. for flap discs and polishing discs).



Uses the practical HOOK & LOOP quick-change system.  
**SEE PAGE 86**

## MULTI MAX<sup>®</sup> Professional Set

The mini workshop



For lightning fast deburring, trimming, grinding, brushing, polishing, etc. grinding rollers for POLY-PTX<sup>®</sup> accessories for longitudinal grinding, matting and polishing, flap discs for circular grinding and fine grinding. FIX Hook & Loop system for grinding, polishing and much more are included in the set

### Technical Data:

Plug type	Mains connection (V ~ Hz)	Power (W)	Speed (rpm)	Dimensions (mm)	Pkg. unit	Article number
3-phase	380 ~ 50	750	2,800	385 x 325 x 660	1	30400

### Contents of Set:

1 MULTI MAX<sup>®</sup> machine 380 V

#### Circular grinding:

- 1 Special adhesive backing plate  
Ø 150 mm
- 4 FIX zirconium discs
- 2 FIX flap discs
- 2 FIX SC fleece discs
- 1 Plan flap disc Ø 170 mm
- 1 Protective cover Ø 180 mm

#### Linear grinding:

- 1 SC fleece wheel Ø 115 x 110 mm
- 2 Flap wheels Ø 105 x 50 mm
- 1 Mix wheel Ø 115 x 100 mm
- 1 Set of spacer rings





# Flexible Shaft

Now there's an even wider range of applications for the versatile MULTI MAX<sup>®</sup> mini workshop. With the new flexible drive shaft, sturdy 7 mm core and interchangeable M14 thread, the machine can be upgraded to a professional drive motor. The MULTI MAX<sup>®</sup> provides you with a powerful professional motor for all applications. Ideal for 6 mm shaft tools and can be used with an adapter for polishing rings up to Ø 150 mm. Can also be used with the VARILEX<sup>®</sup> WSF 1800!



**Technical Data:**

Length (mm)	Collet (mm)	Mount	Max. speed (rpm)	Can be used with (Ø mm)	Can be used with adapter (diameter of polishing rings in mm)	Pkg. unit	Article number
1,420	Ø 6	M14 thread	12,000	Up to 60	Up to 150	1	10014



## MULTI MAX<sup>®</sup> Machine Stand

Sturdy steel machine stand with a black powder coating finish. Comes supplied with nuts and bolts for securing the machine. For working safely in a standing position.



**Technical Data:**

Dimensions (L x W x H) (mm)	Weight (kg)	Pkg. unit	Article number
400 x 350 x 830	20	1	30420





**Streak-free  
handheld  
satin finish!**



# LINEAR GRINDING – SATIN FINISHING

## GRINDING AND BLENDING ..... 116

HellFire® Ceramic Hybrid Sleeve .....	116
Ceramic Sleeve .....	116
Zirconium Sleeve .....	117
Flap Wheel .....	118
Gum Wheel .....	119
Cut & Polish Fleece Wheel (S/C) .....	119
Eco Smart Flap Wheel .....	120
Trizact™ Sleeve .....	121

## FINISHING AND FINE GRINDING ..... 122

SC Fleece Sleeve .....	122
Mix Wheel .....	123
Fleece Wheel .....	124
Fleece Top Wheel .....	125
Eco Smart Mix Wheel .....	126
Eco Smart Fleece Wheel .....	127

## POLISHING ..... 128

BRIGHTEX® Polishing Sleeve .....	128
SuperPolish Sleeve .....	129
Felt Sleeve .....	129
Felt Wheel .....	130
Cotton Ring (impregnated) .....	130
Mirror Finishing Ring Medium .....	131
Mirror Finishing Ring Soft .....	131
BRIGHTEX® Polishing Paste .....	132
BRIGHTEX® Softclean Powder .....	133
BRIGHTEX® Non-Scratch Cloth .....	133
Polishing Paste .....	134
Pink Polishing Cream .....	134
Microfibre Cloths .....	134

## CLEANING ..... 135

Clean Wheel .....	135
Clean Wheel Soft .....	136

## TECHNICAL WHEELS ..... 137

POLY-PTX® Wire Wheel .....	137
POLY-PTX® INOX Wire Wheel .....	137
Bristle Wheel .....	138
Fibre Wheel .....	138

## POWER TOOLS ..... 140

POLY-PTX® 800 PROFESSIONAL .....	140
POLY-PTX® 800 Professional Set .....	142
POLY-PTX® 800 Metal Set .....	143
POLY-PTX® 800 Wood Set .....	144
POLY-PTX® Expansion Roller .....	145
POLY-PTX® Inflatable Expansion Roller .....	145
POLY-PTX® Grinding Belt Roller .....	146
POLY-PTX® Eco Smart Adapter .....	147
POLY-PTX® Eco Smart Expansion Roller .....	148
POLY-PTX® Eco Smart Grinding Belt Roller .....	148
QUICK-LOCK Cable .....	149
Aluminium Suction Cover .....	149
Special Handle Bar .....	150
Spacer Ring Set .....	150
POLY-PTX® Special Adhesive Tape .....	151
Stainless Steel Cover Plate .....	151

Suitable for

**ALL METALS**

## HellFire<sup>®</sup> Ceramic Hybrid Sleeve

HellFire<sup>®</sup> ceramic hybrid sleeve made from top quality ceramic cloth with several times the service life of conventional zirconium sleeves for all metals. Aggressive removal even on materials which are difficult to machine such as stainless steel, titanium, bronze, etc. Delivers particularly cool and non-slip grinding.

**ONLY IN COMBINATION WITH AN EXPANSION ROLLER – SEE PAGE 145/148 ONWARDS.**



### Technical Data:

Dimensions (mm)	Material	Pkg. unit	Grit (K)	Article number
Ø 90 x 100	Ceramic hybrid fabric	10	40	42540
			60	42560

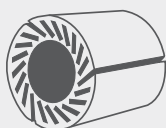

Suitable for

**STEEL · STAINLESS STEEL**

## Ceramic Sleeve

Ceramic sleeve made from top quality ceramic fabric with several times the service life of conventional zirconium sleeves. For removing deep scratches, rust, scale and spot welds.

**ONLY IN COMBINATION WITH AN EXPANSION ROLLER – SEE PAGE 145/148 ONWARDS.**



### Technical Data:

Dimensions (mm)	Material	Pkg. unit	Grit (K)	Article number
Ø 90 x 100	Ceramic fabric	10	40	42440
			60	42460
			80	42480

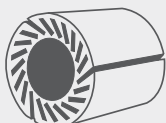

Suitable for

**STEEL · STAINLESS STEEL**

## Zirconium Sleeve

Grinding sleeves made from top quality zirconium fabric for removing deep scratches, rust, scale and spot welds.

**ONLY IN COMBINATION WITH AN EXPANSION ROLLER – SEE PAGE 145/148 ONWARDS.**



### Technical Data:

Dimensions (mm)	Material	Pkg. unit	Grit (K)	Article number
Ø 90 x 100	Zirconium abrasive cloth	10	40	42040
			60	42060
			80	42080
			120	42120
			150	42150
			180	42180
Ø 90 x 50	Zirconium abrasive cloth	10	40	42301
			60	42302
			80	42303
			120	42304
			150	42305
			180	42306

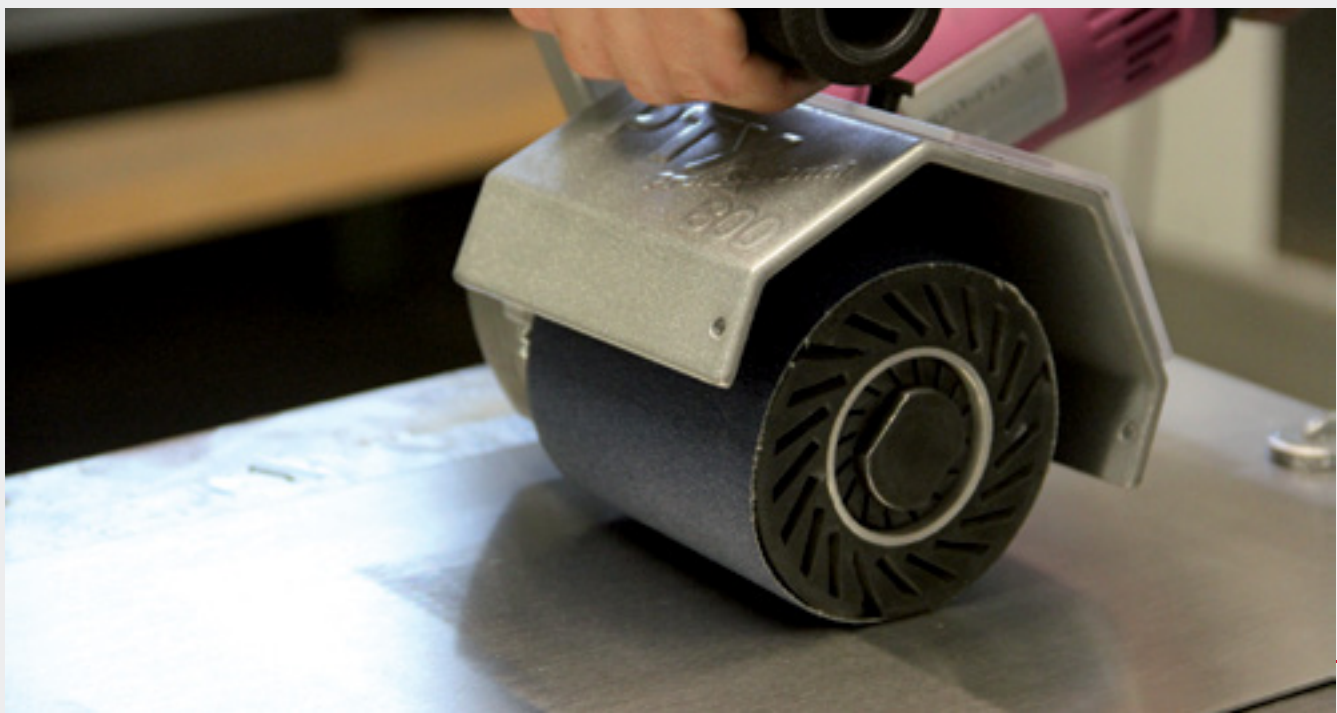
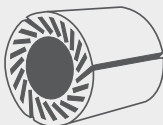



Suitable for

**ALL METALS · WOOD**

## Flap Wheel

Grinding flap wheel for surface grinding



With a vibration-damping core for single, double and quadruple spline shafts, ensuring the wheel runs perfectly. For removing rust, oxide layers, paint, scratches and for textured and satin finishes on all metals.

### Technical Data:

Dimensions (mm)	Ideal speed (rpm)	Max. speed (rpm)	Material	Pkg. unit	Grit (K)	Article number
Ø 105 x 100 x 19	1,000 – 2,000	5,000	High quality corundum	4	40	41440
					60	41460
					80	41480
					120	41490
					180	41491
Ø 105 x 50 x 19	1,000 – 2,000	5,000	High quality corundum	4	24	41024
					40	41040
					60	41060
					80	41080
					120	41120
					180	41180
					240	41240



Suitable for

**STEEL · STAINLESS STEEL · NON-FERROUS METALS · WOOD**

# Gum Wheel

Soft gum wheel with silicon grit for improved workpiece adjustment. For eliminating minor scratches and removing black scale; ideal for linear grinding operation with a brightly gleaming and textured decorative finish on stainless steel and non-ferrous metals. Also used on wood for smoothing.

**Technical Data:**

Dimensions (mm)	Ideal speed (rpm)	Max. speed (rpm)	Pkg. unit	Grit (K)	Article number
Ø 105 x 100 x 19	1,000 – 2,000	5,000	2	60	45061
				180	45181
Ø 105 x 50 x 19	1,000 – 2,000	5,000	4	60	45060
				180	45180



Suitable for

**STAINLESS STEEL · NON-FERROUS METALS**

# Cut & Polish Fleece Wheel (S/C)

Due to an extremely high grit content combined with a silicon carbide grit mix, this recognized satin finish (industrial grinding K240-280) can be achieved very quickly on stainless steel. You can work directly on the bare sheet metal of untreated stainless steel surfaces with no scratches. Any oxide layers will be quickly removed by the high grit content. This produces a very attractive-looking effect through the bright shining finish.

**Technical Data:**

Dimensions (mm)	Material	Ideal speed (rpm)	Max. speed (rpm)	Pkg. unit	Grit (K)	Article number
Ø 115 x 100 x 19	Silicon carbide	1,000 – 2,000	5,000	2	240 – 280	43004



Suitable for

**ALL METALS · WOOD**

## Eco Smart Flap Wheel

Flap wheel for surface grinding in the Eco Smart version (eliminating the cost of the inner core and cast resin) for removing rust, oxide layers, scratches and for applying a textured and satin finish on all metals.

Easy-to-use quick-release function for Eco Smart rollers in any position on the Eco Smart adapter.



**ONLY IN COMBINATION WITH AN ECO SMART ADAPTER – SEE PAGE 147.**

### Technical Data:

Dimensions (mm)	Material	Ideal speed (rpm)	Max. speed (rpm)	Pkg. unit	Grit (K)	Article number
Ø 105 x 100 x 45	High quality corundum	1,000 – 2,000	5,000	4	40	47211
					60	47212
					80	47213
					120	47214
					180	47215
Ø 105 x 50 x 45	High quality corundum	1,000 – 2,000	5,000	4	24	47201
					40	47202
					60	47204
					80	47205
					120	47206
					180	47207
					240	47208

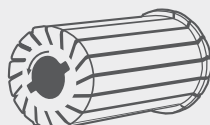
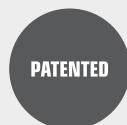

Suitable for

**STEEL · STAINLESS STEEL**

## Trizact™ Sleeve

New type of abrasive cloth with pyramid-shaped grit structure. Saves on several operating steps and has a high rate of material removal with a fine finish. Great for removing scratches and spot welds. Ideal for pre-polishing into subsequent mirror finish polishing. Leaves only minor surface roughness behind.

**ONLY IN COMBINATION WITH AN EXPANSION ROLLER – SEE PAGES 145 TO 148.**



### Technical Data:

Dimensions (mm)	Pkg. unit	Grit (Trizact™)	Grit (K)	Removes material like (Approx. grit)	Article number
Ø 90 x 100	10	A160	120	24	42280
		A100	220	36	42270
		A65	280	40	42265
		A45	400	50	42245
		A30	600	60	42230
		A16	1,200	80	42216
		A06	2,000	120	42206
Ø 90 x 50	10	A160	120	24	42327
		A100	220	36	42326
		A65	280	40	42325
		A45	400	50	42324
		A30	600	60	42323
		A16	1,200	80	42322
		A06	2,000	120	42321

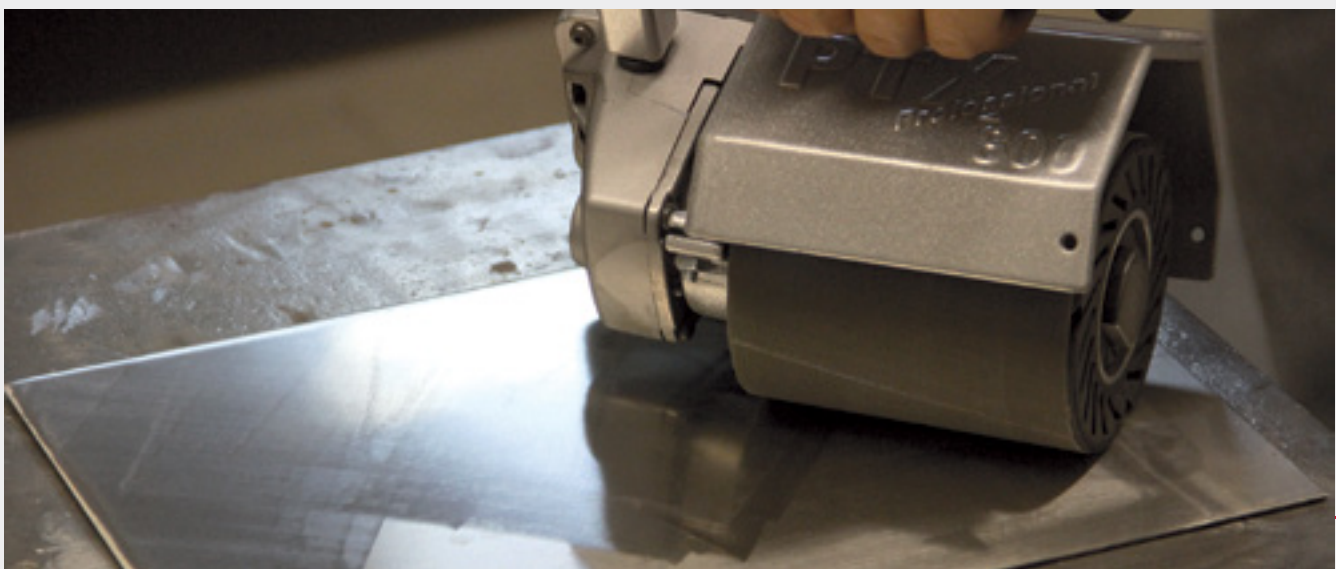
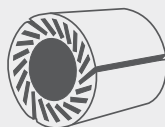
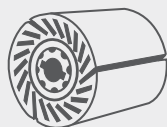



Suitable for

**STEEL · STAINLESS STEEL · NON-FERROUS METALS · WOOD · HARD PLASTICS**

## SC Fleece Sleeve

Technical surface conditioning fleece – ideally suited for removing oxide layers, deburring and fine grinding. Outstanding for decorative satin finish and linear grinding, while at the same time eliminating minor scratches (possibly finish with POLY-PTX® fleece wheel of 60, 80 or 180 grit to eliminate grinding transitions).

**ONLY IN COMBINATION WITH AN EXPANSION ROLLER – SEE PAGES 145 TO 148.**



### Technical Data:

Dimensions (mm)	Pkg. unit	Grit (K)	Colour (Fleece)	Grit (Fleece)	Article number
Ø 90 x 100	4	80	Brown	Coarse	42010
		180	Red	Medium	42011
		280	Blue	Fine	42012
		400	Grey	Superfine	42009
Ø 90 x 50	4	80	Brown	Coarse	42311
		180	Red	Medium	42312
		280	Blue	Fine	42313
		400	Grey	Superfine	42314

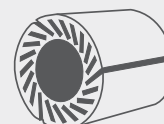

Suitable for

**STEEL · STAINLESS STEEL · WOOD**

## Mix Wheel

Combined fleece/grinding flap wheel



Grit-impregnated, top quality nylon fleece with top quality corundum abrasive cloth for uniform fleece and abrasive cloth usage. This wheel has a more aggressive impact than pure fleece wheels due to this. With a vibration-damping core for single, double and quadruple spline shafts, thus ensuring the disc runs perfectly. (In addition, mechanically balanced – only available from Eisenblätter. See "Balancing" information on page 125).

**Metal:** Applies a matt and satin finish and removes minor scratches, rust, oxide, etc.

**Wood:** Smooths the surface and removes old paint, dirt, etc.

### Technical Data:

Dimensions (mm)	Ideal speed (rpm)	Max. speed (rpm)	Pkg. unit	Grit (K)	Article number
Ø 115 x 100 x 19	1,000 – 2,000	5,000	4	60	44061
				80	44101
				120	44121
				180	44181
Ø 115 x 50 x 19	1,000 – 2,000	5,000	4	60	44060
				80	44100
				120	44120
				180	44180
Ø 105 x 100 x 19	1,000 – 2,000	5,000	4	60	44061α
				80	44101α
				120	44121α
				180	44181α
Ø 105 x 50 x 19	1,000 – 2,000	5,000	4	60	44060α
				80	44100α
				120	44120α
				180	44180α



Suitable for

**STAINLESS STEEL · NON-FERROUS METALS · WOOD**

## Fleece Wheel

Compact high-tech fleece wheel made from compressed nylon grit fleece for industrial grinding



It is possible to obtain a working width of 110 mm (fits all satin finish tools) with 60, 80 and 180 grits and a diameter of 115 mm. This is due to the tightening screw being sunk into the wheel allowing you to grind up to the edge. With a vibration-damping core for single, double and quadruple spline shafts, ensuring the wheel runs perfectly. (In addition this wheel is mechanically balanced – only available from Eisenblätter. See "Balancing" information on page 125).

### Technical Data:

Dimensions (mm)	Ideal speed (rpm)	Max. speed (rpm)	Pkg. unit	Grit (K)	Article number
Ø 115 x 110 x 19	1,000 – 2,500	5,000	4	60	43061
				80	43101
				180	43181
Ø 115 x 100 x 19	1,000 – 2,500	5,000	4	280	43281
				400	43401
				600	43601
				900	43901
Ø 115 x 50 x 19	1,000 – 2,500	5,000	4	60	43060
				80	43100
				180	43180
				280	43280
				400	43400
				600	43600
Ø 105 x 100 x 19	1,000 – 2,500	5,000	4	60	43061a
				80	43101a
				180	43181a
				280	43281a
				400	43401a
				600	43601a
Ø 105 x 50 x 19	1,000 – 2,500	5,000	4	60	43060a
				80	43100a
				180	43180a
				280	43280a

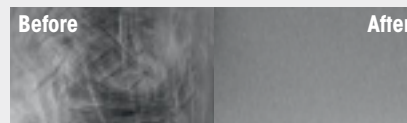

Suitable for

**ALL METALS · WOOD**

## Fleece Top Wheel

Fleece wheel compressed with polyurethane foam. Several times the service life of "pure fleece wheels". With a vibration-damping core for single, double and quadruple spline shafts, thus ensuring the disc runs perfectly. Achieves strong linear structures with a decorative shine and fine deburring of perforated sheet metal.



### Technical Data:

Dimensions (mm)	Ideal speed (rpm)	Max. speed (rpm)	Pkg. unit	Grit (K)	Article number
Ø 112 x 100 x 19	1,000 – 3,000	5,000	2	80	43102
				180	43103
				280	43104
				400	43105
				600	43106
				900	43107



### INFO: BALANCING

Only linear grinding wheels (fleece and mix wheels) from Eisenblätter are balanced: the quality of the surface finish crucially depends on whether the grinding wheels run perfectly. The individual grinding wheels are often out of balance due to factors relating to production and raw materials, which in turn results in an imbalance and vibration. This is transmitted to the workpiece – resulting in chatter marks and shadows and therefore producing a result which is not clean. Eisenblätter is the only supplier in the world to have found a solution for this problem and supplies its fleece and mix wheels in 100 % perfect condition.

Eisenblätter's fleece and mix wheels are balanced by a machine specifically designed for the purpose (similar to wheel-balancing for vehicles). The machine balances out the imbalance using a counterweight, with the result that the wheel runs perfectly. This in turn guarantees a high quality of grinding and satin finish. Surfaces can be machined flawlessly and the process eliminates the time and cost spent on finishing workpieces which are needed when surfaces are finished with non-balanced grinding wheels.

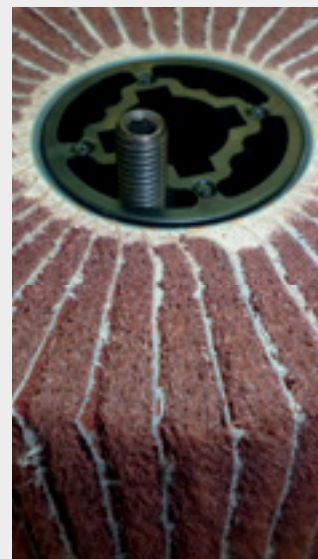



Suitable for

**STEEL · STAINLESS STEEL · WOOD**

## Eco Smart Mix Wheel

Combined fleece/grinding flap wheel

Grit-impregnated, top quality nylon fleece with top quality corundum abrasive cloth for uniform fleece and abrasive cloth usage in the Eco Smart version (eliminating the cost of the inner core and cast resin and allows for working widths of up to 150 mm). Has a more aggressive impact than pure fleece wheels.

**Metal:** Applies a matt and satin finish and removes minor scratches, rust, oxide, etc.

**Wood:** Smooths the surface and removes old paint, dirt, etc.

**ONLY IN COMBINATION WITH AN ECO SMART ADAPTER – SEE PAGE 147.**



### Technical Data:

Dimensions (mm)	Ideal speed (rpm)	Max. speed (rpm)	Pkg. unit	Grit (K)	Article number
Ø 105 x 150 x 45	1,000 – 2,000	5,000	2	80	47322
				180	47323
Ø 105 x 100 x 45	1,000 – 2,000	5,000	4	60	47311
				80	47312
				180	47313
Ø 105 x 50 x 45	1,000 – 2,000	5,000	4	60	47301
				80	47302
				180	47303



The Eco Smart System makes it possible to machine working widths of up to 150 mm as well!

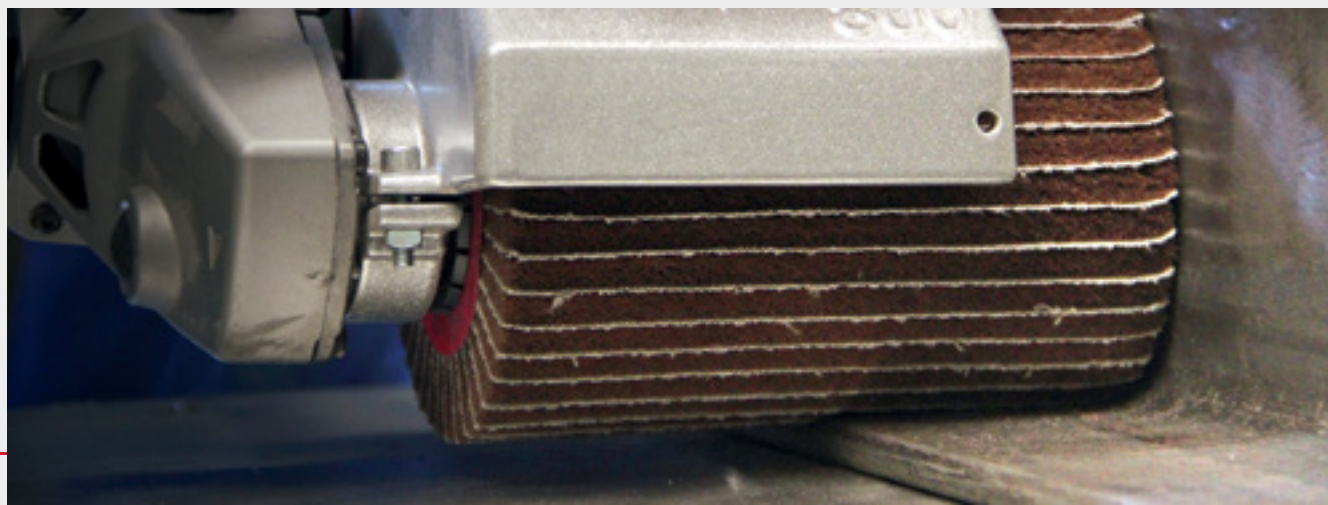

Suitable for

**STAINLESS STEEL · NON-FERROUS METALS · WOOD**

## Eco Smart Fleece Wheel



Compact high-tech fleece wheel made from compressed nylon fleece.

High-tech fleece wheel in the Eco Smart version (eliminating the cost of the inner core and cast resin and allows for working widths of up to 150 mm). Achieves an industrial finish (matt and satin) with no shadow. Also used for pre-polishing, removing oxide layers and smoothing "pre-ground" sheet metal and smoothing surfaces.

**CAN ONLY BE USED WITH AN ECO SMART ADAPTER – SEE PAGE 147.**

### Technical Data:

Dimensions (mm)	Ideal speed (rpm)	Max. speed (rpm)	Pkg. unit	Grit (K)	Article number
Ø 105 x 150 x 45	1,000 – 2,000	5,000	2	80	47422
				180	47423
Ø 105 x 100 x 45	1,000 – 2,000	5,000	4	60	47411
				80	47412
				180	47413
				280	47414
				400	47415
Ø 105 x 50 x 45	1,000 – 2,000	5,000	4	60	47401
				80	47402
				180	47403
				280	47404
				400	47405



The Eco Smart System allows for perfect grinding right into the corners (sheet metal upstands), since all Eco Smart tools can be placed anywhere on the Eco Smart adapter.

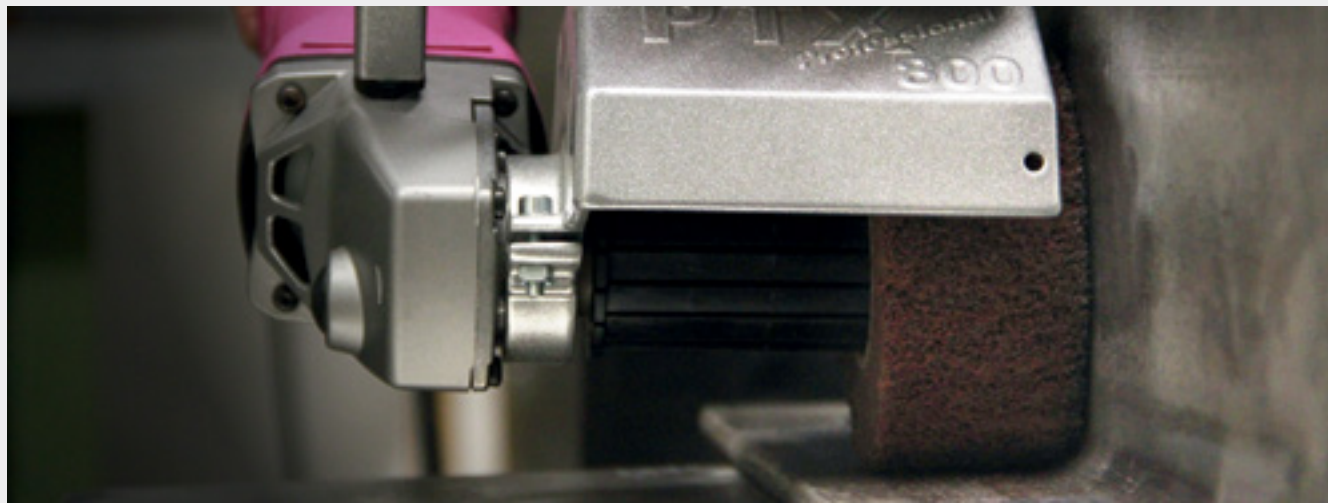

Suitable for

**ALL METALS**

# BRIGHTEX<sup>®</sup> Polishing Sleeve



Polishing material that is already impregnated with BRIGHTEX<sup>®</sup> polishing paste removes the hassle and time-consuming business of applying pastes and creams to give an untreated metal a shadow-free mirror finish.

**ONLY IN COMBINATION WITH AN EXPANSION ROLLER – SEE PAGES 145 TO 148.**

## FEATURES

- For reconditioning surfaces that are mirror-polished mechanically
- Ideal for use with polishing machines and hand-held polishing tools
- For best results, use Eisenblätter care and cleaning products for removing polish residues
- Completely new high-tech paste formulation for metals

### BRIGHTEX<sup>®</sup> Berry:

- For applying a rapid high-gloss polish to all metals
- Pre-polish and main polish in one – saves additional working steps
- For immediate use without the need for additional pastes and creams!

### BRIGHTEX<sup>®</sup> Sun:

- A mirror shine that's almost as if chrome-plated – the perfect finish
- For a final high gloss shine on polished metals
- For removing any leftover clouding and smears on all metals

## Technical Data:

Version	Dimensions (mm)	Ideal speed (rpm)	Max. speed (rpm)	Application	Pkg. unit	Article number
Berry	Ø 90 x 100	1,000 – 3,000	5,000	Super polish	2	42014
Berry	Ø 90 x 50	1,000 – 3,000	5,000	Super polish	4	42332
Sun	Ø 90 x 100	1,000 – 3,000	5,000	Top finish	2	42015
Sun	Ø 90 x 50	1,000 – 3,000	5,000	Top finish	4	42333

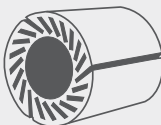

Suitable for

**ALL METALS**

# SuperPolish Sleeve

Revolutionary special fleece. Used with polishing pastes and creams for a shiny mirror finish on stainless steel and non-ferrous metals which leaves no smears or shadows. Always use a separate SuperPolish sleeve for each paste and cream as it is important to not mix different grit sizes.

**ONLY USE IN COMBINATION WITH AN EXPANSION ROLLER (SEE PAGES 145-148) AND POLISHING PASTES (SEE PAGES 132-134) OR POLISHING CREAM (SEE PAGE 134).**



### Technical Data:

Dimensions (mm)	Material thickness (mm)	Ideal speed (rpm)	Max. speed (rpm)	Material	Pkg. unit	Article number
Ø 90 x 100	5	1,000 – 3,000	5,000	Polishing fleece	4	42013n
Ø 90 x 50	5	1,000 – 3,000	5,000	Polishing fleece	4	42331



Suitable for

**STAINLESS STEEL · NON-FERROUS METALS · HARD PLASTICS**

# Felt Sleeve

First-rate merino felt sleeve, continuous throughout with no joins. For a rapid mirror finish using polishing pastes and creams and no scratches or smears. Always use a separate felt sleeve for each paste and cream as it is important to not mix different grit sizes.

**ONLY USE IN COMBINATION WITH AN EXPANSION ROLLER (SEE PAGES 145-148) AND POLISHING PASTES (SEE PAGES 132-134) OR POLISHING CREAM (SEE PAGE 134).**



### Technical Data:

Dimensions (mm)	Material thickness (mm)	Ideal speed (rpm)	Max. speed (rpm)	Material	Pkg. unit	Article number
Ø 90 x 100	5	1,000 – 3,000	5,000	Merino felt	4	42013





Suitable for

**STAINLESS STEEL · NON-FERROUS METALS · HARD PLASTICS**

# Felt Wheel

First-class merino felt wheel made from special felt material with a vibration-damping core for single, double and quadruple spline shafts, thus ensuring the wheel runs perfectly. Can be used with greater contact pressure. Do not use different pastes or creams on the same felt wheel because leftover grit can ruin the finish. Can be used for pre-polishing and high gloss polishing of small to medium even surfaces from non-ferrous metals to stainless steel.

**ONLY USE IN COMBINATION WITH POLISHING PASTES (SEE PAGES 132-134) OR POLISHING CREAM (SEE PAGE 134).**



**Technical Data:**

Dimensions (mm)	Material	Ideal speed (rpm)	Max. speed (rpm)	Pkg. unit	Article number
Ø 100 x 50 x 19	Merino felt	1,000 – 3,000	5,000	4	40017



Suitable for

**NON-FERROUS METALS**

# Cotton Ring (Impregnated)



Fine cotton rings for polishing. Impregnated version for non-ferrous metals. Do not use different pastes or creams on the same cotton ring. Ideal for high-gloss polishing of non-ferrous metals, such as aluminium and brass. Ideal for uneven workpieces and corrugated sheet metals. The spline shaft hole allows it to be slipped directly onto the POLY-PTX® 800 Professional. 8 pcs (1 pack) for 100 mm shaft. **ONLY USE IN COMBINATION WITH POLISHING PASTES (SEE PAGES 132-134) OR POLISHING CREAM (SEE PAGE 134).**

**Technical Data:**

Dimensions (mm)	Material	Ideal speed (rpm)	Max. speed (rpm)	Pkg. unit	Article number
Ø 100 x 10 x 19	Cotton (impregnated)	1,000 – 3,000	5,000	8	40019



Suitable for

**STAINLESS STEEL**

# Mirror Finishing Ring Medium



Fine polishing rings made from technical fleece, impregnated for stainless steel. Do not use different pastes or creams on the same mirror finishing ring. Used for the main polish of narrow and uneven stainless steel surfaces and corrugated sheet metals. The spline shaft hole allows it to be slipped directly onto the POLY-PTX® 800 Professional. 8 pces (1 pack) for 100 mm shaft.

**ONLY USE IN COMBINATION WITH POLISHING PASTES (SEE PAGES 132-134) OR POLISHING CREAM (SEE PAGE 134).**

## Technical Data:

Dimensions (mm)	Material	Ideal speed (rpm)	Max. speed (rpm)	Pkg. unit	Article number
Ø 100 x 10 x 19	Technical fleece (impregnated)	1,000 – 3,000	5,000	8	40019m



Suitable for

**STAINLESS STEEL · NON-FERROUS METALS**

# Mirror Finishing Ring Soft



Fine, soft polishing rings made from technical fleece. Do not use different pastes or creams on the same mirror finishing ring. Mirror finishing ring effect (final polish for stainless steel through to non-ferrous metals) – same result as using buff wheels. The spline shaft hole allows it to be slipped directly onto the POLY-PTX® 800 Professional. 8 pces (1 pack) for 100 mm shaft.

**ONLY USE IN COMBINATION WITH POLISHING PASTES (SEE PAGES 132-134) OR POLISHING CREAM (SEE PAGE 134).**

## Technical Data:

Dimensions (mm)	Material	Ideal speed (rpm)	Max. speed (rpm)	Pkg. unit	Article number
Ø 100 x 10 x 19	Technical fleece	1,000 – 3,000	5,000	8	40019t



Suitable for

**ALL METALS**

# BRIGHTEX® Polishing Paste

Berry + Sun

For the first time, the pre-polish and main polishing steps can be completed using just one BRIGHTEX® paste (Berry)! This has been made possible by a completely new formulation and as a result, it only takes a few moments to polish stainless steel to a mirror finish. The yellow BRIGHTEX® Sun paste creates an even brighter high gloss shine – almost as if it's chrome plated. Both pastes can be used on SuperPolish & Felt discs, belts and sleeves. The process is to apply the paste onto the disc while running at a low speed ensuring it is completely covered. This process can be repeated several times. The pastes can also be used in addition to the new BRIGHTEX® polishing system (impregnated polishing discs, belts and sleeves) to "top up" the polishing paste as required.



## FEATURES

- For reconditioning surfaces that are mirror-polished mechanically
- For use with felt, cotton and fleece discs, wheels, sleeves, belts, etc.
- Ideal for use with polishing machines and hand-held polishing tools (POLY-PTX®)
- For best results, use Eisenblätter care and cleaning products for removing polish residues
- Completely new high-tech paste formulation for all metals

### BRIGHTEX® Berry:

- For applying a rapid high-gloss polish to all metals
- Pre-polish and main polish in one – save on additional operations

### BRIGHTEX® Sun:

- A mirror shine that's almost as if chrome-plated – the perfect finish
- For a final high gloss shine on polished metals
- For removing any leftover clouding and smears on all metals

## Technical Data:

Paste	Contents (g)	Application	Pkg. unit	Article number
BRIGHTEX® Berry pre-polishing paste	Approx. 1.100	Super polish	1	40025
BRIGHTEX® Sun final-polishing paste	Approx. 1.300	Top finish	1	40026

Suitable for

**ALL METALS**

# BRIGHTEX<sup>®</sup> Softclean Powder

A new and much improved cleaning powder removes all cream and paste residues after every polish and allows all metals to shine completely scratch-free in their best light. Replaces POLY Lime for a significantly better effect! Apply a little using the shaker and wipe off without applying any pressure using a clean microfibre cloth. Powder consists of ultra-fine micro-particles with a large surface area for the best possible absorbency.



#### Technical Data:

Packaging	Contents (g)	Pkg. unit	Article number
Resealable bag	Approx. 1,000	1	40028
Aluminium shaker	Approx. 200	1	40029

Suitable for

**ALL MATERIALS**

# BRIGHTEX<sup>®</sup> Non-Scratch Cloth



Much improved, ultra-soft microfibre cloth, free of seams for scratch-free cleaning of stainless steel surfaces and other decorative metals. Particularly soft and absorbent. Can be washed many times.

#### Technical Data:

Dimensions (mm)	Quality	Pkg. unit	Article number
400 x 400	360 g/m <sup>2</sup>	5	40031



Suitable for

**ALL METALS**

# Polishing Paste

Mirror finish polish for all metals (including aluminium).  
White for the pre polish and blue for the final polish.



**Technical Data:**

Paste	Packaging	Contents (g)	Pkg. unit	Article number
White pre-polishing paste	Cardboard sleeve	Approx. 650	1	40013
Blue final-polishing paste	Cardboard sleeve	Approx. 650	1	40014
Mini pastes – white and blue	ZIP-LOCK bags	Approx. 120 (60 each)	1	40009

Suitable for

**ALL METALS**

# Pink Polishing Cream

For the final polish. Produces a flawless mirror finish on all metals when applied to SuperPolish, felt and polishing rings. Brings a quick shine – also suitable for manual application using polishing cloths, which is perfect for unusual shaped objects.



**Technical Data:**

Packaging	Contents	Pkg. unit	Article number
Can	Approx. 1000 g	1	40015
Mini-tube	Approx. 60 ml	1	40015f

Suitable for

**ALL METALS**

# Microfibre Cloth

These microfibre cloths have a lightning-fast pore-deep cleaning effect and evenly distributes cleaning products onto the surface. It can also remove paste and cream residues.



**Technical Data:**

Dimensions (mm)	Quality	Pkg. unit	Article number
400 x 400	290 g/m <sup>2</sup>	25	40030

Suitable for

**STEEL · STAINLESS STEEL · NON-FERROUS METALS · WOOD**

# POLY-PTX® Clean Wheel

Ultra-resistant nylon fleece cleaning wheel



Grit-impregnated coarse nylon fabric – fits on the normal 100mm shaft but has a working width of 110 mm due to the overhang. As a result, the tightening screw is sunk into the wheel and you can grind up to the edge. With a vibration-damping core for single, double and quadruple spline shafts, ensuring the wheel runs perfectly. Cleans and removes pore-deep paint, rust, scale and dirt on all materials. Similar effect to sand-blasting; as it cleans without removing material. Ideal for car bodywork, the automotive industry, in shipyards and renovation work by commercial decorators and builders.

### Technical Data:

Dimensions (mm)	Ideal speed (rpm)	Max. speed (rpm)	Pkg. unit	Article number
Ø 115 x 110 x 19	1,000 – 2,000	5,000	2	40018
Ø 115 x 50 x 19	1,000 – 2,000	5,000	4	40018a

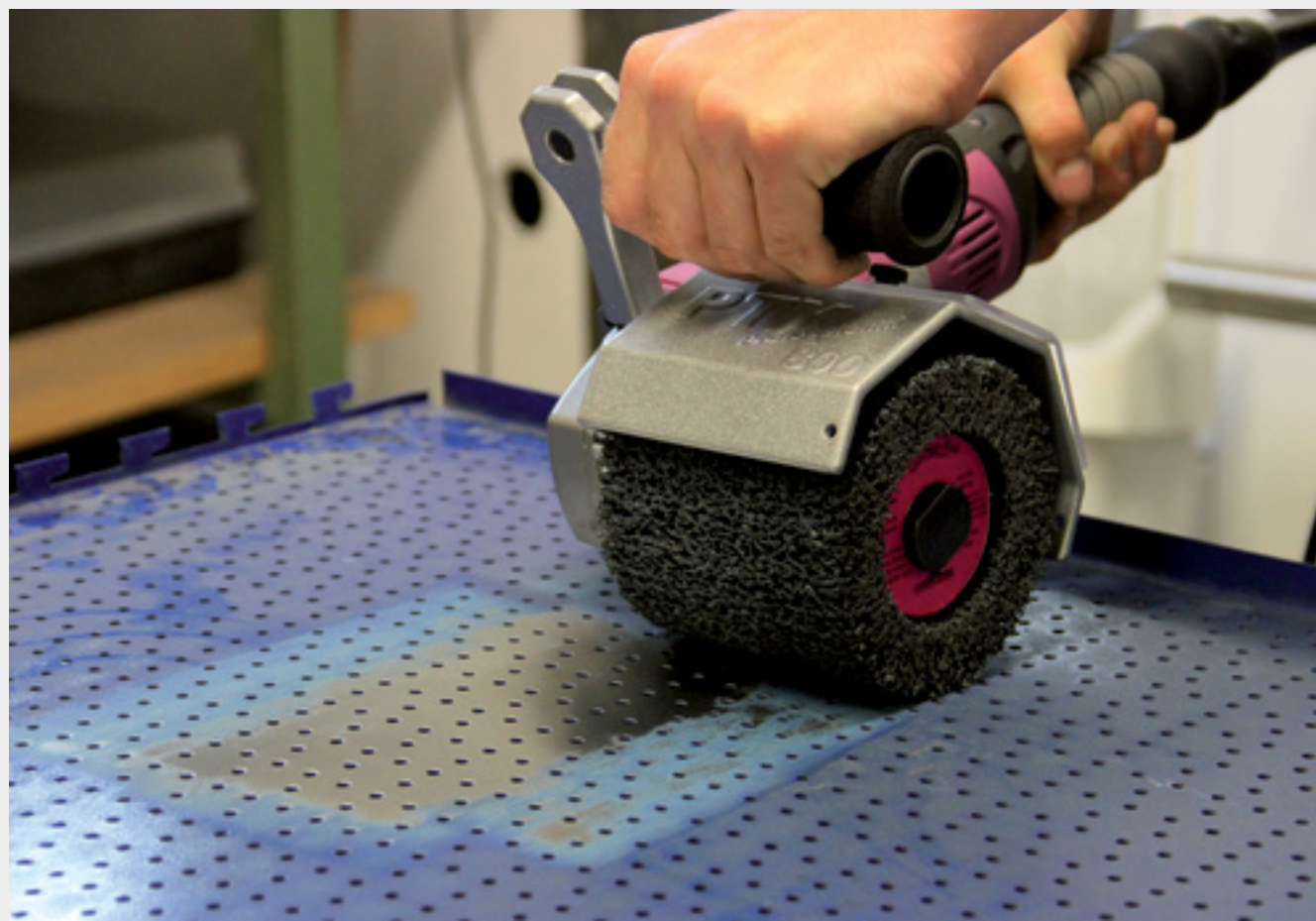

Suitable for

**STEEL · STAINLESS STEEL · NON-FERROUS METALS · WOOD**

## POLY-PTX<sup>®</sup> Clean Wheel Soft



Ultra-soft nylon fleece clean wheel

Cleans and removes pore-deep paint, rust, scale and dirt on all materials. Similar effect to sand-blasting; as it cleans without removing material. Ideal for car bodywork, the automotive industry, in shipyards and renovation work by commercial decorators and builders. Can also be used for a coarse satin finish (grit 60).

### Technical Data:

Dimensions (mm)	Ideal speed (rpm)	Max. speed (rpm)	Pkg. unit	Article number
Ø 115 x 100 x 19	1,000 – 2,000	5,000	2	40018w



Suitable for

**STEEL · WOOD**

# POLY-PTX® Wire Wheel

Rippled wire wheel for steel.

**Metal:** For removing rust, deburring, rough grinding and cleaning.

**Wood:** For brushing out soft growth rings on hardwoods and creating a rustic effect.



**Technical Data:**

Dimensions (mm)	Material	Wire thickness (mm)	Max. speed (rpm)	Pkg. unit	Article number
Ø 100 x 12 x 19	Steel	0.27	8,000	8	46302
Ø 100 x 25 x 19	Steel	0.27	8,000	4	46302n
Ø 100 x 70 x 19	Steel	0.27	8,000	1	46301



Suitable for

**STAINLESS STEEL**

# POLY-PTX® INOX Wire Wheel

Stainless steel brush for cleaning spot welds, deburring (rustproof), removing rust, rough grinding and removing lacquer, paint and impurities on stainless steel perforated sheets.



**Technical Data:**

Dimensions (mm)	Material	Wire thickness (mm)	Max. speed (rpm)	Pkg. unit	Article number
Ø 100 x 12 x 19	Stainless steel	0.2	8,000	8	46202
Ø 100 x 25 x 19	Stainless steel	0.2	8,000	4	46202n
Ø 100 x 70 x 19	Stainless steel	0.2	8,000	1	46201





Suitable for

**ALL METALS · WOOD**

## Bristle Wheel

Grit-impregnated plastic brush.

**Metal:** For rough grinding and deburring.

**Wood:** For creating rustic effects with soft growth ring transitions on soft woods.



### Technical Data:

Dimensions (mm)	Material	Max. speed (rpm)	Thickness of bristles (mm)	Pkg. unit	Article number
Ø 100 x 12 x 19	Grit-impregnated nylon	8,000	1.27	8	46102
Ø 100 x 25 x 19	Grit-impregnated nylon	8,000	1.27	4	46102n
Ø 100 x 70 x 19	Grit-impregnated nylon	8,000	1.27	1	46101



Suitable for

**WOOD**

## Fibre Wheel

Flexible fibre brush for polishing stained wood surfaces to create a matt sheen effect and for pore-deep dust removal and cleaning.



### Technical Data:

Dimensions (mm)	Material	Max. speed (rpm)	Thickness of bristles (mm)	Pkg. unit	Article number
Ø 100 x 100 x 19	Fibre	8,000	0.4	1	46400



### Working with wood:

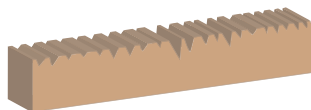

Used in combination with a wire wheel, the POLY-PTX® 800 is outstanding for brushing out soft growth rings in coniferous woods. A coarse rustic effect is easy to produce due to the materials used (wire brush for steel).

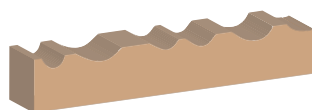

Used with the bristle wheel, a flexible, grit-impregnated plastic brush, the POLY-PTX® 800 is the ideal tool for producing a rustic effect with a soft growth ring transition.

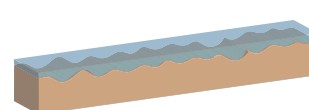

The fibre wheel guarantees stained wood surfaces are polished simply and yet with a top quality finish. The flexible fibre brush guarantees a perfect matt sheen effect and is ideal for pore-deep removal of dust and cleaning.

**Streak-free  
satin finish  
by hand!**



Suitable for

**LINEAR GRINDING · POLISHING**

## **POLY-PTX<sup>®</sup> 800 PROFESSIONAL**



From the inventor of the linear grinding machine. More powerful than the original. Our multipurpose linear grinder now with even more power. 1750-watt output, variable-speed, ergonomic design and extremely versatile – even for working widths of up to 150 mm. High torque and power reserves guarantee a long service life and improved economy.

### **FEATURES**

- Grinds from coarse to very fine
- Balanced, straight-line control without support rollers, allowing the tool to be freely adjusted (oscillation effect). Highly decorative surfaces are guaranteed in satin and matt finish and industrial grinding without shadows or transitions
- Produces a satin finish, polishes to a mirror finish and improves surface finish on stainless steel, steel, non-ferrous metals (e.g. brass, bronze, copper and aluminium) as well as wood
- Very fine grinding on large surface areas – with no shadows or streaks
- Perfect for use as a pipe grinder when using a grinding belt roller
- Removes spot welds, deep scratches, rust, dirt, paint and oxide layers
- Just three steps from coarse grinding to a mirror finish on stainless steel and non-ferrous metals
- Grinds and polishes open and closed pipe constructions
- A “T-lock system” for pipe grinding ensures safe, fast connection of fleece and felt belts to closed pipe constructions. No more hassle having to glue the belts
- Huge range of grinding tools to cover almost every conceivable job
- Now with a rubberised handle for excellent handling





## Technical Data: POLY-PTX® 800 PROFESSIONAL Machine

Type of plug	Cable type	Power (W)	Mains connection (V ~ Hz)	Speed (rpm)	Mount	Working width (mm)	Wheel diameter (mm)	Weight (g)	Pkg. unit	Article number
EU (C+F)	QUICK-LOCK	1,750	220 – 240 ~ 50 – 60	1,000 – 3,800	19 mm (double keyway) Optional: Eco Smart adapter	max. 100 (with Eco Smart 150)	max. 115	3,300	1	40002
CH (J)	QUICK-LOCK	1,750	220 – 240 ~ 50 – 60	1,000 – 3,800				3,300	1	40002s
US (B)	QUICK-LOCK	1,710	120	1,000 – 3,800				3,300	1	47002a
UK (G)	Permanent connection	1,600	110 ~ 50 – 60	1,000 – 3,800				3,300	1	40002a
JP (B)	Permanent connection	1,600	110 ~ 50 – 60	1,000 – 3,800				3,300	1	40002j

Accessories included in package: 1 POLY-PTX® 800 PROFESSIONAL machine, 1 x 4 m cable, 1 POLY-PTX® tightening screw, 1 fleece wheel 115 x 100 x 19 mm

Adjustable 5-position handle suitable for right and left-handed users – reduces strain on the user

Maintenance cover allows brushes to be changed quickly

Easy to control speed when operating; tacho-generator for constant speed even under load and fine adjustment for tool optimisation

Exclusive to Eisenblätter: rubberised handle for optimum and safe handling



Optional: Eco Smart adapter for roller widths of up to 150 mm and vibration-free operation

Infinitely adjustable swiveling protective cover with option to secure the extraction cover; infinitely adjustable, retractable, polycarbonate ancillary cover for grinding roller widths of up to 150 mm

QUICK-LOCK cable quick-release fastening for fast, easy replacement of damaged cables, for example



Suitable for

**COARSE GRINDING TO MIRROR FINISHING**

# POLY-PTX® 800 Professional Set

Coarse grinding to mirror finish



You'll always have the right tool to hand with a POLY-PTX® 800 professional set – in the workshop and on site. The set includes an additional Eco Smart adapter and comes in a practical, strong and impact-resistant carry case. It contains everything you need for a shadow-free industrial finish to a perfect mirror finish on metals (flat surfaces and pipes) as well as newly developed cleaning products and preservatives for optimum surface protection against marks and fingerprints.

**Technical Data:**

Plug type	Cable type	Power (W)	Mains connection (V ~ Hz)	Speed (rpm)	Mount	Working width (mm)	Roller diameter (mm)	Pkg. unit	Article number
EU (C+F)	QUICK-LOCK	1,750	220 – 240 ~ 50 – 60	1,000 – 3,800	19 mm (double keyway) Optional: Eco Smart adapter	Max. 100 (with Eco Smart 150)	Up to 115	1	40003-5
CH (J)	QUICK-LOCK	1,750	220 – 240 ~ 50 – 60	1,000 – 3,800				1	40003-5s
US (B)	QUICK-LOCK	1,710	120	1,000 – 3,800				1	47003-5a
UK (G)	Permanent connection	1,600	110 ~ 50 – 60	1,000 – 3,800				1	40003-5a
JP (B)	Permanent connection	1,600	110 ~ 50 – 60	1,000 – 3,800				1	40003-5j

**Contents of Set:**

- 1 POLY-PTX® 800 PROFESSIONAL machine
- 1 Professional Case
- 1 x 4 m cable
- 1 Spacer ring set
- 1 Eco Smart adapter
- 1 Mini-tube of high-gloss pink polishing cream
- 2 Mini polishing pastes (white and blue)
- 1 Shaker BRIGHTEX® Softclean powder
- 1 Spray bottle BRILLIANCE CLEAN 500 ml
- 1 Spray bottle INOX PROTECT 500 ml
- 2 Microfibre cloths

**Linear grinding:**

- 1 Expansion roller Ø 90 x 100 mm
- 2 Zirconium sleeves Ø 90 x 100 mm
- 1 SC fleece sleeve Ø 90 x 100 mm medium
- 1 SC fleece sleeve Ø 90 x 100 mm fine
- 2 Trizact™ sleeves Ø 90 x 100 mm A45
- 2 Trizact™ sleeves Ø 90 x 100 mm A30
- 2 Trizact™ sleeves Ø 90 x 100 mm A16
- 2 Trizact™ sleeves Ø 90 x 100 mm A06
- 3 SuperPolish sleeves Ø 90 x 100 mm
- 1 Flap wheel Ø 105 x 100 mm
- 1 Fleece wheel Ø 105 x 100 mm
- 8 Top Finish rings Ø 100 x 12 mm soft

**Pipe grinding:**

- 1 Grinding belt roller with stainless steel flanges
- 2 Grinding belts 30 x 600 mm
- 1 SC fleece belt Ø 30 x 660 mm medium
- 2 Trizact™ belts Ø 30 x 600 mm A45
- 2 Trizact™ belts Ø 30 x 600 mm A30
- 2 Trizact™ belts Ø 30 x 600 mm A16
- 2 Trizact™ belts Ø 30 x 600 mm A06
- 3 SuperPolish belts Ø 30 x 650 mm

Suitable for

**COARSE TO FINE GRINDING**

# POLY-PTX<sup>®</sup> 800 Metal Set



Complete solutions for a wide range of jobs

You'll always have the right tool to hand with a POLY-PTX<sup>®</sup> 800 metal set – in the workshop and on site. The ideal entry set for coarse to fine metal finishes. Ready for most standard sheet metal and pipe machining jobs and includes a large number of accessories.

### Technical Data:

Plug type	Cable type	Power (W)	Mains connection (V ~ Hz)	Speed (rpm)	Mount	Working width (mm)	Roller diameter (mm)	Pkg. unit	Article number
EU (C+F)	QUICK-LOCK	1,750	220 – 240 ~ 50 – 60	1,000 – 3,800	19 mm (double keyway) Optional: Eco Smart adapter	Max. 100 (with Eco Smart 150)	Up to 115	1	40003
CH (J)	QUICK-LOCK	1,750	220 – 240 ~ 50 – 60	1,000 – 3,800				1	40003s
US (B)	QUICK-LOCK	1,710	120	1,000 – 3,800				1	47003a
UK (G)	Permanent connection	1,600	110 – 50 – 60	1,000 – 3,800				1	40003a
JP (B)	Permanent connection	1,600	110 – 50 – 60	1,000 – 3,800				1	40003j

### Contents of Set:

- 1 POLY-PTX<sup>®</sup> 800 PROFESSIONAL machine
- 1 x 4 m cable
- 1 Eco Smart adapter
- 1 Spacer ring set
- 1 INOX PROTECT 50 ml
- 1 BRILLIANCE CLEAN 50 ml

#### Linear grinding:

- 1 Expansion roller Ø 90 x 100 mm
- 2 Zirconium sleeves Ø 90 x 100 mm
- 1 SC fleece sleeve Ø 90 x 100 mm medium
- 1 SC fleece sleeve Ø 90 x 100 mm fine
- 2 Flap wheels Ø 105 x 50 mm
- 1 Mix wheel Ø 105 x 100 mm
- 1 Fleece wheel Ø 105 x 100 mm
- 1 Fleece wheel Ø 105 x 150 mm

#### Pipe grinding:

- 1 Grinding belt roller with stainless steel flanges
- 2 Grinding belts 30 x 600 mm
- 1 SC fleece belt Ø 30 x 660 mm medium

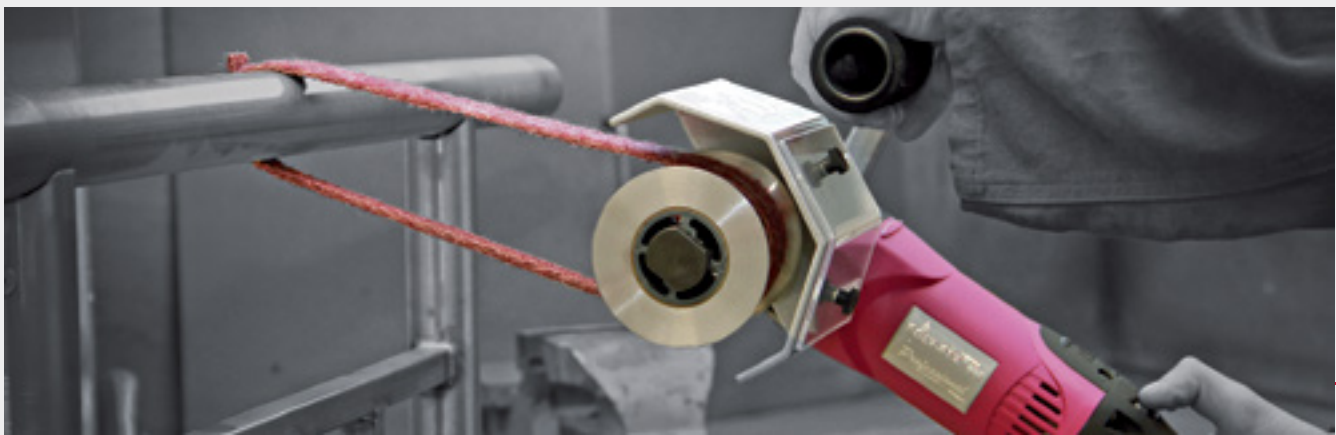

Suitable for

**WOOD**

# POLY-PTX® 800 Wood Set



Complete solutions for a wide range of jobs

You'll always have the right tool on hand with the POLY-PTX® 800 wood set. This set includes an additional Eco Smart adapter and contains everything you need for a brushed and rustic effect on wood surfaces and for polishing wax stains.

**Technical Data:**

Plug type	Cable type	Power (W)	Mains connection (V ~ Hz)	Speed (rpm)	Mount	Working width (mm)	Roller diameter (mm)	Pkg. unit	Article number
EU (C+F)	QUICK-LOCK	1,750	220 – 240 ~ 50 – 60	1,000 – 3,800	19 mm (double keyway) Optional: Eco Smart adapter	Max. 100 (with Eco Smart 150)	Up to 115	1	40004
CH (J)	QUICK-LOCK	1,750	220 – 240 ~ 50 – 60	1,000 – 3,800				1	40004s
US (B)	QUICK-LOCK	1,710	120	1,000 – 3,800				1	47004a
UK (G)	Permanent connection	1,600	110 ~ 50 – 60	1,000 – 3,800				1	40004a
JP (B)	Permanent connection	1,600	110 ~ 50 – 60	1,000 – 3,800				1	40004j

**Contents of Set:**

- 1 POLY-PTX® 800 PROFESSIONAL machine
- 1 x 4 m cable
- 1 Suction cover for dust intake
- 1 Spacer ring set
- 1 Eco Smart adapter
- 1 Eco Smart mix wheel Ø 105 x 100 mm
- 1 Bristle wheel Ø 100 x 70 mm
- 1 Bristle wheel Ø 100 x 25 mm
- 1 Bristle wheel Ø 100 x 12 mm
- 1 Wire wheel Ø 100 x 70 mm
- 1 Wire wheel Ø 100 x 25 mm
- 1 Wire wheel Ø 100 x 12 mm
- 1 Fibre wheel Ø 100 x 100 mm



**Working with wood:**

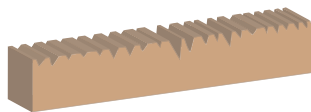

Used in combination with a stranded wire wheel, the POLY-PTX® 800 is outstanding for brushing out soft growth rings in coniferous woods. A coarse rustic effect is easy to produce due to the materials used (wire brush for steel).

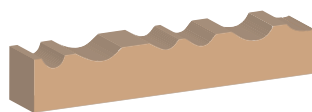

Used with the bristle wheel, a flexible, grit-impregnated plastic brush, the POLY-PTX® 800 is the ideal tool for producing a rustic effect with a soft growth ring transition.

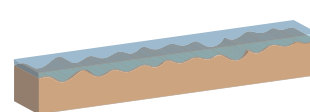

The fibre wheel guarantees stained wood surfaces are polished simply and yet with a top quality finish. The flexible fibre brush guarantees a perfect matt sheen effect and is ideal for pore-deep removal of dust and cleaning.

Suitable for

**SLEEVES Ø 90 mm**

# POLY-PTX<sup>®</sup> Expansion Roller



The patented triple-segment expansion roller is a special innovation. Improves all grinding and polishing results due to the optimum adjustment to the workpiece. Changing the sleeve is particularly easy with the patented triple segment system.

### Technical Data:

Dimensions (mm)	Max. speed (rpm)	Pkg. unit	Article number
Ø 90 x 100 x 19	5,000	1	42002
Ø 90 x 50 x 19	5,000	1	42001



Suitable for

**SLEEVES Ø 90 x 100 mm**

# POLY-PTX<sup>®</sup> Inflatable Expansion Roller



This inflatable roller is recommended for the individual "hardness adjustment" of the respective zirconium, ceramic, SC fleece, Trizact™, SuperPolish, BRIGHTEX<sup>®</sup> and felt sleeves. It is particularly suitable for grinding flat surfaces and edges. Can also be inflated using a bicycle pump (adapter included).

### Technical Data:

Dimensions (mm)	Max. speed (rpm)	Pkg. unit	Article number
Ø 90 x 100 x 19	5,000	1	42003





Suitable for

**BELTS UP TO 30 mm IN WIDTH**

# POLY-PTX<sup>®</sup> Grinding Belt Roller

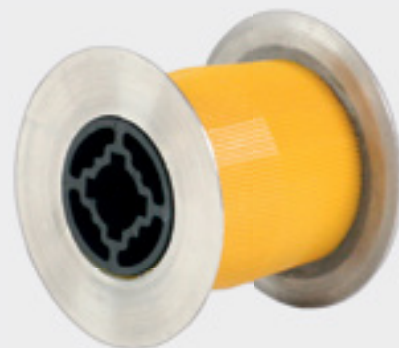

**Belts up to 30mm wide.** Grinding belt roller made from wear-resistant, soft, fluted Vulculan plastic for a better grip and with stainless steel flanges. With a vibration-damping core for single, double and quadruple spline shafts, ensuring the roller runs perfectly.

**FOR SUITABLE BELTS, SEE PAGE 156 ONWARDS.**

### Technical Data:

Dimensions (mm)	Material	Max. speed (rpm)	Pkg. unit	Article number
Ø 85 x 70 x 19	Vulculan polyurethane with stainless steel flanges	5,000	1	40006va



Suitable for

**ECO SMART TOOLS**

# POLY-PTX<sup>®</sup> Eco Smart Adapter

Complete solutions for a wide range of jobs

The innovative, low-cost system for linear grinding with the fastest tool change. Simply slide the tool onto the Eco Smart adapter – they attach automatically when the machine is running. It improves all grinding and polishing results due to the optimum adjustment of the workpiece.



**FEATURES**

- Can be used for POLY-PTX<sup>®</sup> and all linear grinding machines with a 19 mm diameter spline shaft
- Newly developed tool mount for lightning fast tool change
- Guarantees an immediate and secure hold on the tools once attached
- Finned rigid rubber sleeve that provides for completely vibration-free grinding and ensures the tools run perfectly
- A selection of roller tools for the POLY-PTX<sup>®</sup>. The tools are lighter as there is no core – a huge advantage when using and transporting the tools
- Adapter for using Eco Smart tools with the POLY-PTX<sup>®</sup> 800 PROFESSIONAL or with other linear grinding machines with a 19 mm diameter spline shaft. Simply slide the adapter onto the spline shaft and you're ready to use the low-cost range of Eco Smart tools

**Technical Data:**

Dimensions (mm)	Max. speed (rpm)	Pkg. unit	Article number
Ø 45 x 100 x 19	6,000	1	42004



Simply attach the Eco Smart adapter onto the linear grinding machine's 19 mm spline shaft to start using the low-cost range of Eco Smart tools. The improved tolerance compensation bar has now made the adapter even more effective to use. All Eco Smart wheels are secured in seconds and without tools due to the counter-rotating rubber flaps.



Suitable for

**SLEEVES Ø 90 x 100 mm**

# POLY-PTX<sup>®</sup> Eco Smart Expansion Roller



The patented triple-segment expansion roller is a special innovation. Improves all grinding and polishing results due to the optimum adjustment of the workpiece. Changing the sleeve is particularly easy with the patented triple segment system. Simply attach the Eco Smart adapter onto the linear grinding machine's 19 mm spline shaft to mount the Eco Smart expansion roller without tools.

### Technical Data:

Dimensions (mm)	Max. speed (rpm)	Pkg. unit	Article number
Ø 90 x 100 x 45	5,000	1	47005

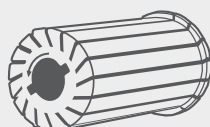

Suitable for

**BELTS UP TO 30 mm WIDTH**

# POLY-PTX<sup>®</sup> Eco Smart Grinding Belt Roller



Return roller made from wear-resistant, soft, fluted Vulculan plastic for a better grip and used with POLY-PTX<sup>®</sup> Eco Smart adapter.

**FOR SUITABLE BELTS, SEE PAGE 156 ONWARDS.**

### Technical Data:

Dimensions (mm)	Material	Max. speed (rpm)	Pkg. unit	Article number
Ø 85 x 70 x 45	Vulculan polyurethane with stainless steel flanges	5,000	1	47006



### QUICK-LOCK Cable

Suitable for VARILEX® WSF 900, 1600 & 1800, POLY-PTX® 300, 500 & 800 PROFESSIONAL, ROLEI EF 115, PIPE MAX, PIPE SNIPER® and GLADIUS® 1800.

**Technical Data:**

Version	Cable length (m)	Voltage (V)	Pkg. unit	Article number
EU (C+F)	4	220 – 240	1	52004-3
EU (C+F)	10	220 – 240	1	52005-3
CH (J)	4	220 – 240	1	52004-3s
AU	4	220 – 240	1	52004-3a
UK (G)	4	110	1	52004-3e
US (B)	4	120	1	52004-3u
Plug adapter – EU to UK	4		1	52004d



### Aluminium Suction Cover

The aluminium suction cover encloses the POLY-PTX® 800 protective cover on the side. For all commonly available industrial extractors. With the new parallel hose guide, workpieces can be machined into the corners. Ideal for jobs that generate a great deal of dust (e.g. machining aluminium and wood).

Can be used with rollers of up to 100 mm in width; supplied with fixing bolts.

**Technical Data:**

Suction flange internal diameter (Ø mm)	Suction flange external diameter (Ø mm)	Material	Pkg. unit	Article number
35	40	Aluminium, powder-coated	1	40005





## Special Handle Bar

Top quality handle made from aluminium with rubberised-foam coating to improve handling when working with the POLY-PTX® 800. Can also be used with earlier models, POLY-PTX® 300 and 500. Also ideal for working overhead and horizontal grinding positions. Supplied with fixing bolts.

### Technical Data:

Material	Pkg. unit	Article number
Aluminium	1	40080

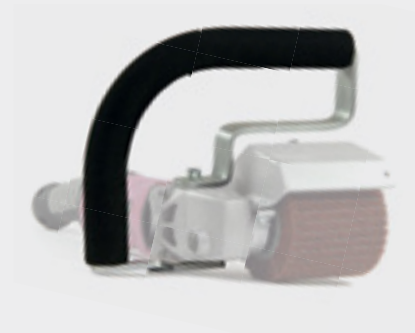

## Spacer Ring Set

For adjusting the width on 19 mm double spline shafts for brushes, rollers, polishing rings, etc. Contents: 2 pcs 20 mm width, 1 pce 10 mm width and 1 pce 50 mm width

### Technical Data:

Material	Pkg. unit	Article number
Rigid plastic	1	40007

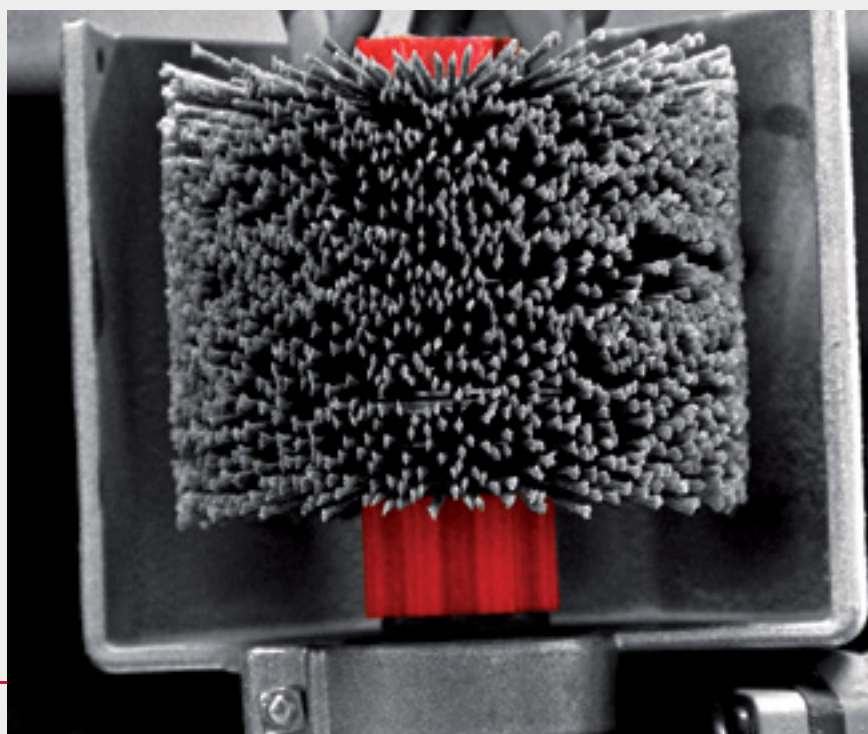

Suitable for

**TRIZACT™ -GRINDING BELTS - 30 X 600 mm**

# POLY-PTX® Special Adhesive Tape



Heat-resistant adhesive tape with linear reinforcement for a tear-resistant hold on open and resealed grinding belts. For resealing high quality corundum and Trizact™ belts for working on closed pipe systems with a grinding belt roller. Perfect for extended use on pipes with the POLY-PTX® 800 and VARILEX® WSF 900 DUO.

**Technical Data:**

Width (mm)	Length (m)	Pkg. unit	Article number
25	50	1	49000

Closed grinding belts, such as the grinding belt or Trizact™ belt, are cut open for working on closed pipe constructions, placed across the pipe and taped around in an overlapping pattern across the entire length (approx. 370°) using our specially developed adhesive tape.



Suitable for

**PERFECT MITER GRINDING**

## Stainless Steel Cover Plate

Stainless steel (1.4301 / 304) produces precision mitered edges and is easy to cut. Self-adhesive for fast application and can be removed without leaving any residue. Clean adhesion for perfect miter grinding on all materials.



**SEE PAGE 218 FOR MORE DETAILS.**





**Pipe grinding  
made easy!**



# BELT GRINDING

## BELT GRINDING ..... 154

Application Overview..... 154

## GRINDING AND BLENDING ..... 155

Special HellFire® Belt ..... 155

Special Zirconium Belt ..... 155

Corundum Grinding Belt ..... 156

Corundum Grinding Sleeve ..... 157

## FINISHING AND FINE GRINDING ..... 158

Trizact™ Belt ..... 158

SC Fleece Belt ..... 159

SC Fleece Belt (T-lock) ..... 160

Trizact™ Sleeve ..... 161

SC Fleece Sleeve ..... 162

## POLISHING ..... 163

BRIGHTEX® Polishing Belt ..... 163

SuperPolish Belt ..... 164

Felt Belt (T-lock) ..... 165

Felt Belt ..... 165

Felt Sleeve ..... 166

SuperPolish Sleeve ..... 166

BRIGHTEX® Polishing Paste ..... 167

BRIGHTEX® Softclean Powder ..... 168

BRIGHTEX® Non-Scratch Cloth ..... 168

Polishing Paste ..... 169

Pink Polishing Cream ..... 169

Microfibre Cloth..... 169

## POWER TOOLS ..... 170

PIPE MAX ..... 170

PIPE MAX Metal Set ..... 172

QUICK-LOCK Cable ..... 173

PIPE FIX DUO ..... 174

PIPE FIX DUO Metal Set ..... 176

PIPE FIX DUO Belt Filing Accessory Pack ..... 177

PIPE FIX DUO Flat Filing Attachment..... 177

PIPE FIX SMART ..... 178

PIPE FIX Smart Metal Set ..... 180

PIPE SNIPER® ..... 182

PIPE SNIPER® Metal Set ..... 184

The EISENBLÄTTER Demo Bus ..... 185

GLADIUS® 1800 ..... 186

GLADIUS® 1800 Metal Set ..... 188

QUICK-LOCK Cable ..... 189

GLADIUS® 1800 Machine Stand ..... 189



# Application Overview

## PIPE FIX DUO

Belt dimensions:  
60 x 260 mm  
**Page 174**

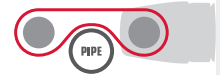
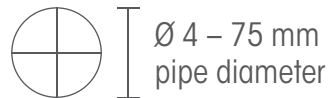

## PIPE FIX SMART

Belt dimensions:  
9 x 533 mm  
**Page 178**

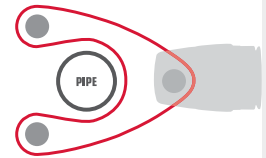
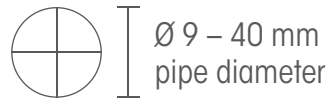

## PIPE SNIPER®

Belt dimensions:  
40 x 780 mm  
**Page 182**

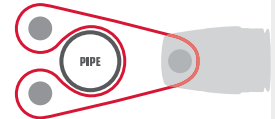
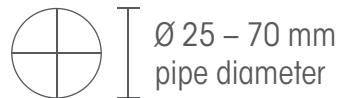

## PIPE MAX

Belt dimensions:  
40 x 780 mm  
**Page 170**

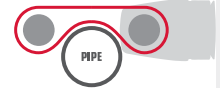

## POLY-PTX® 800 PROFESSIONAL

Belt dimensions:  
30 x 600 mm  
30 x 660 mm (T-lock)  
**Page 140**

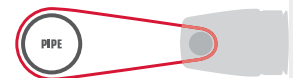

## VARILEX® WSF 900 DUO

Belt dimensions:  
30 x 600 mm  
30 x 660 mm (T-lock)  
**Page 74**

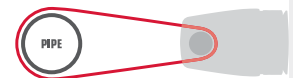

## GLADIUS® 1800

Belt dimensions:  
40 x 780 mm  
**Page 186**



Suitable for

**ALL METALS**

# Special HellFire® Belt

**For use with: PIPE MAX - GLADIUS® 1800**

Ceramic hybrid grinding belt with the same multigrain abrasive cloth (40/60 grit) as the multi-awardwinning flap disc, TRIMFIX® HellFire®. Just one grit for all jobs from coarse to medium grinding on hard-to-grind metals.

**Technical Data:**

Dimensions (mm)	Material	Pkg. unit	Grit (K)	Article number
40 x 780	Ceramic hybrid fabric	10	Multigrain 40/60	38520



Suitable for

**STEEL · STAINLESS STEEL**

# Special Zirconium Belt

**For use with: PIPE MAX · PIPE SNIPER® · GLADIUS® 1800**

Top quality grinding belt made from zirconium with cooling agents for grinding spot welds, eliminating deep scratches, rust, scale and for coarse industrial grinding. Prevents discolouration.

**Technical Data:**

Dimensions (mm)	Material	Pkg. unit	Grit (K)	Article number
40 x 780	Zirconium corundum with active cooling agent	10	40	38524
			60	38526
			80	38528
			120	38529



Suitable for

**STEEL · STAINLESS STEEL**

## Corundum Grinding Belt

Flexible grinding belt made from high quality corundum for a wide range of grinding jobs even with a small circumference. For coarse grinding, pre-grinding, removing scale, rust and smoothing round pipes.

**For use with: POLY-PTX® - VARILEX® WSF 900 Duo**

**ONLY TO BE USED IN COMBINATION WITH A GRINDING BELT ROLLER**

**(POLY-PTX® ON PAGES 146-148 AND VARILEX® WSF 900 DUO ON PAGE 78).**



### Technical Data:

Dimensions (mm)	Material	Pkg. unit	Grit (K)	Article number
30 x 600	High quality corundum	10	40	49040
			60	49060
			80	49080
			120	49120
			150	49150
			180	49180
			240	49240

Note: For special adhesive tape for re-sealing, see page 151.

**For use with: PIPE FIX DUO (Narrow Belt) / PIPE FIX SMART**



### Technical Data:

Dimensions (mm)	Material	Pkg. unit	Grit (K)	Article number
9 x 533	High quality corundum	10	40	49024
			60	49026
			80	49028
			120	49029
5 x 533	High quality corundum	10	40	49504
			60	49506
			80	49508
			120	49509
3 x 533	High quality corundum	10	40	49514
			60	49516
			80	49518
			120	49519



Suitable for

**STEEL · STAINLESS STEEL**

# Corundum Grinding Sleeve



## For use with: PIPE FIX DUO

Wide belt made from high quality corundum for a wide range of grinding applications. For reducing spot welds, removing with deep scratches, rust, scale and for coarse industrial grinding.

### Technical Data:

Dimensions (mm)	Material	Pkg. unit	Grit (K)	Article number
60 x 260	High quality corundum	10	60	38126
			80	38128
			120	38129





Suitable for

**STEEL · STAINLESS STEEL**

## Trizact™ Belt



Ideal for removing scratches and for pre-polishing for a mirror finish

New type of abrasive cloth with pyramid-shaped grit structure. Saves on several operating steps and has a high rate of material removal with a fine finish. Great for removing scratches and spot welds. Ideal for pre-polishing into subsequent mirror finish polishing. Leaves only minor surface roughness behind.

**For use with: POLY-PTX® · VARILEX® WSF 900 DUO**

**ONLY TO BE USED IN COMBINATION WITH A GRINDING BELT ROLLER (POLY-PTX® ON PAGES 146-148 AND VARILEX® WSF 900 DUO ON PAGE 78).**

Dimensions (mm)	Material	Pkg. unit	Grit (Trizact™)	Grit (K)	Removes material like	Article number
30 x 600	New type of grit structure (pyramid-shaped)	10	A100	220	36	49370
			A65	280	40	49365
			A45	400	50	49345
			A30	600	60	49330
			A16	1200	80	49316
			A06	2000	120	49306

Note: For special adhesive tape for re-sealing, see page 151.

**For use with: PIPE MAX · PIPE SNIPER® · GLADIUS® 1800**

Dimensions (mm)	Material	Pkg. unit	Grit (Trizact™)	Grit size (K)	Removes material like	Article number
40 x 780	New type of grit structure (pyramid-shaped)	10	A100	220	36	38544
			A65	280	40	38545
			A45	400	50	38546
			A30	600	60	38547
			A16	1200	80	38548

**For use with: PIPE FIX DUO · PIPE FIX SMART**

Dimensions (mm)	Material	Pkg. unit	Grit (Trizact™)	Grit (K)	Removes material like	Article number
9 x 533	New type of grit structure (pyramid-shaped)	10	A100	220	36	49034
			A65	280	40	49035
			A45	400	50	49036
			A30	600	60	49037
			A16	1200	80	49038
			A06	2000	120	49039



Suitable for

**STEEL · STAINLESS STEEL · NON-FERROUS METALS · WOOD · HARD PLASTICS**

## SC Fleece Belt

Technical surface conditioning fleece belt for removing minor scratches and oxide layers, grinding, matt and satin finish and deburring surfaces on pipe constructions and handrails.



**For use with: PIPE MAX · PIPE SNIPER® · GLADIUS® 1800**

Dimensions (mm)	Material	Pkg. unit	Grit (K)	Colour (Fleece)	Grit (Fleece)	Article number
40 x 780	Impregnated, grit-infused nylon fleece with reinforcing fabric	4	80	Brown	Coarse	38531
			180	Red	Medium	38532
			280	Blue	Fine	38533
			400	Grey	Superfine	38534



**For use with: PIPE FIX DUO (Narrow Belt) / PIPE FIX SMART**

Dimensions (mm)	Material	Pkg. unit	Grit (K)	Colour (Fleece)	Grit (Fleece)	Article number
9 x 533	Impregnated, grit-infused nylon fleece with reinforcing fabric	10	180	Red	Medium	49011s
			280	Blue	Fine	49012s



Suitable for

**STEEL · STAINLESS STEEL · NON-FERROUS METALS · WOOD · HARD PLASTICS**

## SC Fleece Belt (T-lock)



For use with: **POLY-PTX® 800 PROFESSIONAL · VARILEX® WSF 900 DUO**

Technical surface conditioning fleece belt with patented T-lock (re-sealable).

For removing minor scratches and oxide layers, matt and satin finish and deburring "closed" pipe constructions and handrails.

**ONLY TO BE USED IN COMBINATION WITH A GRINDING BELT ROLLER (POLY-PTX® ON PAGES 146-148 AND VARILEX® WSF 900 DUO ON PAGE 78).**

### Technical Data:

Dimensions (mm)	Material	Pkg. unit	Grit (K)	Colour (Fleece)	Grit (Fleece)	Article number
30 x 660	Impregnated, grit-infused nylon fleece with reinforcing fabric	5	80	Brown	Coarse	49001
			180	Red	Medium	49002
			280	Blue	Fine	49003
			400	Grey	Superfine	49007

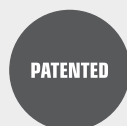

Suitable for

**STEEL · STAINLESS STEEL**

## Trizact™ Sleeve

### For use with: PIPE FIX Duo

New type of abrasive cloth with pyramid-shaped grit structure. Saves on several operating steps and has a high rate of material removal with a fine finish. Great for removing scratches and spot welds. Ideal for pre-polishing into subsequent mirror finish polishing. Leaves only minor surface roughness behind.



### Technical Data:

Dimensions (mm)	Material	Pkg. unit	Grit (Trizact™)	Grit (K)	Removes material like	Article number
60 x 260	New type of grit structure (pyramid-shaped)	10	A100	220	36	38270
			A65	280	40	38265
			A45	400	50	38245
			A30	600	60	38230
			A16	1,200	80	38216
			A06	2,000	120	38206





Suitable for

**STEEL · STAINLESS STEEL · NON-FERROUS METALS · WOOD · HARD PLASTICS**

## SC Fleece Sleeve

**For use with: PIPE FIX Duo**

Technical surface conditioning fleece sleeve for removing minor scratches and oxide layers, matt and satin finish and deburring surfaces on pipe constructions and handrails.



### Technical Data:

Dimensions (mm)	Material	Pkg. unit	Grit (K)	Colour (Fleece)	Grit (Fleece)	Article number
60 x 260	Impregnated, grit-infused nylon fleece with reinforcing fabric	4	180	Red	Medium	38111
			280	Blue	Fine	38112
			400	Grey	Superfine	38113



Suitable for

**ALL METALS**

# BRIGHTEX® Polishing Belt



Polishing material that is already impregnated with BRIGHTEX® polishing paste removes the hassle and time-consuming business of applying pastes and creams and gives untreated metal a shadow-free mirror finish. For immediate use without the need for additional pastes and creams!

## FEATURES

- For reconditioning surfaces that are mirror-polished mechanically
- For use with felt, cotton and fleece discs, wheels, sleeves, belts, etc.
- Ideal for use with polishing machines and hand-held polishing tools
- For best results, use Eisenblätter care and cleaning products for removing polish residues
- Completely new high-tech paste formulation for all metals

### BRIGHTEX® Berry:

- For applying a rapid high-gloss polish to all metals
- Pre-polish and main polish in one – saves additional working steps

### BRIGHTEX® Sun:

- A mirror shine that's almost as if chrome-plated – the perfect finish
- For a final high gloss shine on polished metals
- For removing any leftover clouding and smears on all metals

**For use with: POLY-PTX® - VARILEX® WSF 900 DUO**

**ONLY TO BE USED IN COMBINATION WITH A GRINDING BELT ROLLER (POLY-PTX® ON PAGES 146-148 AND VARILEX® WSF 900 DUO ON PAGE 78).**

Version	Dimensions (mm)	Material thickness (mm)	Application	Pkg. unit	Article number
Berry	30 x 650	5	Super polish	4	49005
Sun	30 x 650	5	Top finish	4	49006

**For use with: PIPE MAX - PIPE SNIPER® - GLADIUS® 1800**

Version	Dimensions (mm)	Material thickness (mm)	Application	Pkg. unit	Article number
Berry	40 x 780	5	Super polish	4	38551
Sun	40 x 780	5	Top finish	4	38552



Suitable for

**ALL METALS**

## SuperPolish Belt



Revolutionary special fleece. Used with polishing pastes and creams for a shiny mirror finish on stainless steel and non-ferrous metals which leaves no smears or shadows. Always use a separate SuperPolish belt for each paste and cream as it is important to not mix different grit sizes.

**ONLY USE IN COMBINATION WITH POLISHING PASTES (SEE PAGES 167-169) OR POLISHING CREAM (SEE PAGE 169).**

**For use with: POLY-PTX® - VARILEX® WSF 900 DUO**

**ONLY TO BE USED IN COMBINATION WITH A GRINDING BELT ROLLER (POLY-PTX® ON PAGES 146-148 AND VARILEX® WSF 900 DUO ON PAGE 78).**

Dimensions (mm)	Material thickness (mm)	Material	Pkg. unit	Article number
30 x 650	5	Polishing fleece	5	49004n

**For use with: PIPE MAX - PIPE SNIPER® - GLADIUS® 1800**

Dimensions (mm)	Material thickness (mm)	Material	Pkg. unit	Article number
40 x 780	5	Polishing fleece	4	38550



Suitable for

**STAINLESS STEEL · NON-FERROUS METALS · HARD PLASTICS**

# Felt Belt (T-lock)



**For use with: POLY-PTX® 800 · VARILEX® WSF 900 DUO**

First-class merino felt belt with patented T-lock (re-fasten able) – both sides can be used. For a rapid mirror finish polish for "closed" pipe constructions and handrails made from non-ferrous metals through to stainless steel, also suitable for hard plastic. Note: Do not use different pastes or creams on the same felt belt.

**ONLY USE IN COMBINATION WITH POLISHING PASTES (SEE PAGES 167-169) OR POLISHING CREAM (SEE PAGE 169).**

**ONLY TO BE USED IN COMBINATION WITH A GRINDING BELT ROLLER (POLY-PTX® ON PAGES 146-148 AND VARILEX® WSF 900 DUO ON PAGE 78).**

**Technical Data:**

Dimensions (mm)	Material thickness (mm)	Material	Pkg. unit	Article number
30 x 660	5	Merino felt	5	49004



Suitable for

**STAINLESS STEEL · NON-FERROUS METALS · HARD PLASTICS**

# Felt Belt



**For use with: PIPE FIX DUO (NARROW BELT) / PIPE FIX SMART**

Closed merino felt belts for main polish right through to a mirror finish on stainless steel and non-ferrous metals. Also suitable for hard plastic.

Note: Do not use different pastes or creams on the same felt belt.

**ONLY USE IN COMBINATION WITH POLISHING PASTES (SEE PAGES 167-169) OR POLISHING CREAM (SEE PAGE 169).**

**ONLY TO BE USED IN COMBINATION WITH A GRINDING BELT ROLLER (POLY-PTX® ON PAGES 146-148 AND VARILEX® WSF 900 DUO ON PAGE 78).**

**Technical Data:**

Dimensions (mm)	Material thickness (mm)	Material	Pkg. unit	Article number
9 x 533	5	Merino felt	10	49015





Suitable for

**STAINLESS STEEL · NON-FERROUS METALS · HARD PLASTICS**

# Felt Sleeve

**For use with: PIPE FIX DUO**

First-rate merino felt sleeve, continuous throughout with no joins. For a rapid mirror finish using polishing pastes and creams and no scratches or smears. Always use a separate felt for each paste and cream as it is important to not mix different grit sizes.

**ONLY IN COMBINATION WITH AN EXPANSION ROLLER – SEE PAGES 145-148.**

**ONLY USE IN COMBINATION WITH POLISHING PASTES (SEE PAGES 167-169) OR POLISHING CREAM (SEE PAGE 169).**



**Technical Data:**

Dimensions (mm)	Material thickness (mm)	Material	Pkg. unit	Article number
60 x 260	5	Merino felt	4	38114



Suitable for

**ALL METALS**

# SuperPolish Sleeve

**For use with: PIPE FIX DUO**

Revolutionary special fleece. Used with polishing pastes and creams for a shiny mirror finish on stainless steel and non-ferrous metals which leaves no smears or shadows. Always use a separate SuperPolish sleeve for each paste and cream as it is important to not mix different grit sizes.

**ONLY IN COMBINATION WITH AN EXPANSION ROLLER – SEE PAGES 145-148.**

**ONLY USE IN COMBINATION WITH POLISHING PASTES (SEE PAGES 167-169) OR POLISHING CREAM (SEE PAGE 169).**



**Technical Data:**

Dimensions (mm)	Material thickness (mm)	Material	Pkg. unit	Article number
60 x 260	5	Polishing fleece	4	38114n



Suitable for

**ALL METALS**

# BRIGHTEX® Polishing Paste

Berry + Sun

For the first time, the pre-polish and main polishing steps can be completed using just one BRIGHTEX® paste (Berry)! This has been made possible by a completely new formulation and as a result, it only takes a few moments to polish stainless steel to a mirror finish. The yellow BRIGHTEX® Sun paste creates an even brighter high gloss shine – almost as if it's chrome plated. Both pastes can be used on SuperPolish & Felt discs, belts and sleeves. The process is to apply the paste onto the disc while running at a low speed ensuring it is completely covered. This process can be repeated several times. The pastes can also be used in addition to the new BRIGHTEX® polishing system (impregnated polishing discs, belts and sleeves) to "top up" the polishing paste as required.



## FEATURES

- For reconditioning surfaces that are mirror-polished mechanically
- For use with felt, cotton and fleece discs, wheels, sleeves, belts, etc.
- Ideal for use with polishing machines and hand-held polishing tools (POLY-PTX®)
- For best results, use Eisenblätter care and cleaning products for removing polish residues
- Completely new high-tech paste formulation for all metals

### BRIGHTEX® Berry:

- For applying a rapid high-gloss polish to all metals
- Pre-polish and main polish in one – save on additional operations

### BRIGHTEX® Sun:

- A mirror shine that's almost as if chrome-plated – the perfect finish
- For a final high gloss shine on polished metals
- For removing any leftover clouding and smears on all metals

## Technical Data:

Paste	Contents (g)	Application	Pkg. unit	Article number
BRIGHTEX® Berry pre-polishing paste	Approx. 1.100	Super polish	1	40025
BRIGHTEX® Sun final-polishing paste	Approx. 1.300	Top finish	1	40026

Suitable for

**ALL METALS**

# **BRIGHTEX<sup>®</sup> Softclean Powder**

A new and much improved cleaning powder removes all cream and paste residues after every polish and allows all metals to shine completely scratch-free in their best light. Replaces POLY Lime for a significantly better effect! Apply a little using the shaker and wipe off without applying any pressure using a clean microfibre cloth. Powder consists of ultra-fine micro-particles with a large surface area for the best possible absorbency.



**Technical Data:**

Packaging	Contents (g)	Pkg. unit	Article number
Resealable bag	Approx. 1,000	1	40028
Aluminium shaker	Approx. 200	1	40029

Suitable for

**ALL MATERIALS**

# **BRIGHTEX<sup>®</sup> Non-Scratch Cloth**



Much improved, ultra-soft microfibre cloth, free of seams for scratch-free cleaning of stainless steel surfaces and other decorative metals. Particularly soft and absorbent. Can be washed many times.

**Technical Data:**

Dimensions (mm)	Quality	Pkg. unit	Article number
400 x 400	360 g/m <sup>2</sup>	5	40031

Suitable for

**ALL METALS**

## Polishing Paste

Mirror finish polish for all metals (including aluminium).  
White for the pre polish and blue for the final polish.



### Technical Data:

Paste	Packaging	Contents (g)	Pkg. unit	Article number
White pre-polishing paste	Cardboard sleeve	Approx. 650	1	40013
Blue final-polishing paste	Cardboard sleeve	Approx. 650	1	40014
Mini pastes – white and blue	ZIP-LOCK bags	Approx. 120 (60 each)	1	40009

Suitable for

**ALL METALS**

## Pink Polishing Cream

For the final polish. Produces a flawless mirror finish on all metals when applied to SuperPolish, felt and polishing rings. Brings a quick shine – also suitable for manual application using polishing cloths, which is perfect for unusual shaped objects.

### Technical Data:

Packaging	Contents	Pkg. unit	Article number
Can	Approx. 1000 g	1	40015
Mini-tube	Approx. 60 ml	1	40015f



Suitable for

**ALL METALS**

## Microfibre Cloth

These microfibre cloths have a lightning-fast pore-deep cleaning effect and evenly distributes cleaning products onto the surface. It can also remove paste and cream residues.

### Technical Data:

Dimensions (mm)	Quality	Pkg. unit	Article number
400 x 400	290 g/m <sup>2</sup>	25	40030





Suitable for

**PIPE GRINDING · POLISHING**

# PIPE MAX

Multipurpose pipe grinding tool with gas pressure damping for perfect grinding and polishing on closed and open pipe constructions. Small to large pipe diameters.

### FEATURES

- Homogeneous, uniform grinding and polishing results for all pipe diameters big and small
- Patented gas pressure damping allows the grinding and polishing belts to be "enclosed around" the pipes to maximum effect with no great force
- New drive roller with replaceable rubber O rings guarantees the belts will run without slipping
- Contact wheel made from soft polyurethane ensures particularly soft contact and permanent elasticity
- The soft contact wheel also allows flat surfaces to be ground longitudinally, for example to remove spot welds and eliminate deep scratches, etc.
- Fast and easy belt change
- Ideal belt guide with stainless steel flanges  
No more adjustments required
- Balanced, multi-adjustable handle can be put into the optimum setting for the job in hand
- Can be set up for right and left-handed use or for side and overhead working
- The belt unit is made of gravity die-cast aluminium and is particularly strong and resistant
- Ideal for pipe diameters of 10 – 130 mm



## Technical Data: PIPE MAX Machine

Plug type	Cable type	Mains connection (V ~ Hz)	Power (W)	Belt dimensions (W x L mm)	Speed (rpm)	Weight (g)	Pkg. unit	Article number
EU (C+F)	QUICK-LOCK	220 – 240 ~ 50-60	1,750	40 x 780	1,000 – 3,800	4,800	1	38501
CH (J)	QUICK-LOCK	220 – 240 ~ 50-60	1,750	40 x 780	1,000 – 3,800	4,800	1	38501s
UK (G)	Permanent connection	110 ~ 50-60	1,600	40 x 780	1,000 – 3,800	4,800	1	38501a
US (B)	QUICK-LOCK	120 ~ 50-60	1,600	40 x 780	1,000 – 3,800	4,800	1	38501u

Accessories included in package: 1 PIPE MAX machine, 1 x 4 m cable, 1 grinding belt 60 grit

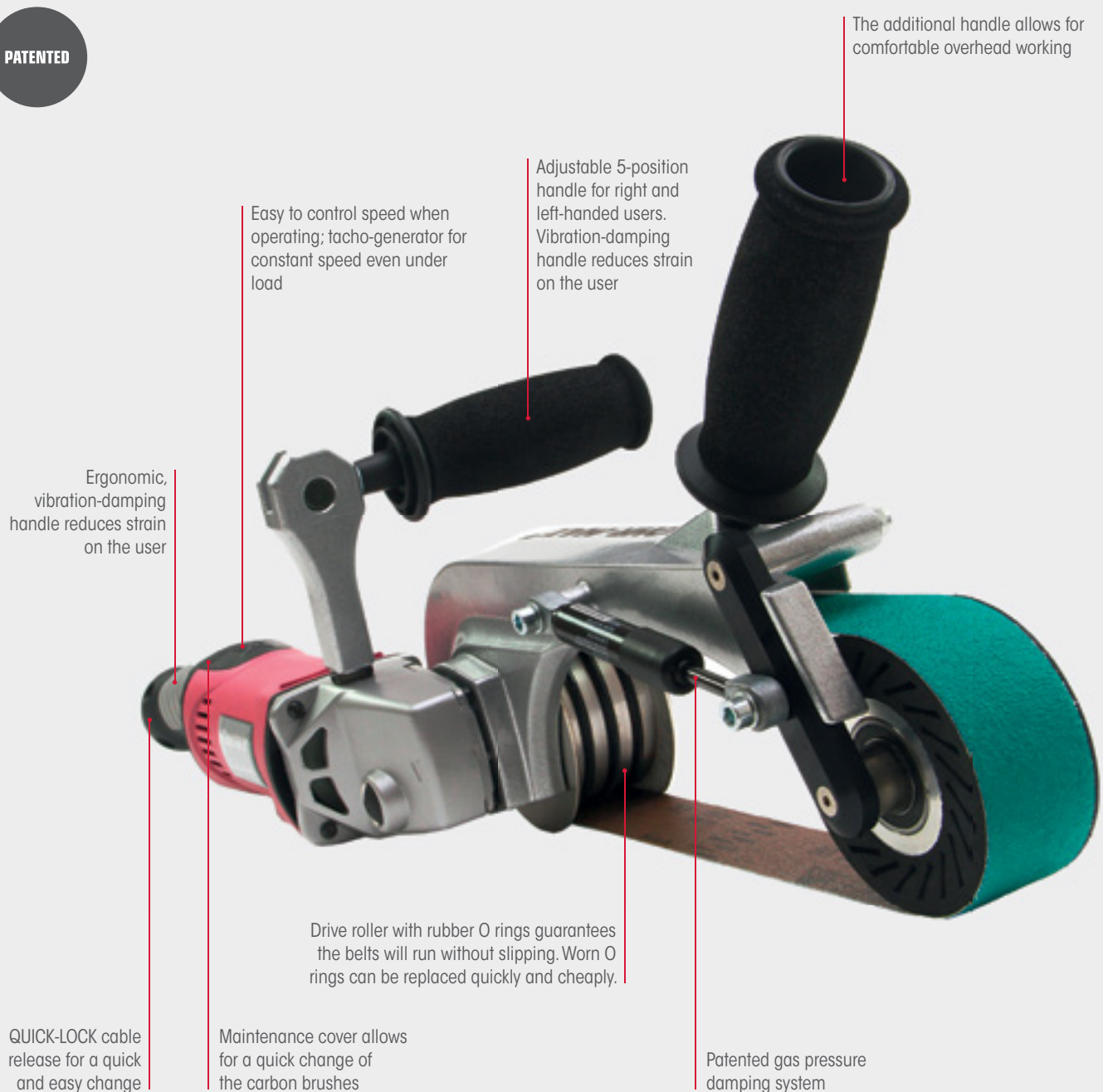

The additional handle allows for comfortable overhead working

Adjustable 5-position handle for right and left-handed users. Vibration-damping handle reduces strain on the user

Easy to control speed when operating; tacho-generator for constant speed even under load

Ergonomic, vibration-damping handle reduces strain on the user

Drive roller with rubber O rings guarantees the belts will run without slipping. Worn O rings can be replaced quickly and cheaply.

QUICK-LOCK cable release for a quick and easy change

Maintenance cover allows for a quick change of the carbon brushes

Patented gas pressure damping system

# PIPE MAX Metal Set

Pipe belt grinder



With the PIPE MAX metal set you'll always have the right tools on hand. The perfect pipe machining kit for a range of applications from coarse through to fine grinding (industrial grinding) in a sturdy carry case with handle.

**Technical Data:**

Plug type	Cable type	Mains connection (V ~ Hz)	Power (W)	Belt dimensions (W x L mm)	Speed (rpm)	Pkg. unit	Article number
EU (C+F)	QUICK-LOCK	220 – 240 ~ 50-60	1,750	40 x 780	1,000 – 3,800	1	38502
CH (J)	QUICK-LOCK	220 – 240 ~ 50-60	1,750	40 x 780	1,000 – 3,800	1	38502s
UK (G)	Permanent connection	110 – 50-60	1,600	40 x 780	1,000 – 3,800	1	38502a
US (B)	QUICK-LOCK	120 – 50-60	1,600	40 x 780	1,000 – 3,800	1	38502u

**Contents of Set:**

- 1 PIPE MAX machine
- 1 x 4 m QUICK-LOCK cable
- 1 Additional handle
- 3 Replacement rubber O rings
- 2 Special zirconium belts 40 grit
- 2 Special zirconium belts 60 grit
- 2 Special zirconium belts 80 grit
- 2 Special zirconium belts 120 grit
- 2 Special SC fleece belts medium
- 2 Special SC fleece belts fine





## QUICK-LOCK Cable

Suitable for VARILEX® WSF 900, 1600 & 1800, POLY-PTX® 300, 500 & 800 PROFESSIONAL, ROLEI EF 115, PIPE MAX, PIPE SNIPER® and GLADIUS® 1800.

### Technical Data:

Version	Cable length (m)	Voltage (V)	Pkg. unit	Article number
EU (C+F)	4	220 – 240	1	52004-3
EU (C+F)	10	220 – 240	1	52005-3
CH (J)	4	220 – 240	1	52004-3s
AU	4	220 – 240	1	52004-3a
UK (G)	4	110	1	52004-3e
US (B)	4	120	1	52004-3u
Plug adapter – EU to UK	4		1	52004d



### Changing the belt with the PIPE MAX

Changing belts with the PIPE MAX is very easy with the new damping system with gas pressure: simply push back the contact wheel and insert the grinding belt ... and you're ready to go!





# PIPE FIX DUO

## Belt grinding system

Compact machine for small pipes, handrails, etc., and for fitting and repair work. For machining pipes with interchangeable belt filing attachment and flat filing attachment. For grinding in hard to reach places.



### FEATURES

- Compact machine for small pipes, handrails, etc., and for fitting and repair work
- For perfect grinding and polishing on closed and open pipe constructions
- Easy to handle and powerful
- From coarse grinding to a mirror finish for all generally available handrail diameters
- Homogeneous, streak-free finish, even on long railings
- Optional flat filing attachment with flat metal guide slides allows grinding of surfaces with many small, complex components
- Can be quickly converted from a pipe grinder to an optional belt filer without tools
- Grind, file, polish and apply a satin finish to areas that are difficult to access using the optional belt filing attachment
- Infinitely adjustable speed
- Ideal for pipe diameters of 4 – 75 mm

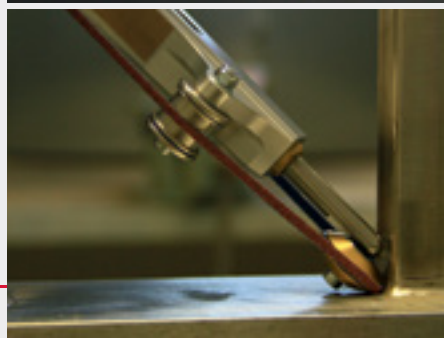

## Technical Data: PIPE FIX DUO Machine

Plug type	Cable type	Mains connection (V - Hz)	Power (W)	Belt dimensions – pipe belt grinder (W x L mm)	Belt dimensions – file attachments (W x L mm)	Speed (rpm)	Weight (g)	Pkg. unit	Article number
EU (C+F)	Permanent connection	220 – 240 ~ 50-60	850	60 x 260	3/5/9 x 533	900 – 5,400	3,000	1	38002

Accessories included in package: 1 PIPE FIX DUO machine, 1 x 4 m cable, 1 SC fleece sleeve

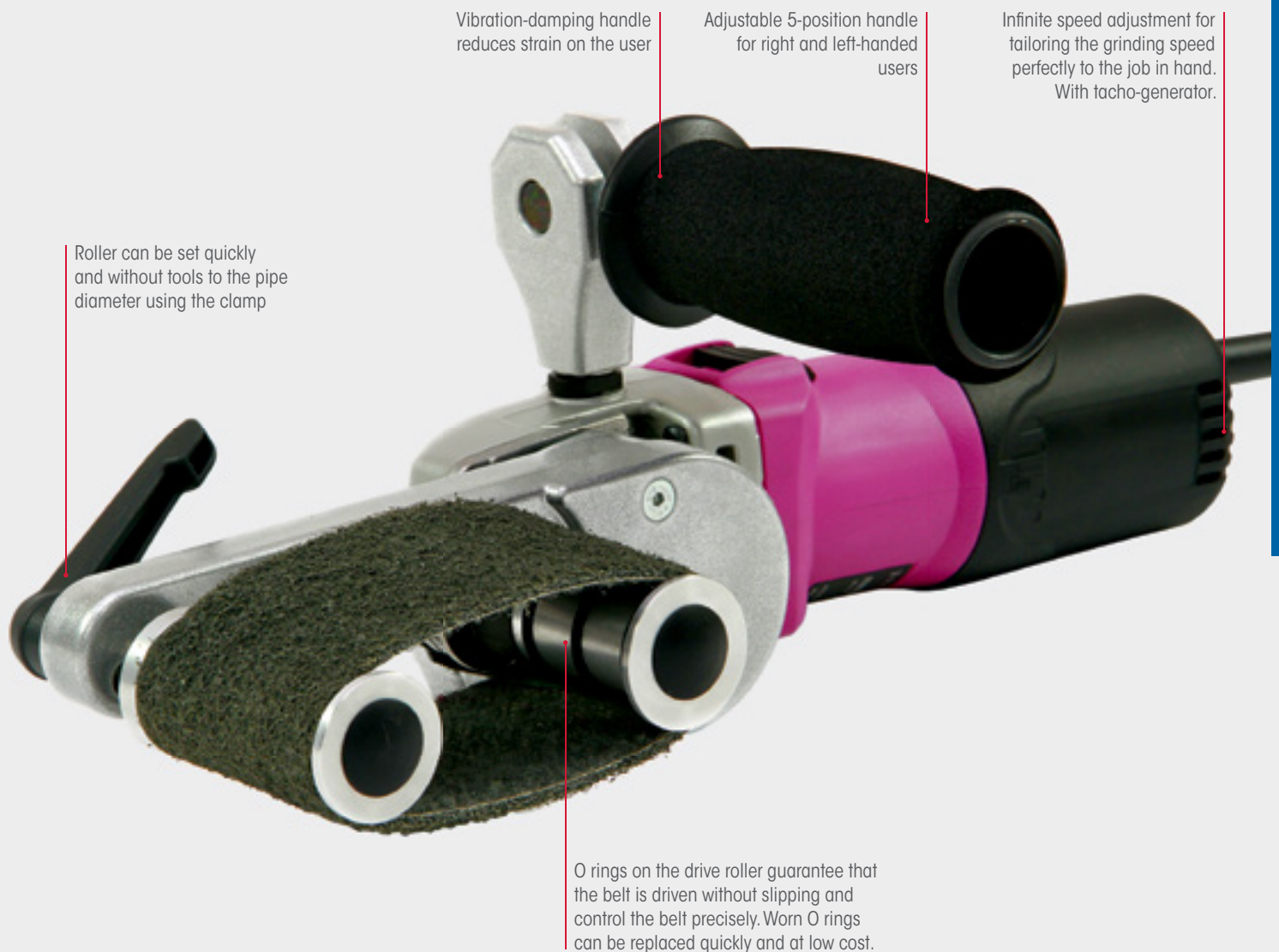

Vibration-damping handle reduces strain on the user

Adjustable 5-position handle for right and left-handed users

Infinite speed adjustment for tailoring the grinding speed perfectly to the job in hand. With tachogenerator.

Roller can be set quickly and without tools to the pipe diameter using the clamp

O rings on the drive roller guarantee that the belt is driven without slipping and control the belt precisely. Worn O rings can be replaced quickly and at low cost.

### Optional accessories:

PIPE FIX DUO has an interchangeable belt filing attachment and flat filing attachment

Belt filing attachment

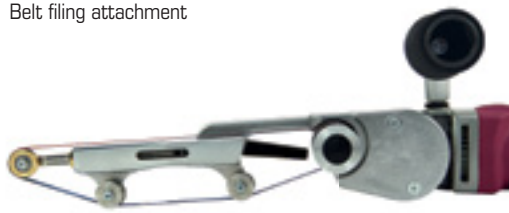

Flat filing attachment



# PIPE FIX DUO Metal Set

Belt grinding system



Practical set for round pipe machining from coarse grinding to a mirror finish supplied in a case. Can be retooled as a belt filer **(SEE ACCESSORY PACKAGE OR FLAT FILER ON PAGE 177)**.

**Technical Data:**

Plug type	Cable type	Mains connection (V ~ Hz)	Power (W)	Belt dimensions – pipe belt grinder (W x L mm)	Belt dimensions – file attachments (W x L mm)	Speed (rpm)	Pkg. unit	Article number
EU (C+F)	Permanent connection	220 – 240 ~ 50-60	850	60 x 260	3/5/9 x 533	900 – 5,400	1	38004

**Contents of Set:**

- 1 PIPE FIX DUO machine 850 watts
- 1 Carry case
- 2 Mini polishing pastes (white and blue)

- Round pipe machining:**
- 4 High quality corundum sleeves
  - 2 SC fleece sleeves
  - 2 SuperPolish sleeves
  - 2 Trizact™ sleeves

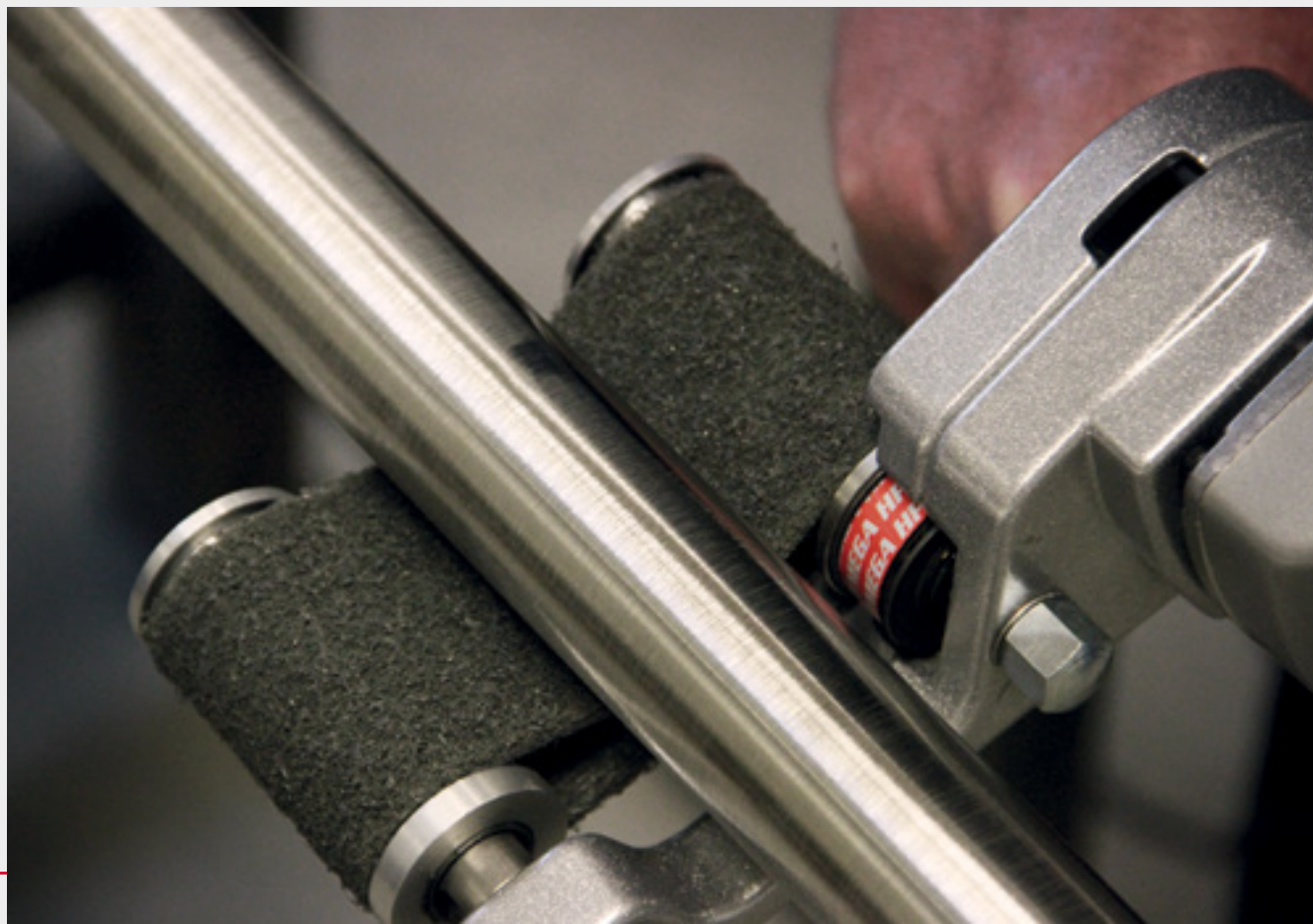



# PIPE FIX DUO Belt Filing Accessory Pack



Sturdy belt filing attachment with a comprehensive range of accessories for the professional application of the PIPE FIX DUO for grinding in "tight" places, pipe circumferences, pipe bending, etc.

### Technical Data:

Article	Belt filing attachment (for belts in mm)	Pkg. unit	Article number
Accessory package – belt filing attachment	3 / 5 / 9 x 533	1	38005

### Contents of Set:

- 1 Belt filing attachment for Ø 9 x 533 mm
- 1 SC fleece belt Ø 9 x 533 mm medium
- 2 Narrow felt belts 9 x 533 mm
- 2 High quality corundum belts 5 x 533 mm
- 2 High quality corundum belts 3 x 533 mm
- 4 High quality belts 9 x 533 mm 40, 60, 80, 120 grit
- 1 SC fleece belt 9 x 533 mm fine
- 1 Inter-changeable roller for 5 mm wide belts
- 1 Inter-changeable roller for 3 mm wide belts



3 mm



5 mm



9 mm

# PIPE FIX DUO Flat Filing Attachment



Perfect flat filing on small workpieces or for use as a stationary belt file in combination with the clamp. For use with 9 mm narrow belts.

### Technical Data:

Article	Flat filing attachment (for belts in mm)	Pkg. unit	Article number
Flat filing attachment	9 x 533	1	38010
Replacement plate		1	38011





# PIPE FIX SMART

## Mini pipe grinding system

Powerful grinding tool that saves time, space, is easy to operate and is ideal for machining thin round pipes, for example in the production of rails. Complete grinding of thin pipes possible from one working position. Even ideal for use on closed pipe constructions.



### FEATURES

- 2/3 enclosure allows for complete grinding of the pipe from one working position
- Machines small pipes and round bars of 9 to 30 mm diameter
- New guide handle for controlling the enclosure of the pipe
- Easy grinding of internal and the circumferences of bent pipes
- Powerful drive motor
- Ideal for pipe diameters of 9 – 30 mm
- Infinitely adjustable speed by means of a knurled setting wheel
- Clever automatic shut-down: Prevents overloads and returns back to power
- Small, practical pipe grinding and polishing tool
- Infinite setting of belt length without tools using adjustable clamp
- Balanced grinding to reduce strain on the user
- Ergonomic, vibration-damping handle with 5 settings (design copyright)
- Very sturdy design for professional use



## Technical Data: PIPE FIX SMART Machine

Plug type	Cable type	Mains connection (V ~ Hz)	Power (W)	Belt dimensions (W x L mm)	Speed (rpm)	Weight (g)	Pkg. unit	Article number
EU (C+F)	Permanent connection	220 – 240 ~ 50-60	850	9 x 533	900 – 5,400	3,600	1	38052

Accessories included in package: 1 PIPE FIX SMART machine, 1 x 4 m cable, 1 grinding belt grit 60

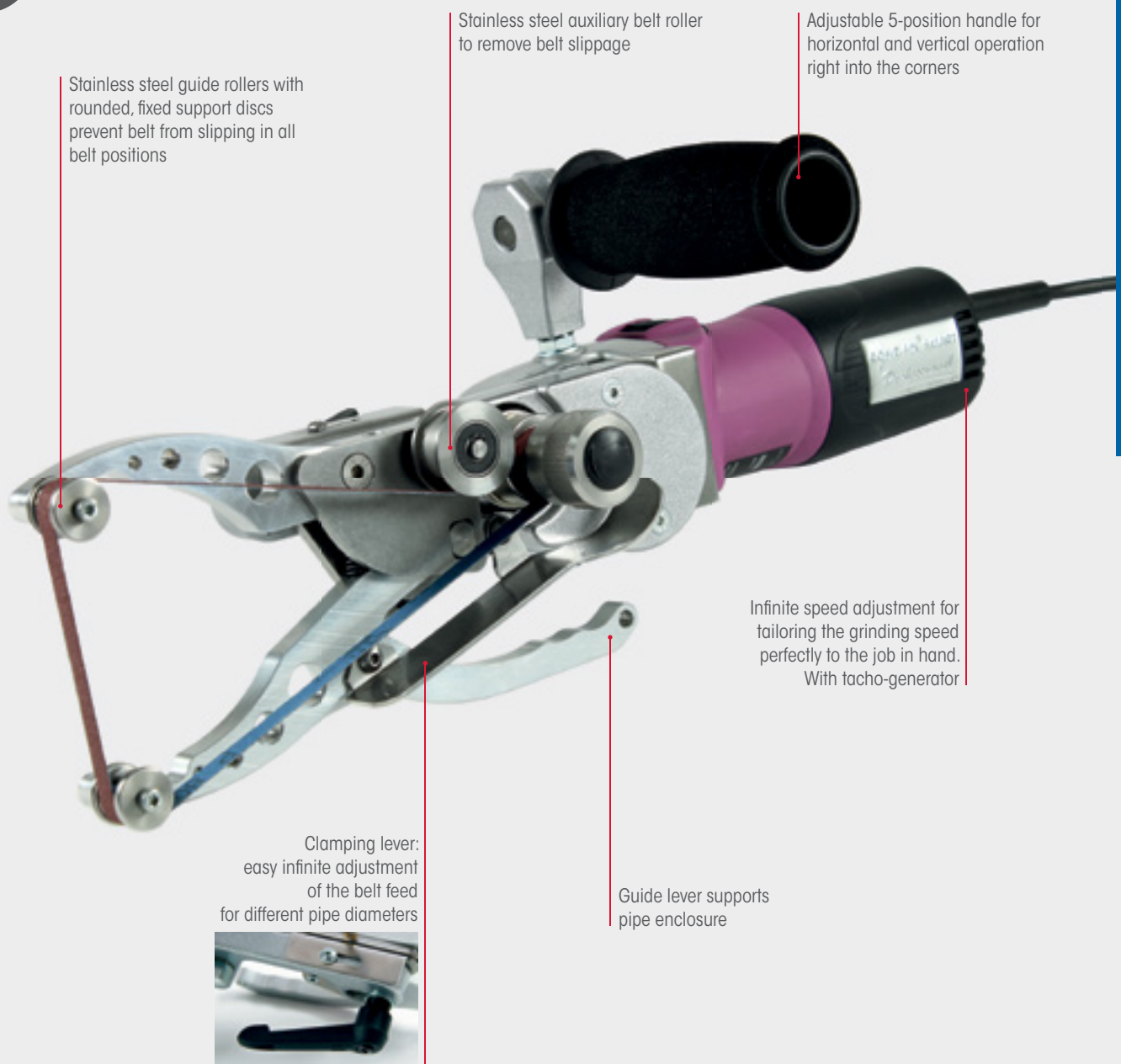

Stainless steel guide rollers with rounded, fixed support discs prevent belt from slipping in all belt positions

Stainless steel auxiliary belt roller to remove belt slippage

Adjustable 5-position handle for horizontal and vertical operation right into the corners

Infinite speed adjustment for tailoring the grinding speed perfectly to the job in hand. With tachogenerator

Clamping lever: easy infinite adjustment of the belt feed for different pipe diameters



Guide lever supports pipe enclosure

# PIPE FIX SMART Metal Set



Practical set for machining from coarse to fine on thin round pipes. Revolutionary new machine system for machining thinner round pipes of 10 – 40 mm diameter (for bent pipes as well). 2/3 enclosure allows for complete grinding of the pipe from one working position.

### Technical Data:

Plug type	Cable type	Mains connection (V - Hz)	Power (W)	Belt dimensions (W x L mm)	Speed (rpm)	Pkg. unit	Article number
EU (C+F)	Permanent connection	220 – 240 ~ 50-60	850	9 x 533	900 – 5,400	1	38053

### Contents of Set:

1 PIPE FIX machine 850 watts

- 10 High quality corundum belts 9 x 533 mm 60 grit
- 10 High quality corundum belts 9 x 533 mm 80 grit
- 10 High quality corundum belts 9 x 533 mm 120 grit
- 3 SC fleece belts 9 x 533 mm medium
- 3 SC fleece belts 9 x 533 mm fine

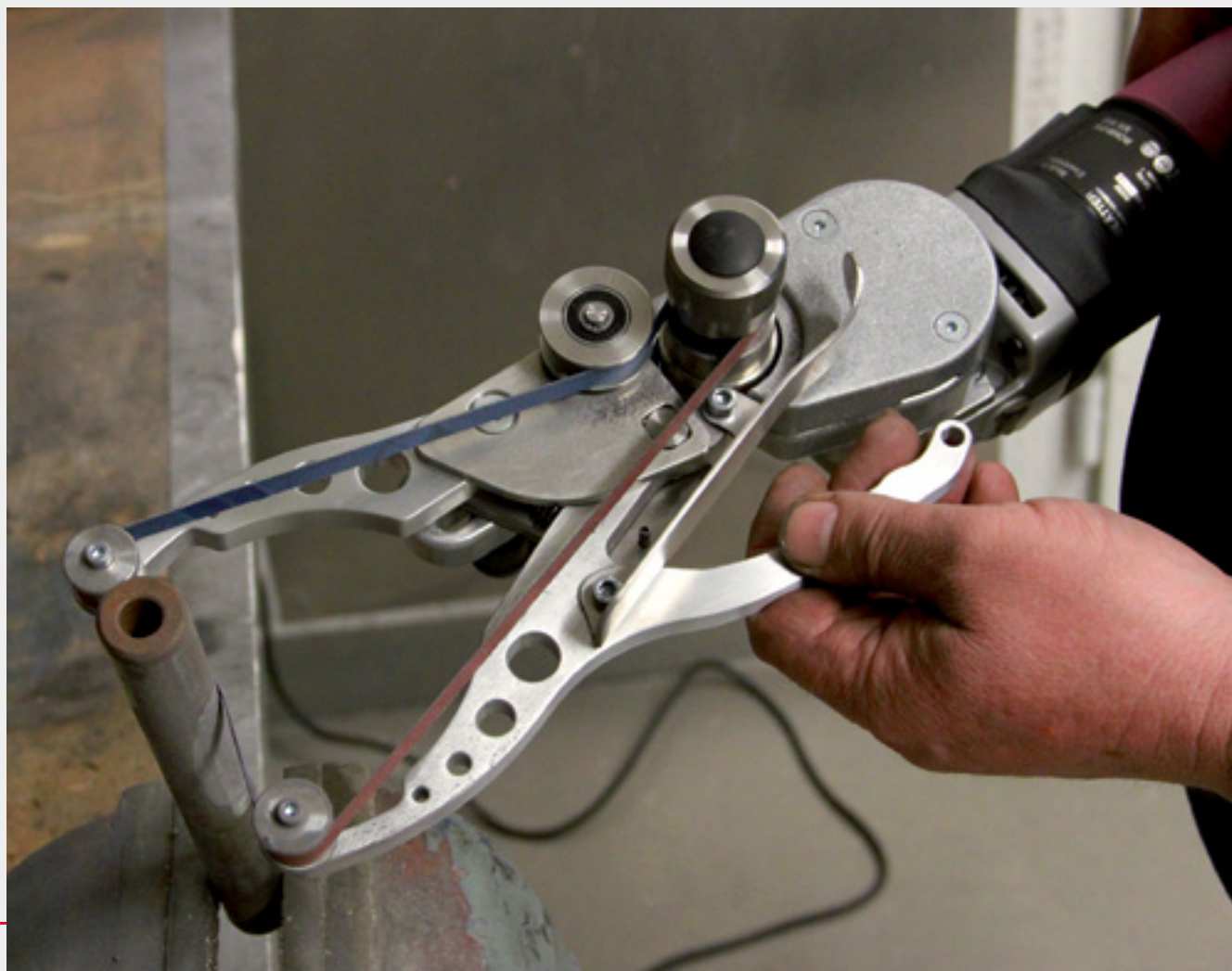



**360 degree  
pipe grinding  
from one  
working  
position!**



Suitable for

**PIPE GRINDING · POLISHING**

# PIPE SNIPER®

Pipe belt grinder

360° grinding from one working position. Revolution in pipe grinding with new lever enclosure system. With genuine 2/3 enclosure (for diameters of 30 to 42 mm). Very compact design with unique gas pressure damping system.

### FEATURES

- Minimal force is required due to the revolutionary, sophisticated enclosure system
- A world first: for the first time, the arms are closed by pressing a lever
- With a genuine 2/3 enclosure, it is possible to machine pipes completely through 360 degrees from one position
- Ideal for pipe diameters of 25 – 70 mm
- Innovative technology: new gas pressure damping system reduces force and allows pipe to be “gently” enclosed
- Newly developed drive motor with 1750-watt rating for continuous use in a professional application
- The balanced bar handle allows the tool to be operated easily in any conceivable position

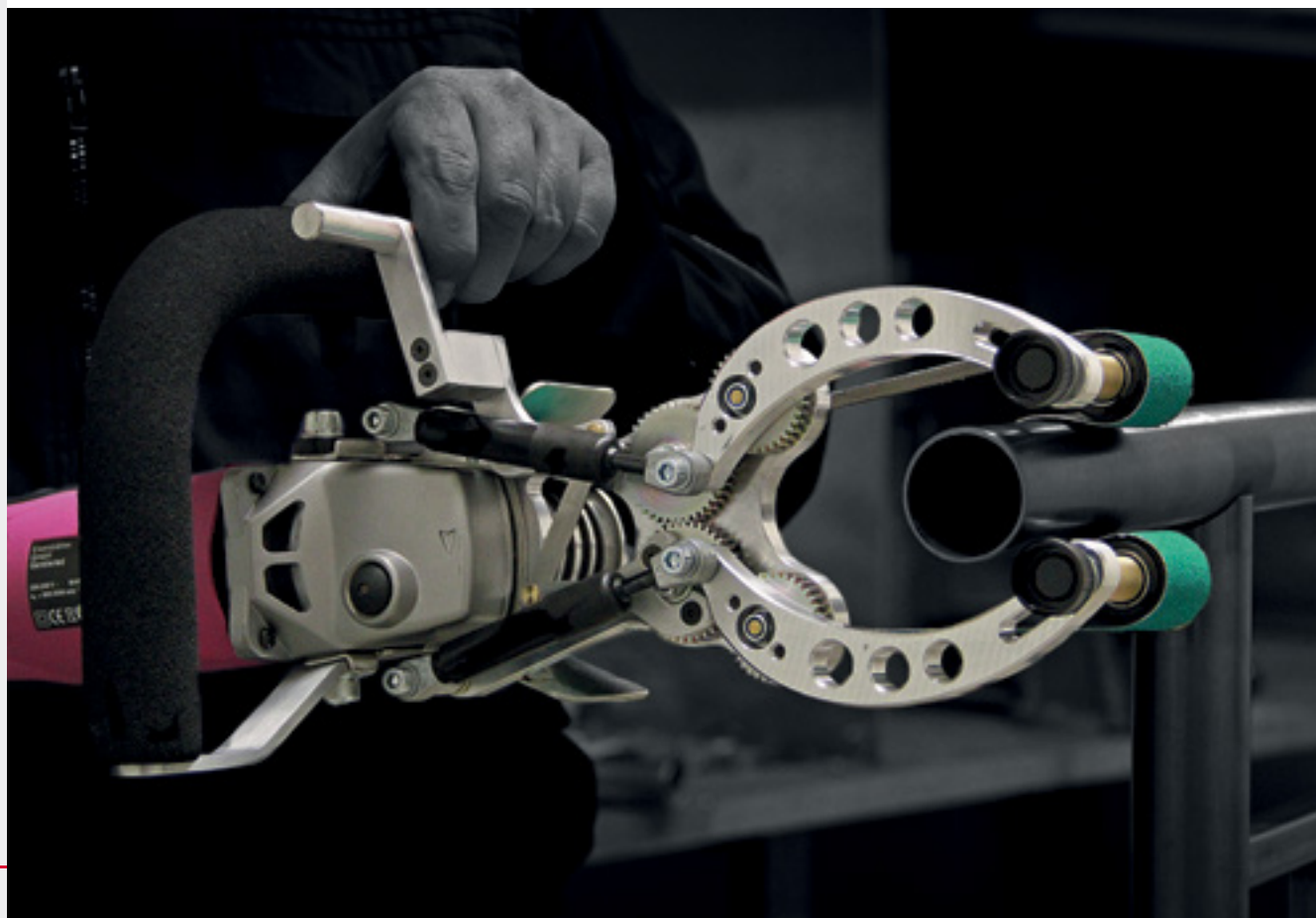
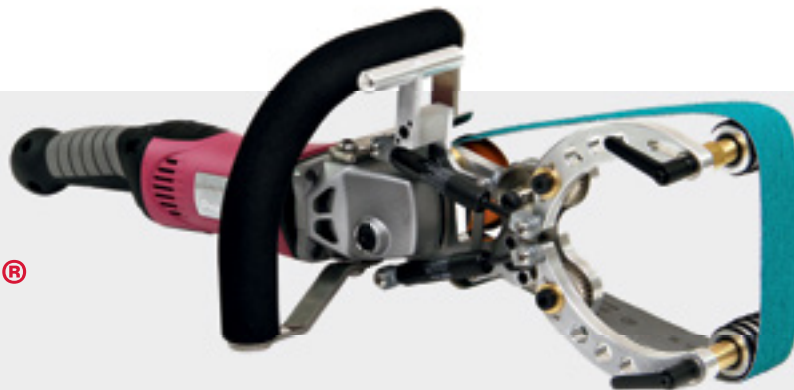

## Technical Data: PIPE SNIPER® Machine

Plug type	Cable type	Mains connection (V ~ Hz)	Power (W)	Belt dimensions (W x L mm)	Speed (rpm)	Weight (g)	Pkg. unit	Article number
EU (C+F)	QUICK-LOCK	220 – 240 ~ 50-60	1,750	40 x 780	1,000 – 3,800	4,800	1	38601
CH (J)	QUICK-LOCK	220 – 240 ~ 50-60	1,750	40 x 780	1,000 – 3,800	4,800	1	38601s
UK (G)	Permanent connection	110 ~ 50-60	1,600	40 x 780	1,000 – 3,800	4,800	1	38601a
US (B)	QUICK-LOCK	120 ~ 50-60	1,600	40 x 780	1,000 – 3,800	4,800	1	38601u

Accessories included in package: 1 PIPE SNIPER® machine, 1 x 4 m cable, 1 grinding belt 60 grit

PATENTED

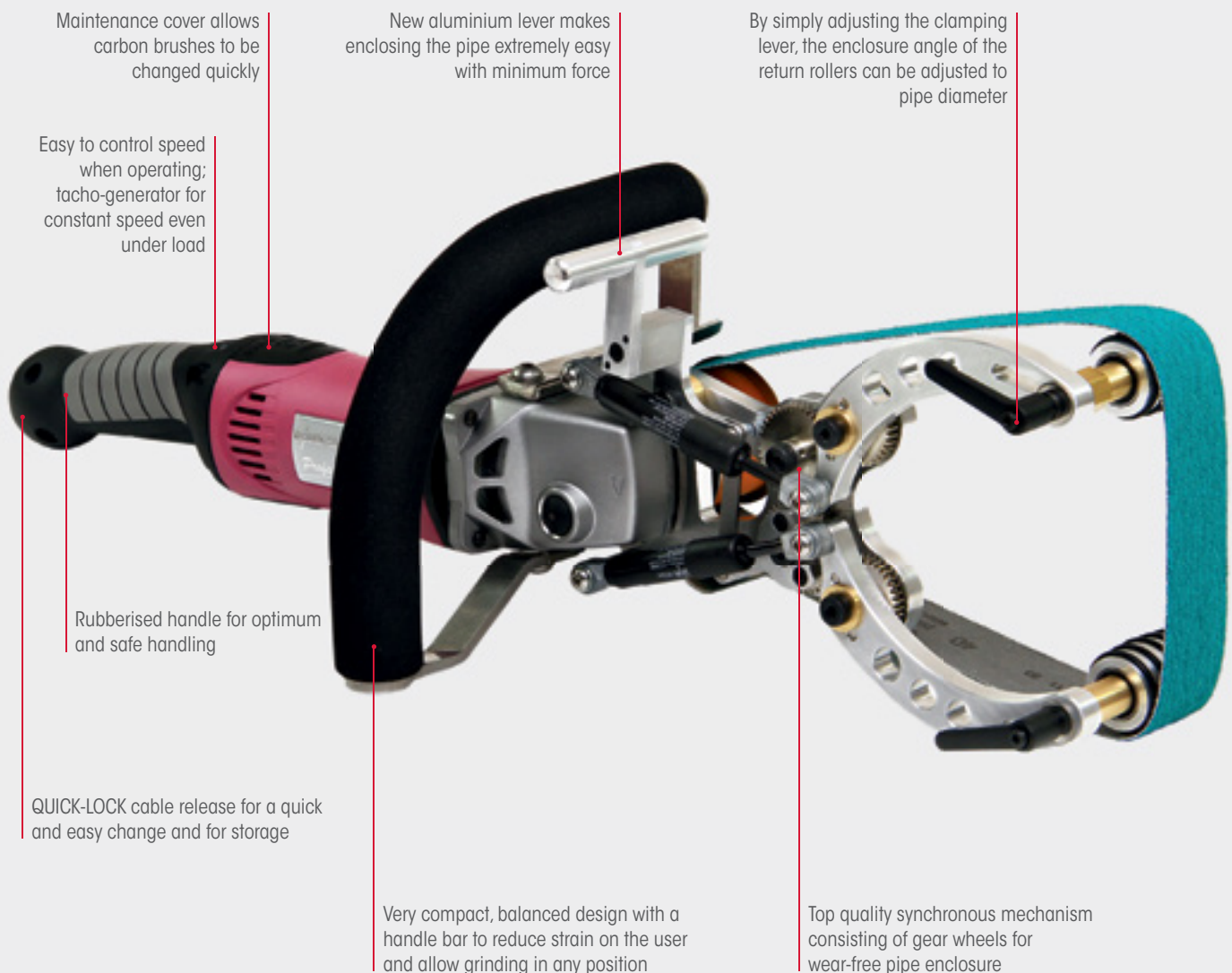

Suitable for

**COARSE TO FINE GRINDING**

# PIPE SNIPER® Metal Set



## Pipe belt grinder

Ideal metalworking set with PIPE SNIPER® machine and various grinding and fleece belts for perfect industrial grinding on pipes and flat surfaces (coarse to fine grinding).

### Technical Data:

Plug type	Cable type	Mains connection (V - Hz)	Power (W)	Belt dimensions (W x L mm)	Speed (rpm)	Pkg. unit	Article number
EU (C+F)	QUICK-LOCK	220 - 240 ~ 50-60	1,750	40 x 780	1,000 - 3,800	1	38602
CH (J)	QUICK-LOCK	220 - 240 ~ 50-60	1,750	40 x 780	1,000 - 3,800	1	38602s
UK (G)	Permanent connection	110 - 50-60	1,600	40 x 780	1,000 - 3,800	1	38602a
US (B)	QUICK-LOCK	120 - 50-60	1,750	40 x 780	1,000 - 3,800	1	38602u

### Contents of Set:

- 1 PIPE SNIPER® machine
- 1 x 4 m cable

- 2 Special zirconium belts 40 grit
- 2 Special zirconium belts 60 grit
- 2 Special zirconium belts 80 grit
- 2 Special zirconium belts 120 grit
- 2 Special SC fleece belts medium
- 2 Special SC fleece belts fine







## The Eisenblätter Demo Bus comes to you!

Eisenblätter Demo Center: Tel. (+49) 2633 2000 982 · [demo@eisenblaetter.de](mailto:demo@eisenblaetter.de)  
Koblenzer Str. 29a · DE-56656 Brohl-Lützing



Limited to Germany and surrounding European countries. Get in touch with us to see possibilities.



# GLADIUS® 1800

The multipurpose grinding sword – belt grinder, surface grinder, belt polisher, deburring tool and wood processor in one!



De-rusting, removal of scale and cleaning of surfaces in the shortest possible time without rounding edges. Hollow constructions can be ground out due to the unique shape of the Gladius. Large contact surface produces perfect, uniform flat grinding and is perfect for high quality deburring at a wide variety of angles (bevel grinding). Even round rods can be given smooth surfaces in a short amount of time.

### FEATURES

- The design of the GLADIUS allows machining processes to be undertaken that were previously impossible
- Grinds smoothly and without jumping on both sides of the sword
- Long, sword-shaped, belt arm for processing previously inaccessible areas
- Allows sharp-edged grinding operations to be easily carried out in corners of metal constructions
- For mobile and stationary use: optional equipment stand turns the machine into a bench-mounted device for precision working (e.g. deburring, bevelling)
- Even round rods of widely differing diameters can be given smooth surfaces in the shortest possible time
- The world's most powerful drive motor in its class and size ensures top quality working results, even for continuous operation
- Ideal for all metals, wood and plastics

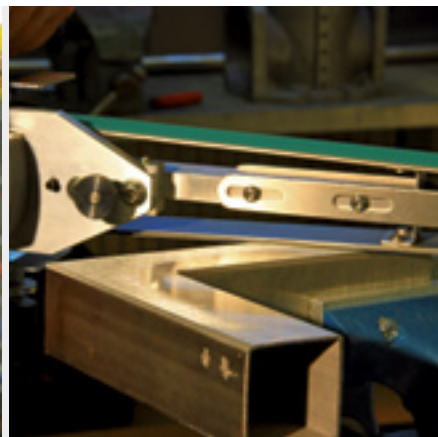

## Technical Data: GLADIUS® 1800 Machine

Plug type	Cable type	Mains connection (V ~ Hz)	Power (W)	Speed (rpm)	Belt dimensions (mm)	Weight (g)	Pkg. unit	Article number
EU (C+F)	QUICK-LOCK	220 – 240 ~ 50-60	1,750	1,000 – 3,800	40 x 780	5,400	1	38651
CH (J)	QUICK-LOCK	220 – 240 ~ 50-60	1,750	1,000 – 3,800	40 x 780	5,400	1	38651s
UK (G)	Permanent connection	110 ~ 50-60	1,600	1,000 – 3,800	40 x 780	5,400	1	38651a
US (B)	QUICK-LOCK	120 ~ 50-60	1,600	1,000 – 3,800	40 x 780	5,400	1	38651u

Accessories included in package: 1 GLADIUS® 1800 machine, 1 x 4 m cable, 1 grinding belt 60 grit

PATENTED

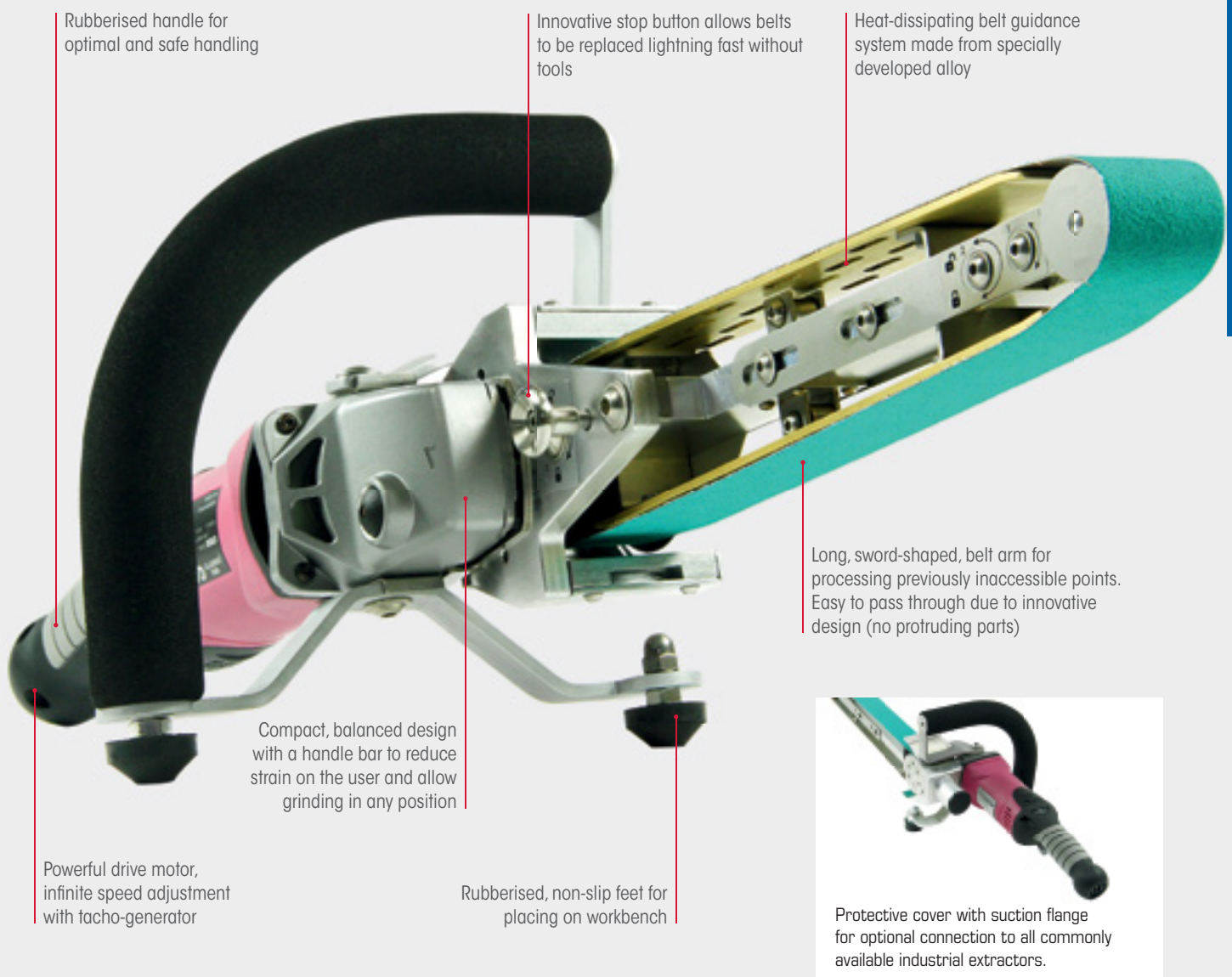

BELT GRINDING

# GLADIUS® 1800 Metal Set

In a sturdy aluminium case



Belt grinder, surface grinder, belt polisher, deburring tool and wood processor in one! The design of the GLADIUS® allows machining processes to be undertaken that were previously impossible, such as sharp-edged grinding in corners, perfect flat grinding with no chatter marks and so on. As well as the machine itself, the set also contains the top quality equipment stand for stationary working and belts for coarse to fine grinding.

## Technical Data:

Plug type	Cable type	Mains connection (V - Hz)	Power (W)	Speed (rpm)	Belt dimensions (mm)	Pkg. unit	Article number
EU (C+F)	QUICK-LOCK	220 - 240 ~ 50-60	1,750	1,000 - 3,800	40 x 780	1	38652
UK (G)	Permanent connection	110 ~ 50-60	1,600	1,000 - 3,800	40 x 780	1	38652a
CH (J)	QUICK-LOCK	220 - 240 ~ 50-60	1,750	1,000 - 3,800	40 x 780	1	38652s
US (B)	QUICK-LOCK	120 ~ 50-60	1,710	1,000 - 3,800	40 x 780	1	38652u

## Contents of Set:

1 GLADIUS® 1800 machine

1 Sturdy aluminium case  
1 x 4 m cable  
1 GLADIUS® 1800 equipment stand

2 Special zirconium belts 40 grit  
2 Special zirconium belts 60 grit  
2 Special zirconium belts 80 grit  
2 Special zirconium belts 120 grit  
2 Special SC fleece belts medium  
2 Special SC fleece belts fine

**QUICK-LOCK Cable**

Suitable for VARILEX® WSF 900, 1600 & 1800, POLY-PTX® 300, 500 & 800 PROFESSIONAL, ROLEI EF 115, PIPE MAX, PIPE SNIPER® and GLADIUS® 1800.



**Technical Data:**

Version	Cable length (m)	Voltage (V)	Pkg. unit	Article number
EU (C+F)	4	220 – 240	1	52004-3
EU (C+F)	10	220 – 240	1	52005-3
CH (J)	4	220 – 240	1	52004-3s
AU	4	220 – 240	1	52004-3a
UK (G)	4	110	1	52004-3e
US (B)	4	120	1	52004-3u
Plug adapter – EU to UK	4		1	52004d



**GLADIUS® 1800 Machine Stand**

**For stationary working**

Solid, powder-coated design with non-slip rubber surface and corrosion-free stainless steel fittings. Handmade in Germany. It can also be attached to the table with screw clamps on many sides due to the flat design. For mobile and stationary use: the equipment stand turns the machine into a workbench tool for precision working.



**Technical Data:**

Material	Pkg. unit	Article number
Steel, powder-coated	1	38660

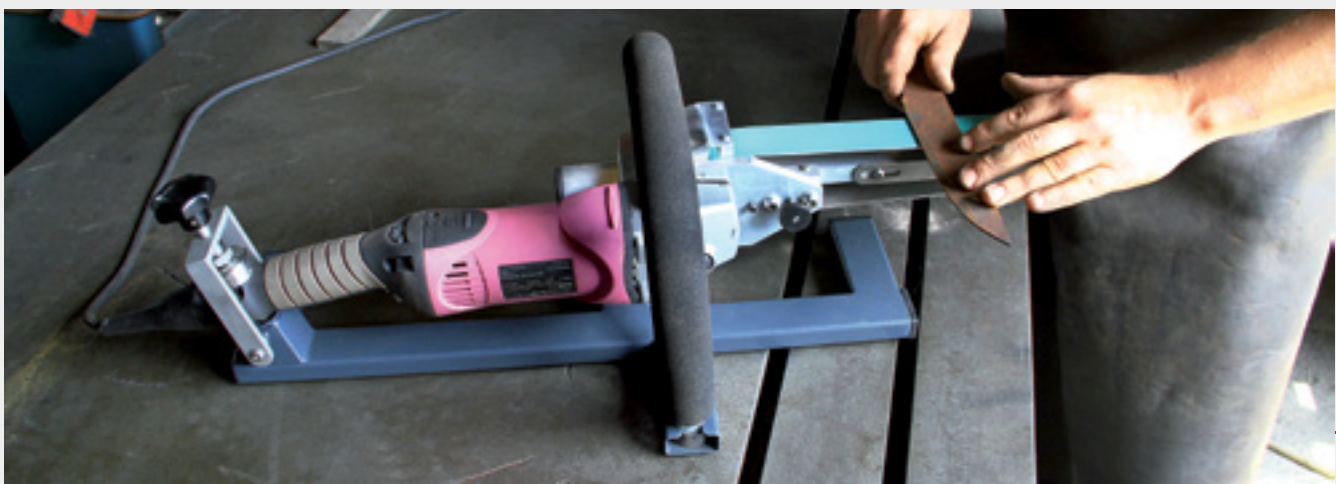



A man with a beard and safety glasses on his head, wearing a white tank top, is smiling while holding a rectangular metal block. He is standing in a factory or industrial setting, next to a metalworking machine with a red top. The background shows a staircase and industrial structures. The text "If you can't stand sharp burrs!" is overlaid on the right side of the image.

**If you can't  
stand sharp  
burrs!**

# DEBURRING AND BEVELLING

## POWER TOOLS ..... 192

ROLEI EF 115 .....	192
QUICK-LOCK Cable .....	194
Plastic Replacement Guide Rail .....	194
ZIRCOTEX® Nylon Flat .....	194

## ROLEI DEBURRING SYSTEM ..... 195

## STATIONARY MACHINES ..... 196

ROLEI EF 165 .....	196
ROLEI Special Flap Disc .....	198
ROLEI HellFire® Special Flap Disc .....	198
Extended Support Table .....	199
ROLEI EF 165 Machine Stand .....	199
ROLEI PEF 500 .....	200
ROLEI Special Flap Disc .....	202
ROLEI HellFire® Special Flap Disc .....	202
ROLEI PEF 500 Accessory Pack .....	203
ROLEI PEF 500 Machine Stand .....	203
ROLEI BE 5 Sheet Metal Deburring Machine .....	204
Teflon Strips (self-adhesive) .....	206
ROLEI BE 5 Flap Wheel .....	206
ROLEI BE 5 Machine Stand .....	207

# ROLEI EF 115

Manual deburring and bevelling tool



Practical deburring machine for cumbersome, heavy components such as large machine tables, frame constructions or large metal panels. Easy to handle and good edge control. The ROLEI EF 115 is also ideal for weld chamfering. Fixed bevel angle 45° and infinitely adjustable bevel width from 0 to 10 mm. Now with a rubberised handle for excellent handling.

The handy ROLEI EF 115 allows you to deburr and facet large heavy components easily. Precision edge guidance guarantees chamfers at 45° with no counter-burr.

### FEATURES

- Extremely powerful motor for continuous use
- Particularly sturdy, wear-resistant solid cast iron parts
- Lightning fast adjustment of bevel width
- Balanced handle reduces strain on the user
- Changing the disc is faster and more straightforward
- Various grades of grit for the tools can be supplied (coarse to fine)
- Ideal for chamfering welds. Also suitable for wider weld bevels





**Technical Data: ROLEI EF 115 Machine**

Plug type	Cable type	Mains connection (V - Hz)	Power (W)	Speed (rpm)	Bevel angle	Bevel width (mm)	Weight (g)	Pkg. unit	Article number
EU (C+F)	QUICK-LOCK	220 - 240 ~ 50-60	1,750	2,000 - 7,600	45°	0 - 10	4,100	1	30115
UK (G)	Permanent connection	110 ~ 50-60	1,600	2,000 - 7,600	45°	0 - 10	4,100	1	30116

Accessories included in package: 1 ROLEI EF 115 machine, 1 x 4 m cable, 1 flap disc 50 grit

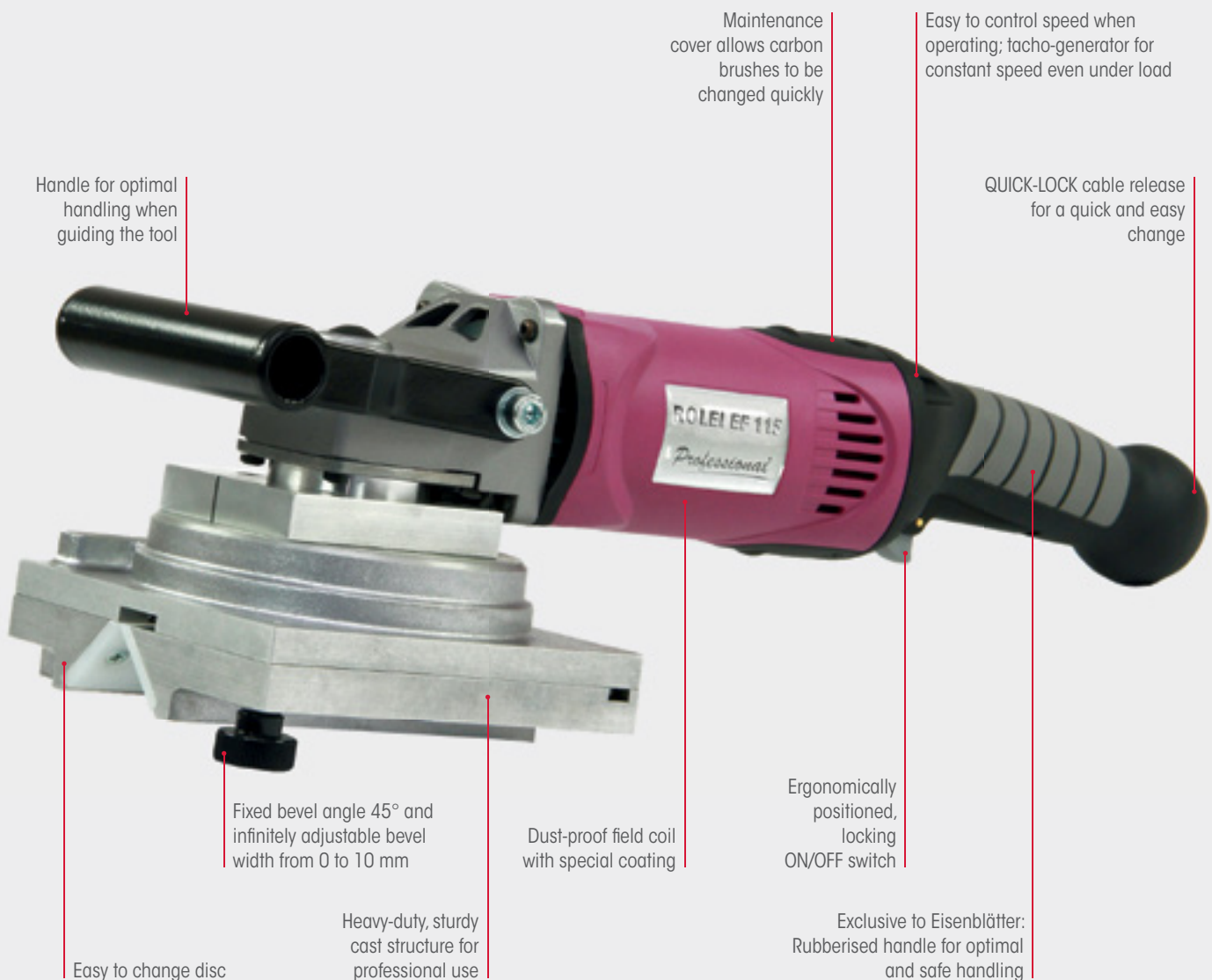

Handle for optimal handling when guiding the tool

Maintenance cover allows carbon brushes to be changed quickly

Easy to control speed when operating; tacho-generator for constant speed even under load

QUICK-LOCK cable release for a quick and easy change

Fixed bevel angle 45° and infinitely adjustable bevel width from 0 to 10 mm

Dust-proof field coil with special coating

Ergonomically positioned, locking ON/OFF switch

Easy to change disc

Heavy-duty, sturdy cast structure for professional use

Exclusive to Eisenblätter: Rubberised handle for optimal and safe handling



## QUICK-LOCK Cable

Suitable for VARILEX® WSF 900, 1600 & 1800, POLY-PTX® 300, 500 & 800 PROFESSIONAL, ROLEI EF 115, PIPE MAX, PIPE SNIPER® and GLADIUS® 1800.

### Technical Data:

Version	Cable length (m)	Voltage (V)	Pkg. unit	Article number
EU (C+F)	4	220 – 240	1	52004-3
EU (C+F)	10	220 – 240	1	52005-3
CH (J)	4	220 – 240	1	52004-3s
AU	4	220 – 240	1	52004-3a
UK (G)	4	110	1	52004-3e
US (B)	4	120	1	52004-3u
Plug adapter – EU to UK	4		1	52004d



Suitable for

**ROLEI EF 115**

## ROLLEI EF 115 Plastic Replacement Guide Rail

Replacement guide rails for fitting to the ROLEI EF 115 (1 pack = 2 pcs).

### Technical Data:

Pkg. unit	Article number
1	30117



Suitable for

**STEEL · STAINLESS STEEL · CAST IRON · NON-FERROUS METALS · ALUMINIUM**

## ZIRCOTEX® Nylon Flat

The legendary flat flap disc (hard compressed). Ideal for grinding welds for steel fabrication. Replacement disc for ROLEI EF 115.

**SEE PAGE 50 FOR MORE DETAILS.**

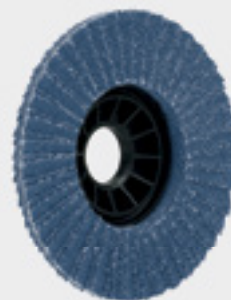

## Basic principle of ROLEI deburring system

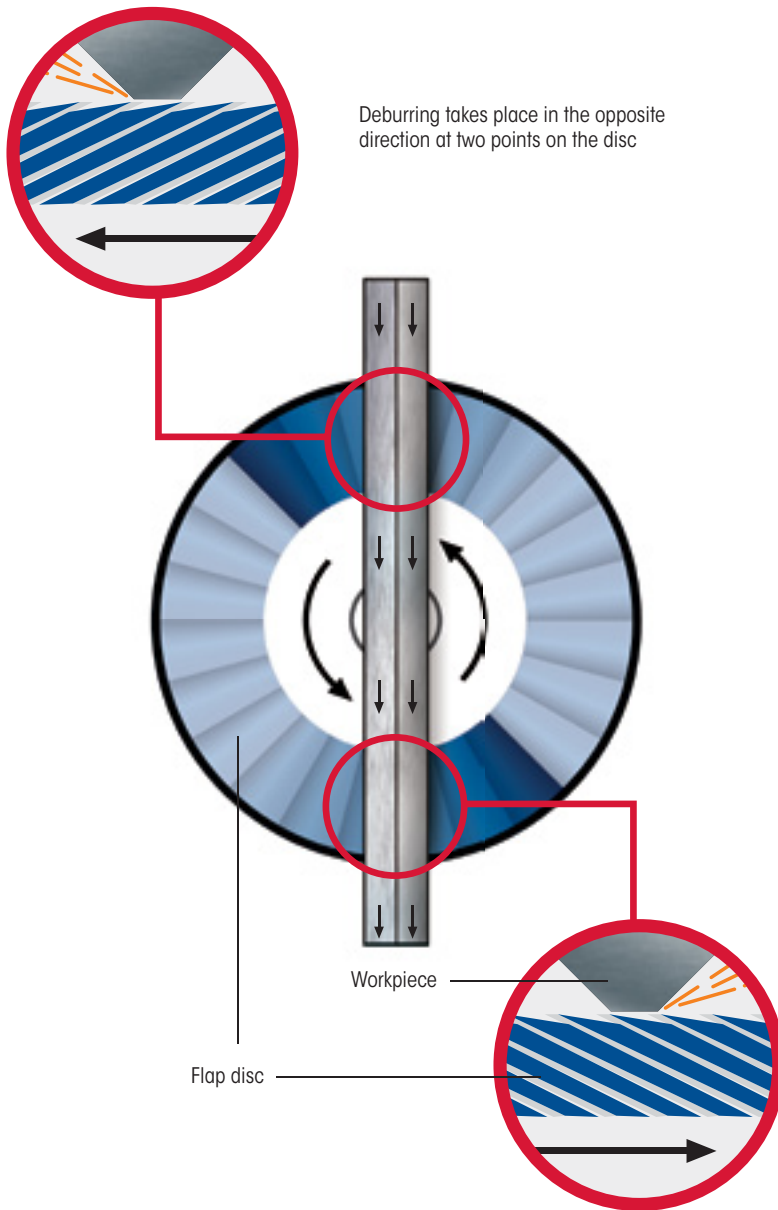

Grinding instead of milling saves a considerable amount of time and tool costs. Perfect cross-grinding in one operation guarantees edges with no counter-burr or chatter marks. All metals, including stainless steel, can be worked with this flexible deburring tool.

ROLEI deburring and bevelling machines work with flat flap discs (the BE 5 sheet metal deburring machine with flap wheels). The grinding tools are "self-sharpening" and have an extremely long service life.

The machines are easy and safe to operate and the grinding tools can be changed quickly and easily.

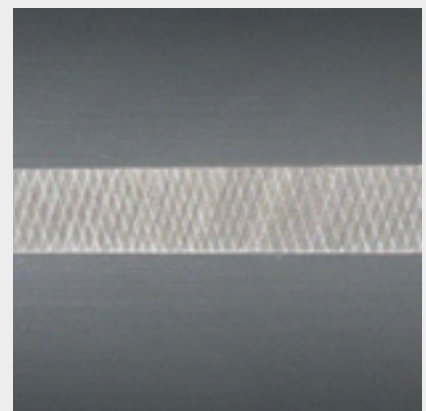
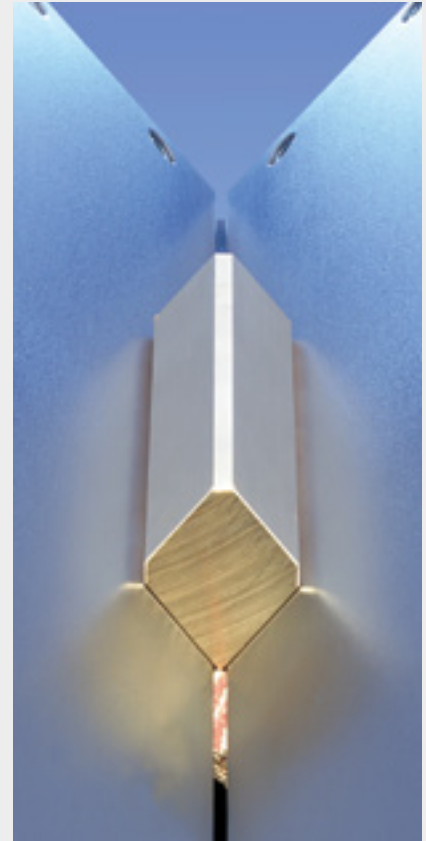

# ROLEI EF 165

for bevels of 45°

Bevelling and deburring machine with fixed bevel angle and infinitely adjustable bevel width for all metals from stainless steel to aluminium. A hand wheel provides for infinite and precision setting of the bevel width. Eisenblätter was awarded the Bavarian State Prize for its deburring machine at the Internationale Handwerksmesse show in Munich.

IMPROVED



### FEATURES

- Easy to operate without prior knowledge
- Value-for-money replacement tool with an extremely long service life (one disc can often be used for months)
- Bevelling can be undertaken with workpieces from 2.5 mm in thickness
- NEW: Suction flange for common industrial extractors supplied as standard (internal diameter 35 mm)
- Winner of the Bavarian State Prize

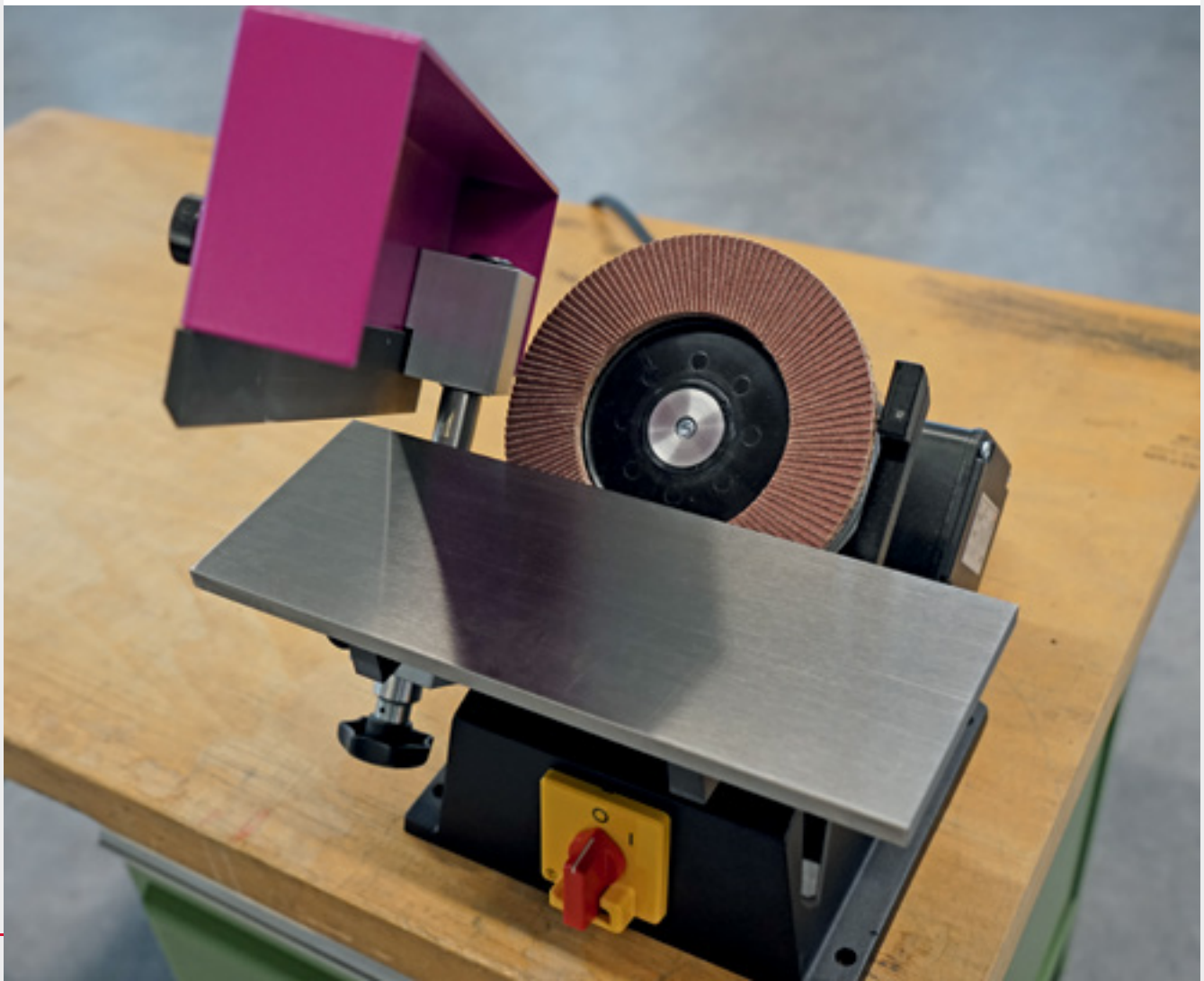

## Technical Data: ROLEI EF 165 Machine

Dimensions (mm)	Plug type	Mains connection (V ~ Hz)	Speed (rpm)	Bevel angle	Bevel width (mm)	Weight (kg)	Pkg. unit	Article number
360 x 320 x 300	3-phase	380 ~ 50	2,800	45°	0 – 10	Approx. 18	1	30100
360 x 320 x 300	EU (C+F)	220 – 240 ~ 50-60	2,800	45°	0 – 10	Approx. 18	1	30101

Accessories included in package: 1 ROLEI EF 165 machine, 1 flap disc 60 grit

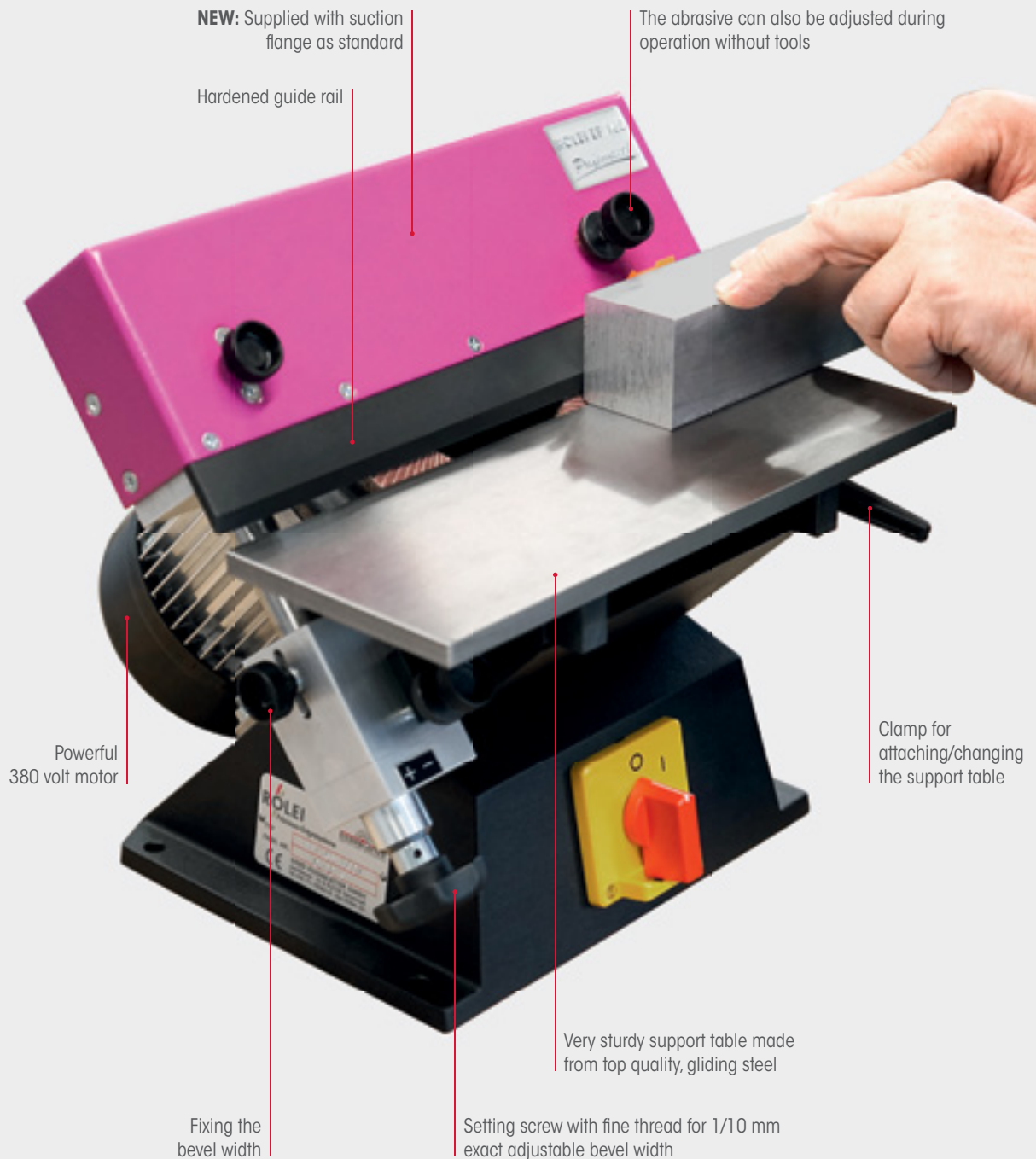



Suitable for

**STEEL · STAINLESS STEEL · NON-FERROUS METALS**

## ROLEI Special Flap Disc

The flap disc with especially hard compression for deburring machines. Self-sharpening and has an extremely long service life.



### Technical Data:

Dimensions (mm)	Suitable for	Pkg. unit	Grit (K)	Article number
170 x 22	ROLEI EF 165, ROLEI PEF 500	1	50	36050
			60	36060
			80	36080
			120	36120

### CHOOSE THE RIGHT GRIT/DISC:

Stainless steel, steel . . . .50 grit/60 grit  
Aluminium, copper, brass .80 grit/120 grit  
Hard plastic . . . . .120 grit



Suitable for

**ALL METALS**

## ROLEI HellFire® Special Flap Disc

Ceramic hybrid disc for particularly high rate of metal removal in one operation. Suitable for larger bevel widths due to its high aggressivity. Coarse to medium application; grinds all metals from steel, stainless steel and titanium through to non-ferrous metals.



### Technical Data:

Dimensions (mm)	Suitable for	Pkg. unit	Grit (K)	Article number
170 x 22	ROLEI EF 165, ROLEI PEF 500	1	Multigrain 40/60	36046

### CHOOSE THE RIGHT GRIT/DISC:

All metals. . . . . Multigrain 40/60



Suitable for

**ROLEI EF 165**

## ROLEI EF 165 Extended Support Table

Made from gliding steel (1.2842).

### Technical Data:

Dimensions (mm)	Pkg. unit	Article number
120 x 700	1	30110
Other dimensions available on request.		



Suitable for

**ROLEI EF 165**

## ROLEI EF 165 Machine Stand

Sturdy steel machine stand incl. fixing bolts with black powder coating for working comfortably in a standing position.

### Technical Data:

Dimensions (L x W x H) (mm)	Weight (kg)	Pkg. unit	Article number
245 x 215 x 660	Approx. 20	1	30120



# ROLEI PEF 500

for facets of 30° – 45° – 60°

Very sturdy precision deburring and bevelling tool for all materials from stainless steel to aluminium. Bevel angle can be set and bevel width is infinitely adjustable (precision setting by means of knurled division). The bevel width can be adjusted precisely using a hand wheel. Parts are bevelled by perfect cross-hatched grinding and with absolutely no counter-burr. The disc wear is adjusted using a hand wheel with a threaded spindle. The facet angle is adjusted using a motorised system. Suction flange is also available for common industrial extractors.



- Easy to operate without prior knowledge
- Value-for-money replacement tool with an extremely long service life (one disc can often be used for months)
- NEW: Suction flange for industrial extractors supplied as standard (internal diameter 35 mm)
- Bevelling can be undertaken with workpieces from 2.5 mm in thickness



## Technical Data: ROLEI PEF 500 Machine

Dimensions (mm)	Plug type	Mains connection (V ~ Hz)	Speed (rpm)	Bevel angle	Bevel width (mm)	Weight (kg)	Pkg. unit	Article number
500 x 350 x 350	3-phase	380 ~ 50	2,800	30° - 45° - 60°	0 - 10	45	1	30200
500 x 350 x 350	EU (C+F)	220 - 240 ~ 50-60	2,800	30° - 45° - 60°	0 - 10	45	1	30201

Accessories included in package: 1 ROLEI PEF 500 machine, 1 flap disc 60 grit

Very sturdy 700 mm guiding rail made from top quality, gliding steel

Hard compression special flap disc with an extremely long service life

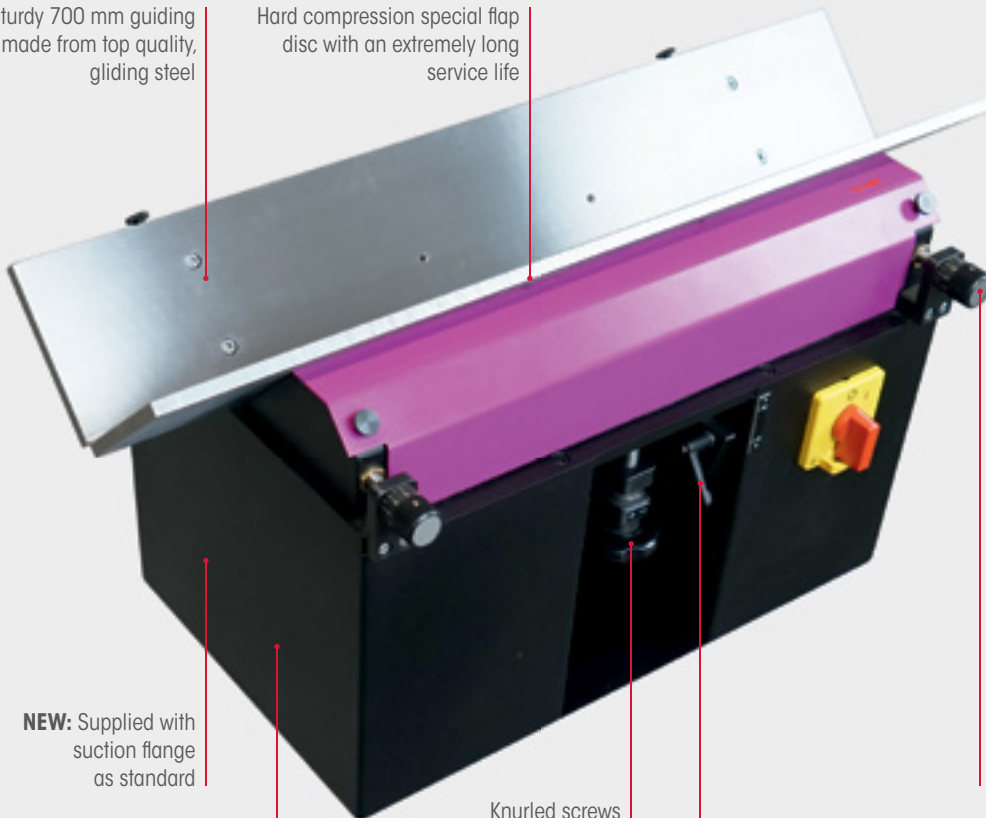

**NEW:** Supplied with suction flange as standard

Powerful 380 volt motor

Knurled screws for adjusting the abrasive during operation without tools

Infinitely adjustable bevel angle (30° - 45° - 60°)

Setting screw with fine thread for 1/10 mm exact adjustable bevel width

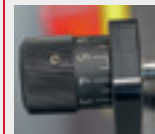

Now bevel and deburr thin sheet metals and long square bars with an optional thin sheet metal accessory package (see page 203).

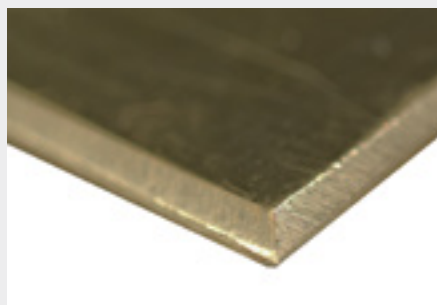



Suitable for

**STEEL · STAINLESS STEEL · NON-FERROUS METALS**

## ROLEI Special Flap Disc

The flap disc with especially hard compression for deburring machines. Self-sharpening and has an extremely long service life.



### Technical Data:

Dimensions (mm)	Suitable for	Pkg. unit	Grit (K)	Article number
170 x 22	ROLEI EF 165, ROLEI PEF 500	1	50	36050
			60	36060
			80	36080
			120	36120

### CHOOSE THE RIGHT GRIT/DISC:

Stainless steel, steel . . . .50 grit/60 grit  
Aluminium, copper, brass .80 grit/120 grit  
Hard plastic . . . . .120 grit



Suitable for

**ALL METALS**

## ROLEI HellFire® Special Flap Disc

Ceramic hybrid disc for particularly high rate of metal removal in one operation. Suitable for larger bevel widths due to its high aggressivity. Coarse to medium application; grinds all metals from steel, stainless steel and titanium through to non-ferrous metals.

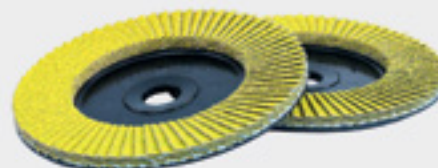

### Technical Data:

Dimensions (mm)	Suitable for	Pkg. unit	Grit (K)	Article number
170 x 22	ROLEI EF 165, ROLEI PEF 500	1	Multigrain 40/60	36046

### CHOOSE THE RIGHT GRIT/DISC:

All metals. . . . . Multigrain 40/60



Suitable for

**ROLEI PEF 500**

# ROLEI PEF 500 Accessory Pack

For bevelling thin sheet metal (name and company badges) from approx. 2.5 mm thickness and as a guidance aid for deburring long square bar material.

### Technical Data:

Description	Suitable for	Pkg. unit	Article number
Thin sheet metal accessory package	ROLEI PEF 500	1	30211

### Contents of Set:

- 1 Roller bar with 9 ball bearings and fixing bolts
- 1 Guide rail with knurled screws
- 1 Angular hand guide from gliding plastic

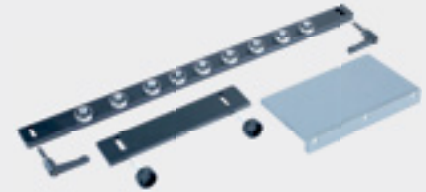

Suitable for

**ROLEI PEF 500**

## ROLEI PEF 500 Machine Stand

Sturdy steel machine stand incl. fixing bolts with black powder coating for working comfortably in a standing position.

### Technical Data:

Dimensions (L x W x H) (mm)	Weight (kg)	Pkg. unit	Article number
505 x 305 x 660	Approx. 20	1	30220



# ROLEI BE 5 Sheet Metal Deburring Machine

The ideal workbench or free-standing tool for the lightning fast deburring of all metals (incl. stainless steel) on both sides up to approx. 5 mm sheet thickness in one operation.



### FEATURES

- Easy to operate (even by support staff)
- 2 speeds available (600 and 1200 rpm)
- Powerful 380 volt three-phase motor for continuous use
- Wear-free aluminium transmission with spindle mounts for replacement tools
- 1 set (2 pcs) grinding flap wheels deburrs approx. 2000 m of sheet stainless steel
- Replacement tools are easy to change
- Suction flange for industrial extractor (internal diameter 35 mm) now supplied as standard
- Wear-free, hardened guide rail (infinitely adjustable)



ROLEI BE 5 deburring tool can also be used on its side with a roller table for larger sections of sheet metal.

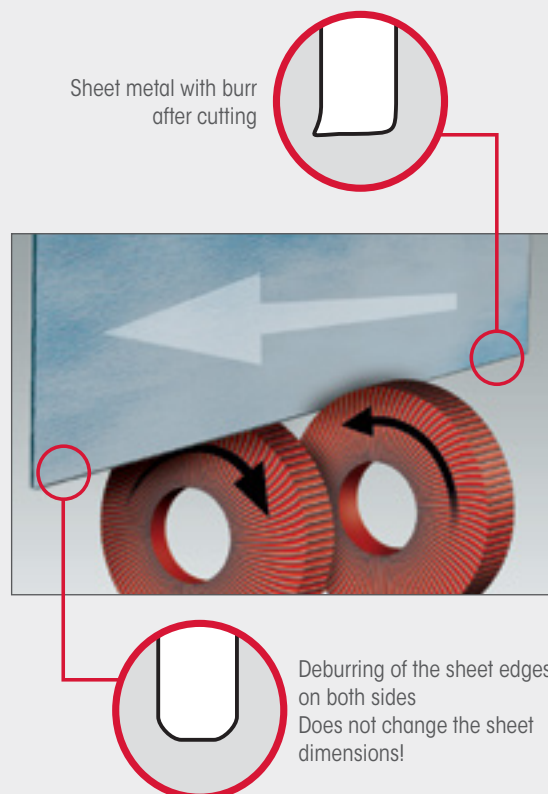

## Technical Data: ROLEI BE 5 Machine

Dimensions (mm)	Plug type	Mains connection (V ~ Hz)	Power (W)	Speed (rpm)	Sheet metal thickness (working mm)	Weight (kg)	Pkg. unit	Article number
700 x 325 x 200	3-phase	380 ~ 50	750	Setting 1: Fine deburring 600 Setting 2: Standard deburring 1200	0 – 5	Approx. 29	1	30310

Accessories included in package: 1 ROLEI BE 5 machine, 2 flap wheels 60 grit

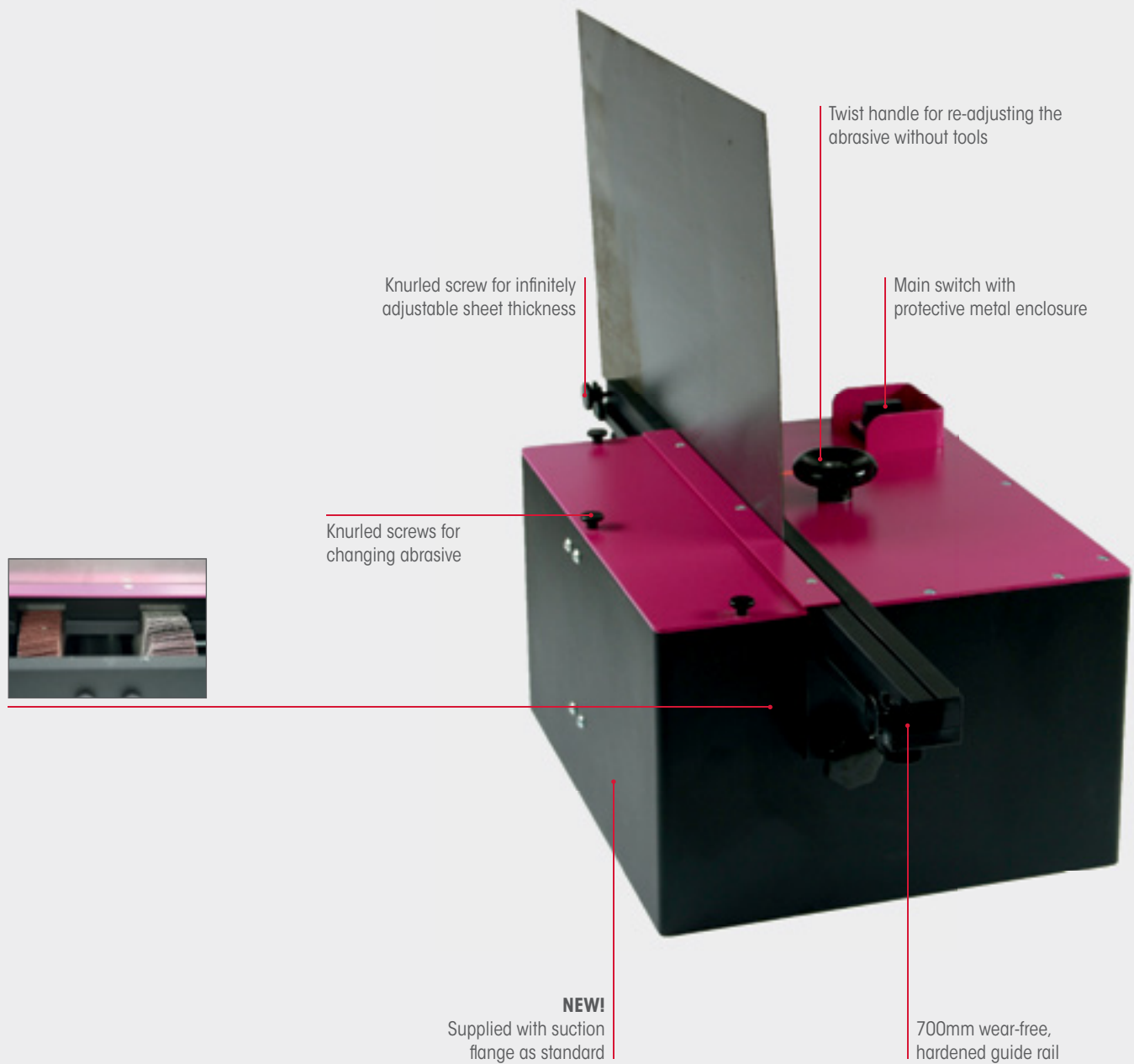



Suitable for

**ROLEI EF 165 · ROLEI PEF 500 · ROLEI BE 5**

## Teflon Strips (self-adhesive)

For the guide rail to protect against scratches on the workpiece/sheets.

### Technical Data:

Dimensions (mm)	Material	Pkg. unit	Article number
20 x 700	Teflon	10	30341



Suitable for

**ALL METALS**

## ROLEI BE 5 Flap Wheel



Replacement grinding flap wheels, in 100 % cotton, for great deburring. Cotton design ensures wheel can be used for a particularly wide range of applications and assures optimum usage of the grinding tools.

### Technical Data:

Dimensions (mm)	Pkg. unit	Grit (K)	Article number
165 x 30	2	40	37040
		60	37060
		80	37080
		120	37120



Suitable for

**ROLEI BE 5**

## **ROLEI BE 5 Machine Stand**

Sturdy steel machine stand with black powder coating for working comfortably in a standing position.

### Technical Data:

Dimensions (L x W x H) (mm)	Weight (kg)	Pkg. unit	Article number
385 x 325 x 660	approx. 20	1	30320





**When  
stainless steel  
is your  
business card!**



# CHEMICALS AND CARE PRODUCTS

## **CLEANING** ..... 210

BRILLIANCE CLEAN ..... 210

## **PROTECTION** ..... 211

INOX PROTECT (dry, hard wax) ..... 211

## **PRESERVE** ..... 212

POLY SEAL (oil film) ..... 212

## **GRINDING ADDITIVES** ..... 213

KANGAROO ALU-FIX OIL ..... 213



Suitable for

**ALL METALS · PAINTED SURFACES · HARD PLASTICS · WOOD · GLASS · ACRYLIC**

## BRILLIANCE CLEAN

Streak-free cleaning

Removes all kinds of minor contaminants lightning fast from all metal such as stainless steel, aluminium, copper, brass, etc. – and glass, wood, hard plastic and much more. Making it look as good as new. Evaporates quickly, leaving all surfaces free of streaks and residues. Particularly suitable for stainless steel surfaces. Also used for all other cleaning jobs – and the quickest and most effective solution in the home. BRILLIANCE CLEAN is completely non-toxic and environmentally friendly. Try it once and you won't want to be without this time-saving cleaning aid again!

### Technical Data:

Packaging	Contents	Pkg. unit	Article number
Spray bottle	50 ml	1	40050m
	500 ml	1	40050
Can	5 liters	1	40051
Larger sizes are available on request			



Suitable for

**ALL METALS**

# INOX PROTECT (dry, hard wax)

Protect and seal

Cleans lightning fast and protects decorative surfaces from, fingerprints and stains long-term with a transparent hard protective layer. Ideal for stainless steel visible surfaces of all kinds, kitchen panelling, lift walls made from stainless steel, railings, rods, pipes, stainless steel tables and much more! Can also be used for all other metals. Spray onto parts and distribute it by rubbing in with a microfibre cloth, then after a few seconds polish using a second dry microfibre cloth. All parts will look completely new and can simply be re-polished dry at any time until it is re-applied.



**Technical Data:**

Packaging	Contents	Pkg. unit	Article number
Spray bottle	50 ml	1	40040m
	500 ml	1	40040
Can	5 liters	1	40041

Larger packs available on request.



Suitable for

**STAINLESS STEEL · NON-FERROUS METALS**

# POLY SEAL (oil film)

Clean and preserve.

**Food-grade** and ideal for decorative outdoor stainless steel surfaces, such as stainless steel doors, cladding, surfaces of railings, fountains, figurines, works of art, large kitchens and catering establishments. Practical spray bottle dispenses the perfect dose and applies the oil effectively (refillable).  
For cleaning and preserving ground and polished surfaces. Finger marks, water marks and shadows remain invisible long-term. Can be used outside and with foodstuffs.



**Technical Data:**

Packaging	Contents	Pkg. unit	Article number
Spray bottle	50 ml	1	40011m
	500 ml	1	40011
Can	5 liters	1	40012

Larger packs available on request.





Suitable for

**ALUMINIUM**

# KANGAROO ALU-FIX OIL

This special unique oil for grinding aluminium prevents flap discs from smearing and increases the service life and performance by up to 300 %.  
Simply spray onto the workpiece before grinding and grind as normal!

## Technical Data:

Packaging	Contents	Pkg. unit	Article number
Spray bottle	50ml	1	40010m
	500 ml	1	40010
Can	5 liters	1	40010k







**The perfect  
accessories  
for the  
perfect tools**

# ACCESSORIES

## ACCESSORIES ..... 215

EASYLOCK Quick Lock Nut . . . . .	216
FIX TEC Quick Release Nut . . . . .	216
Thin Clamping Nut . . . . .	216
Height-Adjusting Washer . . . . .	216
M10 to M14 Adapter . . . . .	216
E-Boxx Case . . . . .	217
POLY-PTX® Professional Transport Case . . . . .	217
Aluminium Transport Case . . . . .	217
Basic Carry Case . . . . .	217
Stainless Steel Cover Plate . . . . .	218
Hand Fleece . . . . .	219
Face Mask . . . . .	219
Grinding Wheel Mount . . . . .	220
Ear Plugs . . . . .	220
Clear Safety Glasses . . . . .	220
BRIGHTEX® Non-Scratch Cloth . . . . .	221
Microfibre Cloth . . . . .	221

## EASYLOCK Quick Lock Nut

For locking discs onto angle grinders quickly and safely without any need for a chuck key or clamp clip. Ideal for Eisenblätter flap discs. Tightens automatically when load is applied.

### Technical Data:

Dimensions (Ø mm)	Mount	Pkg. unit	Article number
45	M14	1	65008
45	5/8"	1	65008-4



## FIX TEC Quick Release Nut

For safely locking discs onto angle grinders without any need for a chuck key with quick clamp clip.

### Technical Data:

Dimensions (Ø mm)	Mount	Pkg. unit	Article number
45	M14	1	65003



## Flat Clamping Nut

Ultra-flat, blackened steel clamping nut (just 4 mm) incl. chuck key for flat flange recesses and tools. For locking tools onto angle grinders.

### Technical Data:

Dimensions (Ø mm)	Mount	Pkg. unit	Article number
45	M14	1	65004



## Height-Adjusting Washer

Height-adjusting washer for adjusting the height of the angle grinder spindle (only for M14) for discs up to Ø 178 mm with extra-long drive spindle. Also enlarges the contact surface.

### Technical Data:

Dimensions (Ø mm)	Mount	Pkg. unit	Article number
50	M14	1	65005



## M10 to M14 Adapter

Screw on the adapter and high-tech European discs can be used on angle grinders produced in Asia.

### Technical Data:

Dimensions	Pkg. unit	Article number
Thread M10 on M14	1	65006



### E-Boxx Case

Very sturdy, shockproof case for equipment and tools with an optional range of foam inserts to protect contents from jolts. Locking mechanism for stacking. Ideal for total protection on site. For a variety of uses!



**Technical Data:**

Article	Dimensions (L x W x H) (mm)	Suitable for	Pkg. unit	Article number
E-Boxx case	490 x 285 x 180	POLY-PTX®, VARILEX®, MINI MAX® PRO, PIPE FIX DUO & SMART, ROLEI EF 115	1	40008a
Foam inlays in 5 sections		E-Boxx case	1	80003sv

### POLY-PTX® Professional Transport Case

Sturdy, shockproof plastic design divided up internally by molded foam inserts for on site and outdoor use. Lockable! Specially made for your POLY-PTX®.



**Technical Data:**

Dimensions (L x W x H) (mm)	Suitable for	Pkg. unit	Article number
515 x 385 x 210	POLY-PTX® machines and accessories	1	80002

### Aluminium Transport Case

Shockproof design with sealed lid. Splashproof! The carry case protects against impact and accommodates one machine and many tools.



**Technical Data:**

Dimensions (L x W x H) (mm)	Suitable for	Pkg. unit	Article number
515 x 330 x 220	POLY-PTX®, VARILEX®, PIPE FIX Smart & DUO, MINI MAX® and ROLEI EF 115	1	50101
760 x 350 x 300	PIPE MAX, PIPE SNIPER® and GLADIUS® 1800	1	50102

### Basic Case

Sturdy, heavy-duty plastic design for use on site.

**Technical Data:**

Dimensions (L x W x H) (mm)	Suitable for	Pkg. unit	Article number
495 x 230 x 205	POLY-PTX®, VARILEX® WSF 1800, MINI MAX® PRO, PIPE FIX DUO & SMART, ROLEI EF 115	1	40008





Suitable for

**PERFECT MITER GRINDING**

## Stainless Steel Cover Plate

For perfectly miter grinding

Stainless steel (1.4301 / 304) produces precision miter edges and is easy to cut. Self-adhesive for fast application and can be removed without leaving any residue. Clean adhesion for perfect miter grinding on all materials.

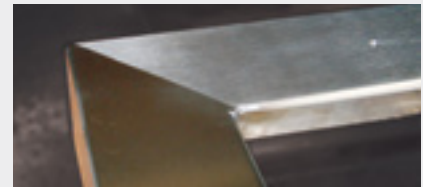

### Technical Data:

Dimensions (mm)	Material thickness (mm)	Material	Pkg. unit	Article number
Ø 150 x 2,500	0.1	Stainless steel (1.4301 / 304)	1	40070



Suitable for

**STEEL · STAINLESS STEEL · NON-FERROUS METALS · WOOD · HARD PLASTICS**

# Hand Fleece

for hard to reach places, such as corners, etc. (supplied on a roll)



Totally ferrite-free (iron). Ideal for stainless steel, wood, steel, non-ferrous metals and hard plastics. High grit density for an extremely long service life and uniform grinding. Supplied on practical 10 m rolls for storing. For shadow-free industrial grinding (matt and satin finish), removing oxide layers and smoothing "ground" sheet metal by hand and in places that are difficult to access.

**Technical Data:**

Width (mm)	Length (m)	Pkg. unit	Grit (K)	Article number
100	10	1	80	60080
			180	60180
			280	60280
			400	60400

# Face Mask

with exhalation valve

Filter class FFP1 protects against solid and liquid particles but not volatile particles and includes an exhalation valve to stop heat and moisture becoming trapped in the face mask. Individually adjustable nose clip for the wearer's comfort and is also ideal for spectacle-wearers. Soft and padded fleece inside with fabric tapes for durability and comfort. The product complies with EN 149:2001. For the safe and approved protection of the airways while working with handheld machines and using all grinding and polishing tools.



**Technical Data:**

Standard	Pkg. unit	Article number
DIN EN 149:2001	10	40100

Suitable for

**DRILLS · STRAIGHT GRINDERS**

## Grinding Wheel Mount



For using up to 50 mm-wide rollers and brushes, etc., for use with drills and straight grinders (shaft diameter 8 mm), for example. Supplied with clamp bolt.

### Technical Data:

Material	Wheel width (mm)	Pkg. unit	Article number
Steel	50	1	65007

## Ear Plugs

Made from environmentally sustainable polyurethane foam that reverts to its original shape. Soft and skin-friendly foam ear plugs that are extremely comfortable to wear. SNR value 37 dB. The product complies with DIN EN 352-2. For the safe and statutory protection of the user's hearing when working with handheld machines and using all grinding and polishing tools.



### Technical Data:

Standard	Packaging	Pkg. unit	Article number
DIN EN 352-2	Re-sealable box (200 pces)	1	40103

## Clear Safety Glasses

with adjustable arms



Adjustable arms with soft, rubberised arms to ensure a perfect fit and be comfortable for the wearer. Unrestricted vision free of distortion due to the top quality (plastic) lenses used. The product complies with DIN EN 166:2001. For the safe and statutory protection of the eyes when working with handheld machines and using all grinding and polishing tools.

### Technical Data:

Material	Standard	Pkg. unit	Article number
Plastic	DIN EN 166:2001	1	40104

Suitable for

**ALL MATERIALS**

# BRIGHTEX<sup>®</sup> Non-Scratch Cloth



Much improved, ultra-soft microfibre cloth, free of seams for scratch-free cleaning of stainless steel surfaces and other decorative metals. Particularly soft and absorbent. Can be washed many times.

## Technical Data:

Dimensions (mm)	Quality	Pkg. unit	Article number
400 x 400	360 g/m <sup>2</sup>	5	40031

Suitable for

**ALL METALS**

# Microfibre Cloth



These microfibre cloths have a lightning-fast pore-deep cleaning effect and evenly distributes cleaning products onto the surface. It can also remove paste and cream residues.

## Technical Data:

Dimensions (mm)	Quality	Pkg. unit	Article number
400 x 400	290 g/m <sup>2</sup>	25	40030



Article number	Description		Pkg. unit	Page
10002	MINI MAX® PRO Machine (EU)	850 watts, 220 – 240 volts	1	107
10003	MINI MAX® PRO Professional Set (EU)	850 watts, 220 – 240 volts	1	108
10008	Machine Holder	for VARILEX® WSF 1800	1	72
10009	Machine Holder	for MINI MAX®, PIPE FIX, VARILEX® WSF 900 DUO	1	77
10010	Flexible Shaft	6 mm shaft, 6 mm collet, 6 mm core reinforcement, 140 cm	1	109
10014	Flexible Shaft	M14 threaded, 6mm collet, 7 mm core reinforcement. 142 cm	1	72
10017	MINI MAX® Clamping Spindle	6 mm steel shaft, for polishing rings and wire wheels	1	102
10019	MINI MAX® Stainless Steel Wire Wheel	60 x 10 mm, 6 mm shaft, wire thickness 0.2 mm	5	104
10020	MINI MAX® Felt Polishing Tip	20 x 25 mm, 6 mm steel shaft, merino, round	10	102
10021	MINI MAX® Felt Polishing Tip	30 x 35 mm, 6 mm steel shaft, merino, cylindrical	10	102
10022	MINI MAX® Felt Polishing Tip	15 x 30 mm, 6 mm steel shaft, merino, conical	10	102
10023	MINI MAX® Stainless Steel Wire Brush	10 x 100 mm, 6 mm steel shaft	5	104
10100	MINI FIX Special Backing Pad	60 mm, 6 mm steel shaft, hook & loop	1	94
10100b	MINI FIX Special Backing Pad	60 mm, M14 thread, hook & loop	1	94
10101	MINI FIX Clean Disc	63 x 13 mm, hook & loop	20	95
10105	MINI FIX Soft Damping Adapter	60 mm, harpoon hook & loop	5	94
10117	MINI FIX Felt Disc	60 x 5 mm, merino, hook & loop	20	98
10117n	MINI FIX SuperPolish Disc	60 x 5 mm, hook & loop	20	98
10118	MINI FIX BRIGHTEX® Berry Polishing Disc	60 x 5 mm, hook & loop	20	97
10119	MINI FIX BRIGHTEX® Sun Polishing Disc	60 x 5 mm, hook & loop	20	97
10134	MINI FIX Cool Top®	63 mm, 40 grit, hook & loop, flap disc	20	95
10136	MINI FIX Cool Top®	63 mm, 60 grit, hook & loop, flap disc	20	95
10138	MINI FIX Cool Top®	63 mm, 80 grit, hook & loop, flap disc	20	95
10139	MINI FIX Cool Top®	63 mm, 120 grit, hook & loop, flap disc	20	95
10141	MINI FIX Trizact™ Disc	60 mm, 220 / A 100 grit, hook & loop	20	96
10142	MINI FIX Trizact™ Disc	60 mm, 280 / A 65 grit, hook & loop	20	96
10143	MINI FIX Trizact™ Disc	60 mm, 400 / A 45 grit, hook & loop	20	96
10144	MINI FIX Trizact™ Disc	60 mm, 600 / A 30 grit, hook & loop	20	96
10145	MINI FIX Trizact™ Disc	60 mm, 1200 / A 16 grit, hook & loop	20	96
10146	MINI FIX Trizact™ Disc	60 mm, 2000 / A 06 grit, hook & loop	20	96
10151	MINI FIX SC Fleece Disc	60 x 10 mm, coarse, hook & loop	20	96
10152	MINI FIX SC Fleece Disc	60 x 10 mm, medium, hook & loop	20	96
10153	MINI FIX SC Fleece Disc	60 x 10 mm, fine, hook & loop	20	96
10154	MINI FIX SC Fleece Disc	60 x 10 mm, superfine, hook & loop	20	96
10201	MINI MAX® Expansion Roller	30 x 30 mm, 6 mm steel shaft	1	99
10202	MINI MAX® Expansion Roller	45 x 30 mm, 6 mm steel shaft	1	99
10214	MINI MAX® Zirconium Sleeve	30 x 30 mm, 40 grit	50	99
10216	MINI MAX® Zirconium Sleeve	30 x 30 mm, 60 grit	50	99
10218	MINI MAX® Zirconium Sleeve	30 x 30 mm, 80 grit	50	99
10224	MINI MAX® Zirconium Sleeve	45 x 30 mm, 40 grit	50	99
10226	MINI MAX® Zirconium Sleeve	45 x 30 mm, 60 grit	50	99
10228	MINI MAX® Zirconium Sleeve	45 x 30 mm, 80 grit	50	99
11040	MINI MAX® Flap Wheel	40 x 10 mm, 40 grit	10	100
11041	MINI MAX® Flap Wheel	60 x 30 mm, 40 grit	10	100
11060	MINI MAX® Flap Wheel	40 x 10 mm, 60 grit	10	100
11061	MINI MAX® Flap Wheel	60 x 30 mm, 60 grit	10	100

Article number	Description		Pkg. unit	Page
11080	MINI MAX® Flap Wheel	40 x 10 mm, 80 grit	10	100
11081	MINI MAX® Flap Wheel	60 x 30 mm, 80 grit	10	100
11100	MINI MAX® Flap Wheel	40 x 10 mm, 100 grit	10	100
11101	MINI MAX® Flap Wheel	60 x 30 mm, 100 grit	10	100
13001	MINI MAX® Fleece Wheel	40 x 20 mm, coarse	10	101
13002	MINI MAX® Fleece Wheel	40 x 20 mm, medium	10	101
13003	MINI MAX® Fleece Wheel	40 x 20 mm, fine	10	101
13004	MINI MAX® Fleece Wheel	40 x 20 mm, superfine	10	101
13010	MINI MAX® Fleece Wheel	40 x 20 mm, extra coarse	10	101
13011	MINI MAX® Fleece Wheel	60 x 30 mm, coarse	10	101
13012	MINI MAX® Fleece Wheel	60 x 30 mm, medium	10	101
13013	MINI MAX® Fleece Wheel	60 x 30 mm, fine	10	101
13014	MINI MAX® Fleece Wheel	60 x 30 mm, superfine	10	101
14080	MINI MAX® Mix Wheel	40 x 20 mm, 80 grit	10	101
14081	MINI MAX® Mix Wheel	60 x 30 mm, 80 grit	10	101
14150	MINI MAX® Mix Wheel	40 x 20 mm, 150 grit	10	101
14151	MINI MAX® Mix Wheel	60 x 30 mm, 150 grit	10	101
14240	MINI MAX® Mix Wheel	40 x 20 mm, 240 grit	10	101
14241	MINI MAX® Mix Wheel	60 x 30 mm, 240 grit	10	101
21040	ZIRCOTEX® Nylon Flat	115 x 22 mm, 40 grit, flap disc	10	50
21050	ZIRCOTEX® Nylon Flat	115 x 22 mm, 50 grit, flap disc	10	50
21060	ZIRCOTEX® Nylon Flat	115 x 22 mm, 60 grit, flap disc	10	50
21080	ZIRCOTEX® Nylon Flat	115 x 22 mm, 80 grit, flap disc	10	50
21120	ZIRCOTEX® Nylon Flat	115 x 22 mm, 120 grit, flap disc	10	50
30100	ROLEI EF 165 Machine	380 volts, 50 Hz (3-phase)	1	196
30101	ROLEI EF 165 Machine (EU)	220 – 240 volts, 50 – 60 Hz	1	196
30110	ROLEI EF 165 Extended Support Table	120 x 700 mm, gliding steel	1	199
30115	ROLEI EF 115 Machine (EU)	1750 watts, 220 – 240 volts	1	193
30116	ROLEI EF 115 Machine (GB)	1710 watts, 110 volts	1	193
30117	ROLEI EF 115 Plastic Replacement Guide Rail	(1 set = 2 pcs)	1	194
30120	ROLEI EF 165 Machine Stand	245 x 215 x 660 mm, incl. bolts	1	199
30200	ROLEI PEF 500 Machine	380 volts, 50 Hz (3-phase)	1	201
30201	ROLEI PEF 500 Machine (EU)	220 – 240 volts, 50 – 60 Hz	1	201
30211	ROLEI PEF 500 Accessory Pack	for thin sheet metalworking	1	203
30220	ROLEI PEF 500 Machine Stand	505 x 305 x 660 mm, incl. bolts	1	203
30310	ROLEI BE 5 Machine	380 volts, 50 Hz (3-phase)	1	205
30320	ROLEI BE 5 Machine Stand	385 x 325 x 660 mm, incl. bolts	1	207
30341	ROLEI Teflon Strips	20 x 700 mm, self-adhesive	1	206
30400	MULTI MAX® Professional Set	750 watts, 380 volts, 50 Hz (3-phase)	1	112
30404	MULTI MAX® Machine	750 watts, 380 volts, 50 Hz (3-phase)	1	111
30420	MULTI MAX® Machine Stand	400 x 350 x 830 mm, incl. bolts	1	113
36046	ROLEI HellFire® Special Flap Disc	170 x 22 mm, Multigrain 40/60	1	198
36050	ROLEI Special Flap Disc	170 x 22 mm, 50 grit	1	198
36060	ROLEI Special Flap Disc	170 x 22 mm, 60 grit	1	198
36080	ROLEI Special Flap Disc	170 x 22 mm, 80 grit	1	198
36120	ROLEI Special Flap Disc	170 x 22 mm, 120 grit	1	198

Article number	Description		Pkg. unit	Page
37040	ROLEI BE 5 Flap Wheel	165 x 30 mm, 40 grit	2	206
37060	ROLEI BE 5 Flap Wheel	165 x 30 mm, 60 grit	2	206
37080	ROLEI BE 5 Flap Wheel	165 x 30 mm, 80 grit	2	206
37120	ROLEI BE 5 Flap Wheel	165 x 30 mm, 120 grit	2	206
38002	PIPE FIX DUO Machine (EU)	850 watts, 220 – 240 volts	1	175
38004	PIPE FIX DUO Metal Set (EU)	850 watts, 220 – 240 volts	1	176
38005	PIPE FIX DUO Belt Filing Accessory Pack	Belt filing attachment	1	177
38010	PIPE FIX DUO Flat Filing Attachment		1	177
38011	PIPE FIX DUO Replacement Plate		1	177
38052	PIPE FIX Smart Machine (EU)	850 watts, 220 – 240 volts	1	179
38053	PIPE FIX Smart Metal Set (EU)	850 watts, 220 – 240 volts	1	180
38111	PIPE FIX DUO SC Fleece Sleeve	60 x 260 mm, medium	4	162
38112	PIPE FIX DUO SC Fleece Sleeve	60 x 260 mm, fine	4	162
38113	PIPE FIX DUO SC Fleece Sleeve	60 x 260 mm, superfine	4	162
38114	PIPE FIX DUO Felt Sleeve	60 x 260 mm, merino	4	166
38114n	PIPE FIX DUO SuperPolish Sleeve	60 x 260 mm	4	166
38126	PIPE FIX DUO Corundum Grinding Sleeve	60 x 260 mm, grit 60	10	157
38128	PIPE FIX DUO Corundum Grinding Sleeve	60 x 260 mm, grit 80	10	157
38129	PIPE FIX DUO Corundum Grinding Sleeve	60 x 260 mm, grit 120	10	157
38206	PIPE FIX DUO Trizact™ Sleeve	60 x 260 mm, grit 2000 / A 06	10	161
38216	PIPE FIX DUO Trizact™ Sleeve	60 x 260 mm, grit 1200 / A 16	10	161
38230	PIPE FIX DUO Trizact™ Sleeve	60 x 260 mm, grit 600 / A30	10	161
38245	PIPE FIX DUO Trizact™ Sleeve	60 x 260 mm, grit 400 / A 45	10	161
38265	PIPE FIX DUO Trizact™ Sleeve	60 x 260 mm, grit 280 / A 65	10	161
38270	PIPE FIX DUO Trizact™ Sleeve	60 x 260 mm, grit 220 / A 100	10	161
38501	PIPE MAX Machine (EU)	1750 watts, 220 – 240 volts	1	171
38501a	PIPE MAX Machine (UK)	1710 watts, 110 volts	1	171
38501s	PIPE MAX Machine (CH)	1750 watts, 220 – 240 volts	1	171
38501u	PIPE MAX Machine (US)	1710 watts, 120 volts	1	171
38502	PIPE MAX Metal Set (EU)	1750 watts, 220 – 240 volts	1	172
38502a	PIPE MAX Metal Set (UK)	1710 watts, 110 volts	1	172
38502s	PIPE MAX Metal Set (CH)	1750 watts, 220 – 240 volts	1	172
38502u	PIPE MAX Metal Set (US)	1710 watts, 120 volts	1	172
38520	Special HellFire® Belt	40 x 780 mm, Multigrain 40/60	10	155
38524	Special Zirconium Belt	40 x 780 mm, 40 grit	10	155
38526	Special Zirconium Belt	40 x 780 mm, 60 grit	10	155
38528	Special Zirconium Belt	40 x 780 mm, 80 grit	10	155
38529	Special Zirconium Belt	40 x 780 mm, 120 grit	10	155
38531	Special SC Fleece Belt	40 x 780 mm, coarse	4	159
38532	Special SC Fleece Belt	40 x 780 mm, medium	4	159
38533	Special SC Fleece Belt	40 x 780 mm, fine	4	159
38534	Special SC Fleece Belt	40 x 780 mm, superfine	4	159
38544	Special Trizact™ Belt	40 x 780 mm, 220 / A 100 grit	10	158
38545	Special Trizact™ Belt	40 x 780 mm, 280 / A 65 grit	10	158
38546	Special Trizact™ Belt	40 x 780 mm, 400 / A 45 grit	10	158
38547	Special Trizact™ Belt	40 x 780 mm, 600 / A 30 grit	10	158

Article number	Description		Pkg. unit	Page
38548	Special Trizact™ Belt	40 x 780 mm, 1200 / A 16 grit	10	158
38550	Special SuperPolish Belt	40 x 780 mm	4	164
38551	BRIGHTEX® Berry Special Polishing Belt	40 x 780 mm	4	163
38552	BRIGHTEX® Sun Special Polishing Belt	40 x 780 mm	4	163
38601	PIPE SNIPER® Machine (EU)	1750 watts, 220 – 240 volts	1	183
38601a	PIPE SNIPER® Machine (UK)	1710 watts, 110 volts	1	183
38601s	PIPE SNIPER® Machine (CH)	1750 watts, 220 – 240 volts	1	183
38601u	PIPE SNIPER® Machine (US)	1710 watts, 120 volts	1	183
38602	PIPE SNIPER® Metal Set (EU)	1750 watts, 220 – 240 volts	1	184
38602a	PIPE SNIPER® Metal Set (UK)	1710 watts, 110 volts	1	184
38602s	PIPE SNIPER® Metal Set (CH)	1750 watts, 220 – 240 volts	1	184
38602u	PIPE SNIPER® Metal Set (US)	1710 watts, 120 volts	1	184
38651	GLADIUS® 1800 Machine (EU)	1750 watts, 220 – 240 volts	1	187
38651a	GLADIUS® 1800 Machine (UK)	1710 watts, 110 volts	1	187
38651s	GLADIUS® 1800 Machine (CH)	1750 watts, 220 – 240 volts	1	187
38651u	GLADIUS® 1800 Machine (US)	1710 watts, 120 volts	1	187
38652	GLADIUS® 1800 Metal Set (EU)	1750 watts, 220 – 240 volts	1	188
38652a	GLADIUS® 1800 Metal Set (UK)	1710 watts, 110 volts	1	188
38652s	GLADIUS® 1800 Metal Set (CH)	1750 watts, 220 – 240 volts	1	188
38652u	GLADIUS® 1800 Metal Set (US)	1710 watts, 120 volts	1	188
38660	GLADIUS® 1800 Equipment Stand	Heavy-duty and sturdy design	1	189
40002	POLY-PTX® 800 Machine (EU)	1750 watts, 220 – 240 volts, incl. fleece wheel	1	141
40002a	POLY-PTX® 800 Machine (UK)	1710 watts, 110 – 240 volts, incl. fleece wheel	1	141
40002j	POLY-PTX® 800 Machine (JP)	1710 watts, 110 – 240 volts, incl. fleece wheel	1	141
40002s	POLY-PTX® 800 Machine (CH)	1750 watts, 220 – 240 volts, incl. fleece wheel	1	141
40003	POLY-PTX® 800 Metal Set (EU)	1750 watts, 220 – 240 volts	1	143
40003-5	POLY-PTX® 800 Professional Set (EU)	1750 watts, 220 – 240 volts	1	142
40003-5a	POLY-PTX® 800 Professional Set (UK)	1710 watts, 110 volts	1	142
40003-5j	POLY-PTX® 800 Professional Set (JP)	1710 watts, 110 volts	1	142
40003-5s	POLY-PTX® 800 Professional Set (CH)	1750 watts, 220 – 240 volts	1	142
40003a	POLY-PTX® 800 Metal Set (UK)	1710 watts, 110 volts	1	143
40003j	POLY-PTX® 800 Metal Set (JP)	1710 watts, 110 volts	1	143
40003s	POLY-PTX® 800 Metal Set (CH)	1750 watts, 220 – 240 volts	1	143
40004	POLY-PTX® 800 Wood Set (EU)	1750 watts, 220 – 240 volts	1	144
40004a	POLY-PTX® 800 Wood Set (UK)	1710 watts, 110 volts	1	144
40004j	POLY-PTX® 800 Wood Set (JP)	1710 watts, 110 volts	1	144
40004s	POLY-PTX® 800 Wood Set (CH)	1750 watts, 220 – 240 volts	1	144
40005	POLY-PTX® Aluminium Suction Cover	incl. bolts	1	149
40006va	POLY-PTX® Grinding Belt Roller	85 x 70 mm	1	146
40007	POLY-PTX® Spacer Ring Set	Contents: 2 x 20 mm, 1 x 50 mm, 1 x 10 mm	1	150
40008	Basic Carry Case	Sturdy, excl. contents	1	217
40008a	E-Boxx Case	Sturdy, excl. contents	1	217
40009	Mini Polishing Pastes	Approx. 120 g (60g white + 60g blue)	1	65
40010	KANGAROO ALU-FIX OIL	500 ml spray bottle	1	213
40010k	KANGAROO ALU-FIX OIL	5 L can	1	213
40010m	KANGAROO ALU-FIX OIL	50 ml spray bottle	1	213



Article number	Description		Pkg. unit	Page
40011	POLY SEAL	500 ml spray bottle	1	212
40011m	POLY SEAL	50 ml spray bottle	1	212
40012	POLY SEAL	5 L can	1	212
40013	White Pre-Polishing Paste	Approx. 650 g	1	65
40014	Blue Final-Polishing Paste	Approx. 650 g	1	65
40015	Pink Polishing Cream	Approx. 1 kg tin	1	65
40015f	Pink Polishing Cream	Approx. 60 ml tube	1	65
40017	POLY-PTX® Felt Wheel	100 x 50 mm, merino	4	130
40018	POLY-PTX® Clean Wheel	115 x 110 mm	2	135
40018a	POLY-PTX® Clean Wheel	115 x 50 mm	4	135
40018w	POLY-PTX® Clean Wheel Soft	115 x 100 mm	2	136
40019	POLY-PTX® Cotton Ring	Impregnated, 100 x 10 mm, main polish for non-ferrous metals	8	130
40019m	POLY-PTX® Mirror Finishing Ring Medium	100 x 10 mm, main polish for stainless steel	8	131
40019f	POLY-PTX® Mirror Finishing Ring Soft	100 x 10 mm, final polish for stainless steel/non-ferrous metals	8	131
40025	BRIGHTEX® Berry Pre-Polishing Paste	Contents: 1100 g	1	63
40026	BRIGHTEX® Sun post-Polishing Paste	Contents: 1300 g	1	63
40028	BRIGHTEX® Softclean Powder	Approx. 1 kg in a resealable bag	1	64
40029	BRIGHTEX® Softclean Powder	Approx. 200 g, aluminium shaker	1	64
40030	Microfibre Cloth	400 x 400 mm (1 set = 25 pces)	25	65
40031	BRIGHTEX® Non-Scratch Cloth	Approx. 400 x 400 mm (1 pack = 5 pces)	5	64
40040	INOX PROTECT (dry, hard wax)	500 ml spray bottle	1	211
40040m	INOX PROTECT (dry, hard wax)	50 ml spray bottle	1	211
40041	INOX PROTECT (dry, hard wax)	5 L can	1	211
40050	BRILLIANCE CLEAN	500 ml spray bottle	1	210
40050m	BRILLIANCE CLEAN	50 ml spray bottle	1	210
40051	BRILLIANCE CLEAN	5 L can	1	210
40070	Stainless Steel Cover Plate	150 x 2500 mm, 0.1 mm material thickness, self-adhesive	1	218
40080	POLY-PTX® Special Bar Handle	incl. fixing bolts	1	150
40100	Face Mask	With exhalation valve, DIN EN 149:2001	10	219
40103	Ear Plugs	100 set, 200 pces, DIN EN 352-2, SNR 37 dB	1	220
40104	Clear Safety Glasses	with adjustable arms, DIN EN 166:2001, not tinted	1	220
41040	POLY-PTX® Flap Wheel	105 x 50 mm, 40 grit	4	118
41060	POLY-PTX® Flap Wheel	105 x 50 mm, 60 grit	4	118
41080	POLY-PTX® Flap Wheel	105 x 50 mm, 80 grit	4	118
41120	POLY-PTX® Flap Wheel	105 x 50 mm, 120 grit	4	118
41180	POLY-PTX® Flap Wheel	105 x 50 mm, 180 grit	4	118
41240	POLY-PTX® Flap Wheel	105 x 50 mm, 240 grit	4	118
41440	POLY-PTX® Flap Wheel	105 x 100 mm, 40 grit	4	118
41460	POLY-PTX® Flap Wheel	105 x 100 mm, 60 grit	4	118
41480	POLY-PTX® Flap Wheel	105 x 100 mm, 80 grit	4	118
41490	POLY-PTX® Flap Wheel	105 x 100 mm, 120 grit	4	118
41491	POLY-PTX® Flap Wheel	105 x 100 mm, 180 grit	4	118
42001	POLY-PTX® Expansion Roller	90 x 50 mm	1	145
42002	POLY-PTX® Expansion Roller	90 x 100 mm	1	145
42003	POLY-PTX® Inflatable Expansion Roller	90 x 100 mm	1	145
42004	POLY-PTX® Eco Smart Adapter	45 x 100 mm	1	147

Article number	Description		Pkg. unit	Page
42009	POLY-PTX® SC Fleece Sleeve	90 x 100 mm, superfine	4	122
42010	POLY-PTX® SC Fleece Sleeve	90 x 100 mm, coarse	4	122
42011	POLY-PTX® SC Fleece Sleeve	90 x 100 mm, medium	4	122
42012	POLY-PTX® SC Fleece Sleeve	90 x 100 mm, fine	4	122
42013	POLY-PTX® Felt Sleeve	90 x 100 mm, merino	4	129
42013n	POLY-PTX® SuperPolish Sleeve	90 x 100 mm	4	129
42014	POLY-PTX® BRIGHTEX® Berry Polishing Sleeve	90 x 100 mm	2	128
42015	POLY-PTX® BRIGHTEX® Sun Polishing Sleeve	90 x 100 mm	2	128
42040	POLY-PTX® Zirconium Sleeve	90 x 100 mm, 40 grit	10	117
42060	POLY-PTX® Zirconium Sleeve	90 x 100 mm, 60 grit	10	117
42080	POLY-PTX® Zirconium Sleeve	90 x 100 mm, 80 grit	10	117
42120	POLY-PTX® Zirconium Sleeve	90 x 100 mm, 120 grit	10	117
42150	POLY-PTX® Zirconium Sleeve	90 x 100 mm, 150 grit	10	117
42180	POLY-PTX® Zirconium Sleeve	90 x 100 mm, 180 grit	10	117
42206	POLY-PTX® Trizact™ Sleeve	90 x 100 mm, 2000 / A 06 grit	10	121
42216	POLY-PTX® Trizact™ Sleeve	90 x 100 mm, 1200 / A 16 grit	10	121
42230	POLY-PTX® Trizact™ Sleeve	90 x 100 mm, 600 / A 30 grit	10	121
42245	POLY-PTX® Trizact™ Sleeve	90 x 100 mm, 400 / A 45 grit	10	121
42265	POLY-PTX® Trizact™ Sleeve	90 x 100 mm, 280 / A 65 grit	10	121
42270	POLY-PTX® Trizact™ Sleeve	90 x 100 mm, 220 / A 100 grit	10	121
42280	POLY-PTX® Trizact™ Sleeve	90 x 100 mm, 120 / A 160 grit	10	121
42301	POLY-PTX® Zirconium Sleeve	90 x 50 mm, 40 grit	10	117
42302	POLY-PTX® Zirconium Sleeve	90 x 50 mm, 60 grit	10	117
42303	POLY-PTX® Zirconium Sleeve	90 x 50 mm, 80 grit	10	117
42304	POLY-PTX® Zirconium Sleeve	90 x 50 mm, 120 grit	10	117
42305	POLY-PTX® Zirconium Sleeve	90 x 50 mm, 150 grit	10	117
42306	POLY-PTX® Zirconium Sleeve	90 x 50 mm, 180 grit	10	117
42311	POLY-PTX® SC Fleece Sleeve	90 x 50 mm, coarse	4	122
42312	POLY-PTX® SC Fleece Sleeve	90 x 50 mm, medium	4	122
42313	POLY-PTX® SC Fleece Sleeve	90 x 50 mm, fine	4	122
42314	POLY-PTX® SC Fleece Sleeve	90 x 50 mm, superfine	4	122
42321	POLY-PTX® Trizact™ Sleeve	90 x 50 mm, 2000 / A 06 grit	10	121
42322	POLY-PTX® Trizact™ Sleeve	90 x 50 mm, 1200 / A 16 grit	10	121
42323	POLY-PTX® Trizact™ Sleeve	90 x 50 mm, 600 / A 30 grit	10	121
42324	POLY-PTX® Trizact™ Sleeve	90 x 50 mm, 400 / A 45 grit	10	121
42325	POLY-PTX® Trizact™ Sleeve	90 x 50 mm, 280 / A 65 grit	10	121
42326	POLY-PTX® Trizact™ Sleeve	90 x 50 mm, 220 / A 100 grit	10	121
42327	POLY-PTX® Trizact™ Sleeve	90 x 50 mm, 120 / A 160 grit	10	121
42331	POLY-PTX® SuperPolish Sleeve	90 x 50 mm	4	129
42332	POLY-PTX® BRIGHTEX® Berry Polishing Sleeve	90 x 50 mm	4	128
42333	POLY-PTX® BRIGHTEX® Sun Polishing Sleeve	90 x 50 mm	4	128
42440	POLY-PTX® Ceramic Sleeve	90 x 100 mm, 40 grit	10	116
42460	POLY-PTX® Ceramic Sleeve	90 x 100 mm, 60 grit	10	116
42480	POLY-PTX® Ceramic Sleeve	90 x 100 mm, 80 grit	10	116
42540	HellFire® Ceramic hybrid Sleeve	90 x 100 mm, 40 grit	10	116
42560	HellFire® Ceramic hybrid Sleeve	90 x 100 mm, 60 grit	10	116

Article number	Description		Pkg. unit	Page
43004	POLY-PTX® Cut & Polish (S/C) Fleece Wheel	115 x 100 mm, 240-280 grit	2	119
43060	POLY-PTX® Fleece Wheel	115 x 50 mm, 60 grit	4	124
43060a	POLY-PTX® Fleece Wheel	105 x 50 mm, 60 grit	4	124
43061	POLY-PTX® Fleece Wheel	115 x 110 mm, 60 grit	4	124
43061a	POLY-PTX® Fleece Wheel	105 x 100 mm, 60 grit	4	124
43100	POLY-PTX® Fleece Wheel	115 x 50 mm, 80 grit	4	124
43100a	POLY-PTX® Fleece Wheel	105 x 50 mm, 80 grit	4	124
43101	POLY-PTX® Fleece Wheel	115 x 110 mm, 80 grit	4	124
43101a	POLY-PTX® Fleece Wheel	105 x 100 mm, 80 grit	4	124
43102	POLY-PTX® Fleece Top Wheel	112 x 100 mm, 80 grit	2	125
43103	POLY-PTX® Fleece Top Wheel	112 x 100 mm, 180 grit	2	125
43104	POLY-PTX® Fleece Top Wheel	112 x 100 mm, 280 grit	2	125
43105	POLY-PTX® Fleece Top Wheel	112 x 100 mm, 400 grit	2	125
43106	POLY-PTX® Fleece Top Wheel	112 x 100 mm, 600 grit	2	125
43107	POLY-PTX® Fleece Top Wheel	112 x 100 mm, 900 grit	2	125
43180	POLY-PTX® Fleece Wheel	115 x 50 mm, 180 grit	4	124
43180a	POLY-PTX® Fleece Wheel	105 x 50 mm, 180 grit	4	124
43181	POLY-PTX® Fleece Wheel	115 x 110 mm, 180 grit	4	124
43181a	POLY-PTX® Fleece Wheel	105 x 100 mm, 180 grit	4	124
43280	POLY-PTX® Fleece Wheel	115 x 50 mm, 280 grit	4	124
43280a	POLY-PTX® Fleece Wheel	105 x 50 mm, 280 grit	4	124
43281	POLY-PTX® Fleece Wheel	115 x 100 mm, 280 grit	4	124
43281a	POLY-PTX® Fleece Wheel	105 x 100 mm, 280 grit	4	124
43400	POLY-PTX® Fleece Wheel	115 x 50 mm, 400 grit	4	124
43401	POLY-PTX® Fleece Wheel	115 x 100 mm, 400 grit	4	124
43401a	POLY-PTX® Fleece Wheel	105 x 100 mm, 400 grit	4	124
43600	POLY-PTX® Fleece Wheel	115 x 50 mm, 600 grit	4	124
43601	POLY-PTX® Fleece Wheel	115 x 100 mm, 600 grit	4	124
43901	POLY-PTX® Fleece Wheel	115 x 100 mm, 900 grit	4	124
44060	POLY-PTX® Mix Wheel	115 x 50 mm, 60 grit	4	123
44060a	POLY-PTX® Mix Wheel	105 x 50 mm, 60 grit	4	123
44061	POLY-PTX® Mix Wheel	115 x 100 mm, 60 grit	4	123
44061a	POLY-PTX® Mix Wheel	105 x 100 mm, 60 grit	4	123
44100	POLY-PTX® Mix Wheel	115 x 50 mm, 80 grit	4	123
44100a	POLY-PTX® Mix Wheel	105 x 50 mm, 80 grit	4	123
44101	POLY-PTX® Mix Wheel	115 x 100 mm, 80 grit	4	123
44101a	POLY-PTX® Mix Wheel	105 x 100 mm, 80 grit	4	123
44120	POLY-PTX® Mix Wheel	115 x 50 mm, 120 grit	4	123
44120a	POLY-PTX® Mix Wheel	105 x 50 mm, 120 grit	4	123
44121	POLY-PTX® Mix Wheel	115 x 100 mm, 120 grit	4	123
44121a	POLY-PTX® Mix Wheel	105 x 100 mm, 120 grit	4	123
44180	POLY-PTX® Mix Wheel	115 x 50 mm, 180 grit	4	123
44180a	POLY-PTX® Mix Wheel	105 x 50 mm, 180 grit	4	123
44181	POLY-PTX® Mix Wheel	115 x 100 mm, 180 grit	4	123
44181a	POLY-PTX® Mix Wheel	105 x 100 mm, 180 grit	4	123
45060	POLY-PTX® Gum Wheel	105 x 50 mm, 60 grit	4	119

Article number	Description		Pkg. unit	Page
45061	POLY-PTX® Gum Wheel	105 x 100 mm, 60 grit	2	119
45180	POLY-PTX® Gum Wheel	105 x 50 mm, 180 grit	4	119
45181	POLY-PTX® Gum Wheel	105 x 100 mm, 180 grit	2	119
46101	POLY-PTX® Bristle Wheel	100 x 70 mm, bristle thickness 1.27 mm	1	138
46102	POLY-PTX® Bristle Wheel	100 x 12 mm, bristle thickness 1.27 mm	8	138
46102n	POLY-PTX® Bristle Wheel	100 x 25 mm, bristle thickness 1.27 mm	4	138
46201	POLY-PTX® Stainless Steel Wire Wheel	100 x 70 mm, stainless steel wire thickness 0.2 mm	1	137
46202	POLY-PTX® Stainless Steel Wire Wheel	100 x 12 mm, stainless steel wire thickness 0.2 mm	8	137
46202n	POLY-PTX® Stainless Steel Wire Wheel	100 x 25 mm, stainless steel wire thickness 0.2 mm	4	137
46301	POLY-PTX® Wire Wheel	100 x 70 mm, wire thickness 0.27 mm	1	137
46302	POLY-PTX® Wire Wheel	100 x 12 mm, wire thickness 0.27 mm	8	137
46302n	POLY-PTX® Wire Wheel	100 x 25 mm, wire thickness 0.27 mm	4	137
46400	POLY-PTX® Fibre Wheel	100 x 100 mm, fibre thickness 0.4 mm	1	138
47002a	POLY-PTX® 800 Machine (US)	1710 watts, 120 volts, incl. fleece wheel	1	141
47003-5a	POLY-PTX® 800 Professional Set (US)	1710 watts, 120 volts	1	142
47003a	POLY-PTX® 800 Metal Set (US)	1710 watts, 120 volts	1	143
47004a	POLY-PTX® 800 Wood Set (US)	1710 watts, 120 volts	1	144
47005	POLY-PTX® Eco Smart Expansion Roller	90 x 100 mm	1	148
47006	POLY-PTX® Eco Smart Grinding Belt Roller	85 x 70 mm	1	148
47201	POLY-PTX® Eco Smart Flap Wheel	105 x 50 mm, 24 grit	4	120
47202	POLY-PTX® Eco Smart Flap Wheel	105 x 50 mm, 40 grit	4	120
47203	POLY-PTX® Eco Smart Flap Wheel	105 x 50 mm, 50 grit	4	120
47204	POLY-PTX® Eco Smart Flap Wheel	105 x 50 mm, 60 grit	4	120
47205	POLY-PTX® Eco Smart Flap Wheel	105 x 50 mm, 80 grit	4	120
47206	POLY-PTX® Eco Smart Flap Wheel	105 x 50 mm, 120 grit	4	120
47207	POLY-PTX® Eco Smart Flap Wheel	105 x 50 mm, 180 grit	4	120
47208	POLY-PTX® Eco Smart Flap Wheel	105 x 50 mm, 240 grit	4	120
47211	POLY-PTX® Eco Smart Flap Wheel	105 x 100 mm, 40 grit	4	120
47212	POLY-PTX® Eco Smart Flap Wheel	105 x 100 mm, 60 grit	4	120
47213	POLY-PTX® Eco Smart Flap Wheel	105 x 100 mm, 80 grit	4	120
47214	POLY-PTX® Eco Smart Flap Wheel	105 x 100 mm, 120 grit	4	120
47215	POLY-PTX® Eco Smart Flap Wheel	105 x 100 mm, 180 grit	4	120
47301	POLY-PTX® Eco Smart Mix Wheel	105 x 50 mm, 60 grit	4	126
47302	POLY-PTX® Eco Smart Mix Wheel	105 x 50 mm, 80 grit	4	126
47303	POLY-PTX® Eco Smart Mix Wheel	105 x 50 mm, 180 grit	4	126
47311	POLY-PTX® Eco Smart Mix Wheel	105 x 100 mm, 60 grit	4	126
47312	POLY-PTX® Eco Smart Mix Wheel	105 x 100 mm, 80 grit	4	126
47313	POLY-PTX® Eco Smart Mix Wheel	105 x 100 mm, 180 grit	4	126
47322	POLY-PTX® Eco Smart Mix Wheel	105 x 150 mm, 80 grit, extra wide	2	126
47323	POLY-PTX® Eco Smart Mix Wheel	105 x 150 mm, 180 grit, extra wide	2	126
47401	POLY-PTX® Eco Smart Fleece Wheel	105 x 50 mm, 60 grit	4	127
47402	POLY-PTX® Eco Smart Fleece Wheel	105 x 50 mm, 80 grit	4	127
47403	POLY-PTX® Eco Smart Fleece Wheel	105 x 50 mm, 180 grit	4	127
47404	POLY-PTX® Eco Smart Fleece Wheel	105 x 50 mm, 280 grit	4	127
47405	POLY-PTX® Eco Smart Fleece Wheel	105 x 50 mm, 400 grit	4	127
47411	POLY-PTX® Eco Smart Fleece Wheel	105 x 100 mm, 60 grit	4	127



Article number	Description		Pkg. unit	Page
47412	POLY-PTX® Eco Smart Fleece Wheel	105 x 100 mm, 80 grit	4	127
47413	POLY-PTX® Eco Smart Fleece Wheel	105 x 100 mm, 180 grit	4	127
47414	POLY-PTX® Eco Smart Fleece Wheel	105 x 100 mm, 280 grit	4	127
47415	POLY-PTX® Eco Smart Fleece Wheel	105 x 100 mm, 400 grit	4	127
47422	POLY-PTX® Eco Smart Fleece Wheel	105 x 150 mm, 80 grit, extra wide	2	127
47423	POLY-PTX® Eco Smart Fleece Wheel	105 x 150 mm, 180 grit, extra wide	2	127
49000	POLY-PTX® Special Adhesive Tape	25 mm wide, 50 m long	1	151
49001	POLY-PTX® SC Fleece Belt	30 x 660 mm, coarse, T-lock	5	160
49002	POLY-PTX® SC Fleece Belt	30 x 660 mm, medium, T-lock	5	160
49003	POLY-PTX® SC Fleece Belt	30 x 660 mm, fine, T-lock	5	160
49004	POLY-PTX® Felt Belt	30 x 660 mm, T-lock, merino	5	165
49004n	POLY-PTX® SuperPolish Belt	30 x 650 mm	5	164
49005	POLY-PTX® BRIGHTEX® Berry Polishing Belt	30 x 650 mm	4	163
49006	POLY-PTX® BRIGHTEX® Sun Polishing Belt	30 x 650 mm	4	163
49007	POLY-PTX® SC Fleece Belt	30 x 660 mm, superfine, T-lock	5	160
49011s	SC Fleece Belt (Narrow)	9 x 533 mm, medium	10	159
49012s	SC Fleece Belt (Narrow)	9 x 533 mm, fine	10	159
49015	Felt Belt (Narrow)	9 x 533 mm, merino	10	165
49024	Corundum Grinding Belt (Narrow)	9 x 533 mm, 40 grit	10	156
49026	Corundum Grinding Belt (Narrow)	9 x 533 mm, 60 grit	10	156
49028	Corundum Grinding Belt (Narrow)	9 x 533 mm, 80 grit	10	156
49029	Corundum Grinding Belt (Narrow)	9 x 533 mm, 120 grit	10	156
49034	Trizact™ Belt (Narrow)	9 x 533 mm, 220 / A 100 grit	10	158
49035	Trizact™ Belt (Narrow)	9 x 533 mm, 280 / A 65 grit	10	158
49036	Trizact™ Belt (Narrow)	9 x 533 mm, 400 / A 45 grit	10	158
49037	Trizact™ Belt (Narrow)	9 x 533 mm, 600 / A 30 grit	10	158
49038	Trizact™ Belt (Narrow)	9 x 533 mm, 1200 / A 16 grit	10	158
49039	Trizact™ Belt (Narrow)	9 x 533 mm, 2000 / A 06 grit	10	158
49040	POLY-PTX® Corundum Grinding Belt	30 x 600 mm, 40 grit	10	156
49060	POLY-PTX® Corundum Grinding Belt	30 x 600 mm, 60 grit	10	156
49080	POLY-PTX® Corundum Grinding Belt	30 x 600 mm, 80 grit	10	156
49120	POLY-PTX® Corundum Grinding Belt	30 x 600 mm, 120 grit	10	156
49150	POLY-PTX® Corundum Grinding Belt	30 x 600 mm, 150 grit	10	156
49180	POLY-PTX® Corundum Grinding Belt	30 x 600 mm, 180 grit	10	156
49240	POLY-PTX® Corundum Grinding Belt	30 x 600 mm, 240 grit	10	156
49306	POLY-PTX® Trizact™ Belt	30 x 600 mm, 2000 / A 06 grit	10	158
49316	POLY-PTX® Trizact™ Belt	30 x 600 mm, 1200 / A 16 grit	10	158
49330	POLY-PTX® Trizact™ Belt	30 x 600 mm, 600 / A 30 grit	10	158
49345	POLY-PTX® Trizact™ Belt	30 x 600 mm, 400 / A 45 grit	10	158
49365	POLY-PTX® Trizact™ Belt	30 x 600 mm, 280 / A 65 grit	10	158
49370	POLY-PTX® Trizact™ Belt	30 x 600 mm, 220 / A 100 grit	10	158
49504	Corundum Grinding Belt (Narrow)	5 x 533 mm, 40 grit	10	156
49506	Corundum Grinding Belt (Narrow)	5 x 533 mm, 60 grit	10	156
49508	Corundum Grinding Belt (Narrow)	5 x 533 mm, 80 grit	10	156
49509	Corundum Grinding Belt (Narrow)	5 x 533 mm, 120 grit	10	156
49514	Corundum Grinding Belt (Narrow)	3 x 533 mm, 40 grit	10	156

Article number	Description		Pkg. unit	Page
49516	Corundum Grinding Belt (Narrow)	3 x 533 mm, 60 grit	10	156
49518	Corundum Grinding Belt (Narrow)	3 x 533 mm, 80 grit	10	156
49519	Corundum Grinding Belt (Narrow)	3 x 533 mm, 120 grit	10	156
50101	Aluminium Transport Case	Internal dimensions 515 x 330 x 220 mm	1	217
50102	Aluminium Transport Case	Internal dimensions 760 x 350 x 300 mm	1	217
52004-3	QUICK-LOCK Cable (EU)	220 – 240 volts, 4 m long	1	71
52004-3a	QUICK-LOCK Cable (AU)	220 – 240 volts, 4 m long	1	71
52004-3e	QUICK-LOCK Cable (UK)	110 volts, 4 m long	1	71
52004-3s	QUICK-LOCK Cable (CH)	220 – 240 volts, 4 m long	1	71
52004-3u	QUICK-LOCK Cable (US)	120 volts, 4 m long	1	71
52004d	Adapter EU to UK		1	71
52005-3	QUICK-LOCK Cable (EU)	220 – 240 volts, 10 m long	1	71
60080	Hand Fleece	10 m x 100 mm, 80 grit, rolled	1	219
60180	Hand Fleece	10 m x 100 mm, 180 grit, rolled	1	219
60280	Hand Fleece	10 m x 100 mm, 280 grit, rolled	1	219
60400	Hand Fleece	10 m x 100 mm, 400 grit, rolled	1	219
61115	Clean Disc MCD	115 x 10 mm, approx. 13 mm material thickness	10	103
61150	Clean Disc MCD	150 x 10 mm, approx. 13 mm material thickness	10	103
61151	Clamping Shaft for Clean Disc MCD	8 mm steel shaft, for drills and similar	1	103
65000	VARILEX® WSF 1800 Machine (EU)	1750 watts, 220 – 240 volts, incl. Grinding disc and cutting disc	1	69
65000a	VARILEX® WSF 1800 Machine (UK)	1710 watts, 110 volts, incl. Grinding disc and cutting disc	1	69
65000s	VARILEX® WSF 1800 Machine (CH)	1750 watts, 220 – 240 volts, incl. Grinding disc and cutting disc	1	69
65003	FIX TEC Quick Release Nut	M14, 45 mm	1	216
65004	Thin Clamping Nut	M14, 45 mm, 4 mm flat, incl. chuck key	1	216
65005	Height-Adjusting Washer	50 mm, for compensating for the height of the spindle	1	216
65006	M10 to M14 Adapter	Adapts M10 to M14 thread	1	216
65007	Grinding Wheel Mount	for 50 mm wide wheels, 8 mm steel shaft, incl. clamp bolt	1	220
65008	EASYLOCK quick lock Nut	M14, 45 mm	1	216
65008-4	EASYLOCK quick lock Nut	(5/8"), 45 mm	1	216
65020	Special Protective Cover	for VARILEX® WSF 1800, bayonet lock (grinding discs up to 125 mm)	1	71
65021	Special Protective Cover	for VARILEX® WSF 1800, bayonet lock (grinding discs up to 125 mm)	1	71
65022	Special Protective Cover	for VARILEX® WSF 1800, bayonet lock (grinding discs up to 125 mm)	1	71
65023	Protective Cover for cutting	for VARILEX® WSF 1800, bayonet lock (grinding discs up to 125 mm)	1	71
65025	Protective Cover for cutting	for VARILEX® WSF 1800, bayonet lock (grinding discs up to 125 mm)	1	71
65202	VARILEX® WSF 900 DUO Machine	850 watts, 220 – 240 volts, incl. Grinding disc	1	75
65203	VARILEX® WSF 900 DUO Professional Set	850 watts, 220 – 240 volts	1	76
65204	Special Protective Cover	for VARILEX® WSF 900 DUO / 905 (cutting discs up to 125 mm)	1	79
65205	Special Protective Cover	for VARILEX® WSF 900 DUO / 905 (grinding discs up to 125 mm)	1	79
65206	VARILEX® WSF 900 DUO Protection Cover	incl. knurled screws, for linear grinding	1	79
65209	Special Protective Cover	for VARILEX® WSF 900 DUO / 905 (grinding discs up to 125 mm)	1	79
65210	VARILEX® DUO Expansion Roller	90 x 50 mm, M14 mount	1	78
65215	VARILEX® DUO Grinding Belt Roller	85 x 70 mm, M14 mount	1	78
65220	VARILEX® DUO Grinding Wheel Mount	45 x 50 mm, M14 mount	1	79
65501	VARILEX® WSF 905 PROFESSIONAL Machine	850 watts, 220 – 240 volts, incl. Grinding disc	1	81
65502	VARILEX® WSF 905 PROFESSIONAL Metal Set	850 watts, 220 – 240 volts	1	82
80002	POLY-PTX® Professional Transport Case	Sturdy, shockproof, lockable, excl. contents	1	217

Article number	Description		Pkg. unit	Page
80003sv	E-Boxx Case Foam Inlays	Very sturdy, shockproof, lockable, excl. contents	1	217
80050	VARILEX® WSF 1800 Professional Set (EU)	1750 watts, 220 – 240 volts	1	70
80050a	VARILEX® WSF 1800 Professional Set (UK)	1710 watts, 110 volts	1	70
80050s	VARILEX® WSF 1800 Professional Set (CH)	1750 watts, 220 – 240 volts	1	70
80100p	FIX Special Backing Pad	96 mm, M14, hook & loop, centring	1	86
80115p	FIX Special Backing Pad	110 mm, M14, hook & loop, centring	1	86
80120	FIX Soft Damping Adapter	110 mm, harpoon hook & loop	5	86
80123p	FIX Special Backing Pad	119 mm, M14, hook & loop, centring	1	86
80150p	FIX Special Backing Pad	143 mm, M14, centring	1	86
80155	FIX Soft Damping Adapter	150 mm, harpoon hook & loop	5	86
80160p	FIX Special Backing Pad	168 mm, M14, hook & loop, centring	1	86
80222	FIX HellFire®	125 x 10 mm, Multigrain 40/60, hook & loop, flap disc	25	87
80225	FIX HellFire®	150 x 10 mm, Multigrain 40/60, hook & loop, flap disc	25	87
80340	FIX Cool Top®	115 x 10 mm, 40 grit, hook & loop, flap disc	25	87
80360	FIX Cool Top®	115 x 10 mm, 60 grit, hook & loop, flap disc	25	87
80380	FIX Cool Top®	115 x 10 mm, 80 grit, hook & loop, flap disc	25	87
80390	FIX Cool Top®	115 x 10 mm, 120 grit, hook & loop, flap disc	25	87
80440	FIX Cool Top®	125 x 10 mm, 40 grit, hook & loop, flap disc	25	87
80460	FIX Cool Top®	125 x 10 mm, 60 grit, hook & loop, flap disc	25	87
80480	FIX Cool Top®	125 x 10 mm, 80 grit, hook & loop, flap disc	25	87
80490	FIX Cool Top®	125 x 10 mm, 120 grit, hook & loop, flap disc	25	87
80540	FIX Cool Top®	150 x 10 mm, 40 grit, hook & loop, flap disc	25	87
80560	FIX Cool Top®	150 x 10 mm, 60 grit, hook & loop, flap disc	25	87
80580	FIX Cool Top®	150 x 10 mm, 80 grit, hook & loop, flap disc	25	87
80590	FIX Cool Top®	150 x 10 mm, 120 grit, hook & loop, flap disc	25	87
80605	FIX SC Fleece Disc	100 x 10 mm, coarse, hook & loop	20	90
80606	FIX SC Fleece Disc	100 x 10 mm, medium, hook & loop	20	90
80607	FIX SC Fleece Disc	100 x 10 mm, fine, hook & loop	20	90
80613	FIX SC Fleece Disc	115 x 10 mm, 1FOR2 extra coarse, hook & loop	10	90
80615	FIX SC Fleece Disc	115 x 10 mm, coarse, hook & loop	20	90
80616	FIX SC Fleece Disc	115 x 10 mm, medium, hook & loop	20	90
80617	FIX SC Fleece Disc	115 x 10 mm, fine, hook & loop	20	90
80618	FIX SC Fleece Disc	115 x 10 mm, superfine, hook & loop	20	90
80624	FIX SC Fleece Disc	125 x 10 mm, 1FOR2 extra coarse, hook & loop	10	90
80625	FIX SC Fleece Disc	125 x 10 mm, coarse, hook & loop	20	90
80626	FIX SC Fleece Disc	125 x 10 mm, medium, hook & loop	20	90
80627	FIX SC Fleece Disc	125 x 10 mm, fine, hook & loop	20	90
80649	FIX SC Fleece Disc	150 x 10 mm, 1FOR2 extra coarse, hook & loop	10	90
80650	FIX SC Fleece Disc	150 x 10 mm, coarse, hook & loop	20	90
80651	FIX SC Fleece Disc	150 x 10 mm, medium, hook & loop	20	90
80652	FIX SC Fleece Disc	150 x 10 mm, fine, hook & loop	20	90
80653	FIX SC Fleece Disc	150 x 10 mm, superfine, hook & loop	20	90
80670	FIX SC Fleece Disc	178 x 10 mm, coarse, hook & loop	20	90
80671	FIX SC Fleece Disc	178 x 10 mm, medium, hook & loop	20	90
80672	FIX SC Fleece Disc	178 x 10 mm, fine, hook & loop	20	90
80680	FIX AluPolish	115 x 10 mm, superfine, hook & loop	10	89

Article number	Description		Pkg. unit	Page
80690	FIX AluPolish	150 x 10 mm, superfine, hook & loop	10	89
80705	FIX Felt Disc	100 x 10 mm, hook & loop, merino	10	93
80715	FIX Felt Disc	115 x 10 mm, hook & loop, merino	10	93
80715n	FIX SuperPolish Disc	115 x 10 mm, hook & loop	10	93
80718	FIX BRIGHTEX® Berry Polishing Disc	115 x 10 mm, hook & loop	10	92
80719	FIX BRIGHTEX® Sun Polishing Disc	115 x 10 mm, hook & loop	10	92
80725	FIX Felt Disc	125 x 10 mm, hook & loop, merino	10	93
80725n	FIX SuperPolish Disc	125 x 10 mm, hook & loop	10	93
80728	FIX BRIGHTEX® Berry Polishing Disc	125 x 10 mm, hook & loop	10	92
80729	FIX BRIGHTEX® Sun Polishing Disc	125 x 10 mm, hook & loop	10	92
80750	FIX Felt Disc	150 x 10 mm, hook & loop, merino	10	93
80750n	FIX SuperPolish Disc	150 x 10 mm, hook & loop	10	93
80753	FIX BRIGHTEX® Berry Polishing Disc	150 x 10 mm, hook & loop	10	92
80754	FIX BRIGHTEX® Sun Polishing Disc	150 x 10 mm, hook & loop	10	92
80770	FIX Felt Disc	178 x 10 mm, hook & loop, merino	10	93
80770n	FIX SuperPolish Disc	178 x 10 mm, hook & loop	10	93
80773	FIX BRIGHTEX® Berry Polishing Disc	178 x 10 mm, hook & loop	10	92
80774	FIX BRIGHTEX® Sun Polishing Disc	178 x 10 mm, hook & loop	10	92
80810	FIX Fleece Top	115 x 10 mm, grit 80, hook & loop	5	89
80811	FIX Fleece Top	115 x 10 mm, grit 180, hook & loop	5	89
80812	FIX Fleece Top	115 x 10 mm, grit 280, hook & loop	5	89
80813	FIX Fleece Top	115 x 10 mm, grit 400, hook & loop	5	89
80814	FIX Fleece Top	115 x 10 mm, grit 600, hook & loop	5	89
80815	FIX Fleece Top	115 x 10 mm, grit 900, hook & loop	5	89
80900	FIX Clean Disc	150 x 10 mm, approx. 13 mm material thickness, hook & loop	5	88
80901	FIX Clean Disc	115 x 10 mm, approx. 13 mm material thickness, hook & loop	5	88
80904	FIX Zirconium Disc	115 x 10 mm, 40 grit, hook & loop	50	88
80906	FIX Zirconium Disc	115 x 10 mm, 60 grit, hook & loop	50	88
80908	FIX Zirconium Disc	115 x 10 mm, 80 grit, hook & loop	50	88
80909	FIX Zirconium Disc	115 x 10 mm, 120 grit, hook & loop	50	88
80914	FIX Zirconium Disc	150 x 10 mm, 40 grit, hook & loop	50	88
80916	FIX Zirconium Disc	150 x 10 mm, 60 grit, hook & loop	50	88
80918	FIX Zirconium Disc	150 x 10 mm, 80 grit, hook & loop	50	88
80919	FIX Zirconium Disc	150 x 10 mm, 120 grit, hook & loop	50	88
80930	FIX Trizact™ Disc	115 x 10 mm, 120 / A 160 grit, hook & loop	10	91
80931	FIX Trizact™ Disc	115 x 10 mm, 220 / A 100 grit, hook & loop	10	91
80932	FIX Trizact™ Disc	115 x 10 mm, 280 / A 65 grit, hook & loop	10	91
80940	FIX Trizact™ Disc	115 x 10 mm, 400 / A 45 grit, hook & loop	10	91
80960	FIX Trizact™ Disc	115 x 10 mm, 600 / A 30 grit, hook & loop	10	91
80970	FIX Trizact™ Disc	115 x 10 mm, 1200 / A 16 grit, hook & loop	10	91
80980	FIX Trizact™ Disc	115 x 10 mm, 2000 / A 06 grit, hook & loop	10	91
80983	FIX Trizact™ Disc	150 x 10 mm, 120 / A 160 grit, hook & loop	10	91
80984	FIX Trizact™ Disc	150 x 10 mm, 220 / A 100 grit, hook & loop	10	91
80985	FIX Trizact™ Disc	150 x 10 mm, 280 / A 65 grit, hook & loop	10	91
80986	FIX Trizact™ Disc	150 x 10 mm, 400 / A 45 grit, hook & loop	10	91
80987	FIX Trizact™ Disc	150 x 10 mm, 600 / A 30 grit, hook & loop	10	91



Article number	Description		Pkg. unit	Page
80988	FIX Trizact™ Disc	150 x 10 mm, 1200 / A 16 grit, hook & loop	10	91
80989	FIX Trizact™ Disc	150 x 10 mm, 2000 / A 06 grit, hook & loop	10	91
82001	COLDSTEEL® Backing Plate	113 mm, M14 thread, for fibre discs	1	53
82002	COLDSTEEL® Backing Plate	113 mm, 5/8" thread, for fibre discs	1	53
82004	COLDSTEEL® Ceramic	115 x 22.2 mm, 36 grit, fibre disc	25	52
82007	COLDSTEEL® Ceramic	115 x 22.2 mm, 60 grit, fibre disc	25	52
82008	COLDSTEEL® Ceramic	115 x 22.2 mm, 80 grit, fibre disc	25	52
82009	COLDSTEEL® Ceramic	115 x 22.2 mm, 120 grit, fibre disc	25	52
82011	COLDSTEEL® Backing Plate	123 mm, M14 thread, for fibre discs	1	53
82012	COLDSTEEL® Backing Plate	123 mm, 5/8" thread, for fibre discs	1	53
82013	COLDSTEEL® Ceramic	125 x 22.2 mm, 24 grit, fibre disc	25	52
82014	COLDSTEEL® Ceramic	125 x 22.2 mm, 36 grit, fibre disc	25	52
82017	COLDSTEEL® Ceramic	125 x 22.2 mm, 60 grit, fibre disc	25	52
82018	COLDSTEEL® Ceramic	125 x 22.2 mm, 80 grit, fibre disc	25	52
82019	COLDSTEEL® Ceramic	125 x 22.2 mm, 120 grit, fibre disc	25	52
82021	COLDSTEEL® Backing Plate	173 mm, M14 thread, for fibre discs	1	53
82022	COLDSTEEL® Backing Plate	173 mm, 5/8" thread, for fibre discs	1	53
82023	COLDSTEEL® Ceramic	180 x 22.2 mm, 24 grit, fibre disc	25	52
82024	COLDSTEEL® Ceramic	180 x 22.2 mm, 36 grit, fibre disc	25	52
82027	COLDSTEEL® Ceramic	180 x 22.2 mm, 60 grit, fibre disc	25	52
82028	COLDSTEEL® Ceramic	180 x 22.2 mm, 80 grit, fibre disc	25	52
82029	COLDSTEEL® Ceramic	180 x 22.2 mm, 120 grit, fibre disc	25	52
85111	MAGNUM® FINECUT	115 x 22.2 mm, 1.0 mm thick, cutting disc	25	25
85112	MAGNUM® FINECUT	125 x 22.2 mm, 1.0 mm thick, cutting disc	25	25
85122	MAGNUM® RAZORCUT®	125 x 22.2 mm, 1.0 mm thick, cutting disc	25	24
85312	MAGNUM® FLEXO	125 x 22.2 mm, 6.0 mm thick, rough Grinding disc	10	26
85412	MAGNUM® TWINFLEX®	125 x 22.2 mm, 2.5 mm thick, cutting and rough Grinding disc	25	25
91504	TRIMFIX® ZIRCOPUR®	100 x 16.2 mm, 40 grit, elastic flap disc	40	35
91506	TRIMFIX® ZIRCOPUR®	100 x 16.2 mm, 60 grit, elastic flap disc	40	35
91508	TRIMFIX® ZIRCOPUR®	100 x 16.2 mm, 80 grit, elastic flap disc	40	35
91509	TRIMFIX® ZIRCOPUR®	100 x 16.2 mm, 120 grit, elastic flap disc	40	35
91514	TRIMFIX® ZIRCOPUR®	115 x 22.2 mm, 40 grit, elastic flap disc	40	35
91516	TRIMFIX® ZIRCOPUR®	115 x 22.2 mm, 60 grit, elastic flap disc	40	35
91518	TRIMFIX® ZIRCOPUR®	115 x 22.2 mm, 80 grit, elastic flap disc	40	35
91519	TRIMFIX® ZIRCOPUR®	115 x 22.2 mm, 120 grit, elastic flap disc	40	35
91520	TRIMFIX® HellFire®	100 x 15.2 mm, Multigrain 40/60, elastic flap disc	40	31
91521	TRIMFIX® HellFire®	100 x 16.2 mm, Multigrain 40/60, elastic flap disc	40	31
91524	TRIMFIX® ZIRCOPUR®	125 x 22.2 mm, 40 grit, elastic flap disc	40	35
91526	TRIMFIX® ZIRCOPUR®	125 x 22.2 mm, 60 grit, elastic flap disc	40	35
91528	TRIMFIX® ZIRCOPUR®	125 x 22.2 mm, 80 grit, elastic flap disc	40	35
91529	TRIMFIX® ZIRCOPUR®	125 x 22.2 mm, 120 grit, elastic flap disc	40	35
91530	TRIMFIX® HellFire®	115 x 22.2 mm, Multigrain 40/60, elastic flap disc	40	31
91540	TRIMFIX® HellFire®	125 x 22.2 mm, Multigrain 40/60, elastic flap disc	40	31
91547	TRIMFIX® HellFire®	150 x 22.2 mm, Multigrain 40/60, elastic flap disc	40	31
91549	TRIMFIX® HellFire®	178 x 22.2 mm, Multigrain 40/60, elastic flap disc	40	31
91574	TRIMFIX® ZIRCOPUR®	150 x 22.2 mm, 40 grit, elastic flap disc	40	35

Article number	Description		Pkg. unit	Page
91576	TRIMFIX® ZIRCOPUR®	150 x 22.2 mm, 60 grit, elastic flap disc	40	35
91578	TRIMFIX® ZIRCOPUR®	150 x 22.2 mm, 80 grit, elastic flap disc	40	35
91579	TRIMFIX® ZIRCOPUR®	150 x 22.2 mm, 120 grit, elastic flap disc	40	35
91580	TRIMFIX® ZIRCOPUR®	178 x 22.2 mm, 40 grit, elastic flap disc	40	35
91581	TRIMFIX® ZIRCOPUR®	178 x 22.2 mm, 60 grit, elastic flap disc	40	35
91582	TRIMFIX® ZIRCOPUR®	178 x 22.2 mm, 80 grit, elastic flap disc	40	35
91583	TRIMFIX® ZIRCOPUR®	178 x 22.2 mm, 120 grit, elastic flap disc	40	35
91704	TRIMFIX® BLACK MAMBA®	100 x 16.2 mm, 40 grit, flap disc for steel/INOX	40	33
91706	TRIMFIX® BLACK MAMBA®	100 x 16.2 mm, 60 grit, flap disc for steel/INOX	40	33
91714	TRIMFIX® BLACK MAMBA®	115 x 22.2 mm, 40 grit, flap disc for steel/INOX	40	33
91716	TRIMFIX® BLACK MAMBA®	115 x 22.2 mm, 60 grit, flap disc for steel/INOX	40	33
91724	TRIMFIX® BLACK MAMBA®	125 x 22.2 mm, 40 grit, flap disc for steel/INOX	40	33
91726	TRIMFIX® BLACK MAMBA®	125 x 22.2 mm, 60 grit, flap disc for steel/INOX	40	33
91734	TRIMFIX® BLACK MAMBA®	150 x 22.2 mm, 40 grit, flap disc for steel/INOX	40	33
91736	TRIMFIX® BLACK MAMBA®	150 x 22.2 mm, 60 grit, flap disc for steel/INOX	40	33
91744	TRIMFIX® BLACK MAMBA®	178 x 22.2 mm, 40 grit, flap disc for steel/INOX	40	33
91746	TRIMFIX® BLACK MAMBA®	178 x 22.2 mm, 60 grit, flap disc for steel/INOX	40	33
92140	PLANTEX® Cool Top® Universal	115 x 22.2 mm, 40 grit, elastic flap disc	40	37
92160	PLANTEX® Cool Top® Universal	115 x 22.2 mm, 60 grit, elastic flap disc	40	37
92180	PLANTEX® Cool Top® Universal	115 x 22.2 mm, 80 grit, elastic flap disc	40	37
92190	PLANTEX® Cool Top® Universal	115 x 22.2 mm, 120 grit, elastic flap disc	40	37
92240	PLANTEX® Cool Top® Universal	125 x 22.2 mm, 40 grit, elastic flap disc	40	37
92260	PLANTEX® Cool Top® Universal	125 x 22.2 mm, 60 grit, elastic flap disc	40	37
92280	PLANTEX® Cool Top® Universal	125 x 22.2 mm, 80 grit, elastic flap disc	40	37
92290	PLANTEX® Cool Top® Universal	125 x 22.2 mm, 120 grit, elastic flap disc	40	37
92340	PLANTEX® Cool Top® Universal	178 x 22.2 mm, 40 grit, elastic flap disc	40	37
92360	PLANTEX® Cool Top® Universal	178 x 22.2 mm, 60 grit, elastic flap disc	40	37
92380	PLANTEX® Cool Top® Universal	178 x 22.2 mm, 80 grit, elastic flap disc	40	37
92390	PLANTEX® Cool Top® Universal	178 x 22.2 mm, 120 grit, elastic flap disc	40	37
94140e	BLUE SHARK® Elastic	115 x 22.2 mm, 40 grit, elastic flap disc	40	47
94145e	TIGER SHARK® Elastic	115 x 22.2 mm, 40 grit, elastic flap disc	40	49
94160e	BLUE SHARK® Elastic	115 x 22.2 mm, 60 grit, elastic flap disc	40	47
94165e	TIGER SHARK® Elastic	115 x 22.2 mm, 60 grit, elastic flap disc	40	49
94180e	BLUE SHARK® Elastic	115 x 22.2 mm, 80 grit, elastic flap disc	40	47
94185e	TIGER SHARK® Elastic	115 x 22.2 mm, 80 grit, elastic flap disc	40	49
94190e	BLUE SHARK® Elastic	115 x 22.2 mm, 120 grit, elastic flap disc	40	47
94195e	TIGER SHARK® Elastic	115 x 22.2 mm, 120 grit, elastic flap disc	40	49
94240e	BLUE SHARK® Elastic	125 x 22.2 mm, 40 grit, elastic flap disc	40	47
94245e	TIGER SHARK® Elastic	125 x 22.2 mm, 40 grit, elastic flap disc	40	49
94260e	BLUE SHARK® Elastic	125 x 22.2 mm, 60 grit, elastic flap disc	40	47
94265e	TIGER SHARK® Elastic	125 x 22.2 mm, 60 grit, elastic flap disc	40	49
94280e	BLUE SHARK® Elastic	125 x 22.2 mm, 80 grit, elastic flap disc	40	47
94285e	TIGER SHARK® Elastic	125 x 22.2 mm, 80 grit, elastic flap disc	40	49
94290e	BLUE SHARK® Elastic	125 x 22.2 mm, 120 grit, elastic flap disc	40	47
94295e	TIGER SHARK® Elastic	125 x 22.2 mm, 120 grit, elastic flap disc	40	49
94340	BLUE SHARK® Elastic	178 x 22.2 mm, 40 grit, elastic flap disc	40	47

Article number	Description		Pkg. unit	Page
94345	TIGER SHARK® Elastic	178 x 22.2 mm, 40 grit, elastic flap disc	40	49
94360	BLUE SHARK® Elastic	178 x 22.2 mm, 60 grit, elastic flap disc	40	47
94365	TIGER SHARK® Elastic	178 x 22.2 mm, 60 grit, elastic flap disc	40	49
96140b	MAGNUM® Cool Top® 5	115 x 22.2 mm, 40 grit, high performance disc	40	41
96160b	MAGNUM® Cool Top® 5	115 x 22.2 mm, 60 grit, high performance disc	40	41
96180b	MAGNUM® Cool Top® 5	115 x 22.2 mm, 80 grit, high performance disc	40	41
96190b	MAGNUM® Cool Top® 5	115 x 22.2 mm, 120 grit, high performance disc	40	41
96240b	MAGNUM® Cool Top® 5	125 x 22.2 mm, 40 grit, high performance disc	40	41
96260b	MAGNUM® Cool Top® 5	125 x 22.2 mm, 60 grit, high performance disc	40	41
96280b	MAGNUM® Cool Top® 5	125 x 22.2 mm, 80 grit, high performance disc	40	41
96284	MAGNUM® Fillet Weld	125 x 22.2 mm, 40 grit, special flap disc	10	43
96286	MAGNUM® Fillet Weld	125 x 22.2 mm, 60 grit, special flap disc	10	43
96288	MAGNUM® Fillet Weld	125 x 22.2 mm, 80 grit, special flap disc	10	43
96289	MAGNUM® Fillet Weld	125 x 22.2 mm, 120 grit, special flap disc	10	43
96290b	MAGNUM® Cool Top® 5	125 x 22.2 mm, 120 grit, high performance disc	40	41
96340b	MAGNUM® Cool Top® 5	178 x 22.2 mm, 40 grit, high performance disc	40	41
96360b	MAGNUM® Cool Top® 5	178 x 22.2 mm, 60 grit, high performance disc	40	41
96380b	MAGNUM® Cool Top® 5	178 x 22.2 mm, 80 grit, high performance disc	40	41
96464	MAGNUM® Cool Top® 8	115 x 22.2 mm, 40 grit, high performance disc	40	39
96466	MAGNUM® Cool Top® 8	115 x 22.2 mm, 60 grit, high performance disc	40	39
96468	MAGNUM® Cool Top® 8	115 x 22.2 mm, 80 grit, high performance disc	40	39
96469	MAGNUM® Cool Top® 8	115 x 22.2 mm, 120 grit, high performance disc	40	39
96474	MAGNUM® Cool Top® 8	125 x 22.2 mm, 40 grit, high performance disc	40	39
96476	MAGNUM® Cool Top® 8	125 x 22.2 mm, 60 grit, high performance disc	40	39
96478	MAGNUM® Cool Top® 8	125 x 22.2 mm, 80 grit, high performance disc	40	39
96479	MAGNUM® Cool Top® 8	125 x 22.2 mm, 120 grit, high performance disc	40	39
96494	MAGNUM® Cool Top® 8	178 x 22.2 mm, 40 grit, high performance disc	40	39
96496	MAGNUM® Cool Top® 8	178 x 22.2 mm, 60 grit, high performance disc	40	39
96498	MAGNUM® Cool Top® 8	178 x 22.2 mm, 80 grit, high performance disc	40	39
96499	MAGNUM® Cool Top® 8	178 x 22.2 mm, 120 grit, high performance disc	40	39
96614	MAGNUM® Ceramic	115 x 22.2 mm, 40 grit, high performance disc	40	45
96616	MAGNUM® Ceramic	115 x 22.2 mm, 60 grit, high performance disc	40	45
96618	MAGNUM® Ceramic	115 x 22.2 mm, 80 grit, high performance disc	40	45
96624	MAGNUM® Ceramic	125 x 22.2 mm, 40 grit, high performance disc	40	45
96626	MAGNUM® Ceramic	125 x 22.2 mm, 60 grit, high performance disc	40	45
96628	MAGNUM® Ceramic	125 x 22.2 mm, 80 grit, high performance disc	40	45
96644	MAGNUM® Ceramic	178 x 22.2 mm, 40 grit, high performance disc	40	45
96646	MAGNUM® Ceramic	178 x 22.2 mm, 60 grit, high performance disc	40	45
96648	MAGNUM® Ceramic	178 x 22.2 mm, 80 grit, high performance disc	40	45
96700	MAGNUM® Clean	125 x 22.2 mm, approx. 13 mm material thickness	5	66
96705	MAGNUM® Top Mix	125 x 22.2 mm, 80 grit	5	58
96710	MAGNUM® Fleece Top	115 x 22.2 mm, 80 grit	5	57
96711	MAGNUM® Fleece Top	115 x 22.2 mm, 180 grit	5	57
96712	MAGNUM® Fleece Top	115 x 22.2 mm, 280 grit	5	57
96713	MAGNUM® Fleece Top	115 x 22.2 mm, 400 grit	5	57
96714	MAGNUM® Fleece Top	115 x 22.2 mm, 600 grit	5	57

Article number	Description		Pkg. unit	Page
96715	MAGNUM® Fleece Top	115 x 22.2 mm, 900 grit	5	57
96720	MAGNUM® Poly Magic Wheel	6 x 22.2 mm, 80 grit, pre-finishing	5	59
96721	MAGNUM® Poly Magic Wheel	6 x 22.2 mm, 900 grit, finishing	5	59
96740	TRIMFIX® Fleece Flap 1FOR2	125 x 22.2 mm, extra coarse	10	55
96741	TRIMFIX® Fleece Flap 1FOR2	125 x 22.2 mm, coarse	10	54
96742	TRIMFIX® Fleece Flap	125 x 22.2 mm, medium	10	54
96743	TRIMFIX® Fleece Flap	125 x 22.2 mm, fine	10	54
96770	MAGNUM® Unitized	127 x 3.2 x 22.2 mm, hardness: hard, result 180-220 grit	5	60
96771	MAGNUM® Unitized	127 x 3.2 x 22.2 mm, hardness: soft, result 240-280 grit	5	60
96772	MAGNUM® Unitized	127 x 6.3 x 22.2 mm, hardness: hard, result 180-220 grit	5	60
96773	MAGNUM® Unitized	127 x 6.3 x 22.2 mm, hardness: soft, result 240-280 grit	5	60
96775	MAGNUM® Unitized	152 x 3.2 x 25.4 mm, hardness: hard, result 180-220 grit	5	60
96776	MAGNUM® Unitized	152 x 3.2 x 25.4 mm, hardness: soft, result 180-220 grit	5	60
96777	MAGNUM® Unitized	152 x 6.3 x 25.4 mm, hardness: hard, result 180-220 grit	5	60
96778	MAGNUM® Unitized	152 x 6.3 x 25.4 mm, hardness: soft, result 240-280 grit	5	60







EISENBLÄTTER



EISENBLÄTTER



EISENBLÄTTER



EISENBLÄTTER



EISENBLÄTTER



EISENBLÄTTER



EISENBLÄTTER



EISENBLÄTTER



EISENBLÄTTER



EISENBLÄTTER



EISENBLÄTTER

#### TRADEMARKS

EISENBLÄTTER · BLUE SHARK · BRIGHTEX  
COLD STEEL · COOL TOP · BLACK MAMBA  
GLADIUS · MAGNUM · MINI MAX · PLANTEX  
PLATINUM · POLY-PTX · RAZORCUT · ROHR FIX  
ROHR MAX · SNIPER · TIGER SHARK · TRIMFIX  
TRIMTEX · TWINFLEX · VARILEX · ZIRCOPUR  
ZIRCOTEX · HELLFIRE



**EISENBLÄTTER**  
Simply better ideas.

ARE REGISTERED TRADEMARKS  
OF EISENBLÄTTER

---

**PRESENTED BY:**

**www.eisenblaetter.de**

Gerd Eisenblätter GmbH | Jeschkenstraße 12d | DE - 82538 Geretsried | Phone +49 8171 9082-010 | Fax +49 8171 9082-220  
www.eisenblaetter.de | www.eisenblaetter.tools | info@eisenblaetter.de

