

- 1
- 2
- 3
- 4
- 5
- 6
- 7
- 8
- 9
- 10
- 11
- 12
- 13
- 14
- 15
- RH

**BASE AND CASE**

High-resistance polyamide based (PA) technopolymer. Black base.

Case in the following colours:

- **C2**: RAL 2004 orange, glossy finish.
- **C3**: RAL 7035 grey, glossy finish.
- **C1**: RAL 7021 grey-black, glossy finish.

The ultrasonic welding between the base and the case prevents separation and avoids dust penetration.

**WINDOW**

Transparent polyamide based (PA-T) technopolymer, moulded over the case and with a perfect seal. Resistant to solvents, oils, greases and other chemical agents (avoid contact with alcohol during cleaning operations).

**DISPLAY**

It indicates the displacement of the mechanism controlled by the spindle from the start position (0).

Five-digit roller counter (four black rolls and one red roll or three black rolls and two red rolls). The digits of red rolls show the decimal values. An additional graduated scale next to the last decimal digit offers further accuracy of reading.

The display can be in different positions (see "Table of the possible combinations").

- **AN**: inclined display, counter in upper position.
- **AR**: inclined display, counter in lower position.
- **FN**: front display, counter in upper position.
- **FR**: front display, counter in lower position.

**INTERNAL GASKET**

O-ring front sealing in NBR synthetic rubber, between the case and the boss.

**REAR GASKET**

Foam polyethylene, supplied.

**STANDARD EXECUTIONS**

Boss with Ø 20 mm H7 reamed hole, fitting to shaft by means of a grub screw with hexagon socket and cup end, included in the supply.

- **DD52R**: black-oxide steel boss.
- **DD52R-SST**: INOX AISI 303 stainless steel boss.

**DIRECTION OF ROTATION**

- **D**: clockwise. Increasing values with clockwise rotation of the boss.
- **S**: anti-clockwise. Increasing values with anti-clockwise rotation of the boss.

**WEIGHT**

97 grams.

**FEATURES AND APPLICATIONS**

Direct drive digital position indicators can be assembled on passing through spindles in any position to give direct reading of the positioning of a machine component. They are suitable also for motor driven applications (see "Table of the possible combinations").

**ERGONOMY AND DESIGN**

Compact roller counter, ergonomically designed digits for rapid reading. The readability of the counter is increased by the magnifying window.

**ASSEMBLY INSTRUCTIONS**

1. Drill a Ø 6 mm by 10 mm hole in the body of the machine with a 30 mm centre distance from the spindle to fit the rear referring pin.
2. Set the spindle to the start or referring position.
3. Fit the indicator with the zeroed roller counter onto the spindle and make sure that the referring pin fit the hole.
4. Clamp the boss to the spindle by tightening the grub screw with hexagon socket and cup end, according to UNI 5929-85.



ELESA Original design

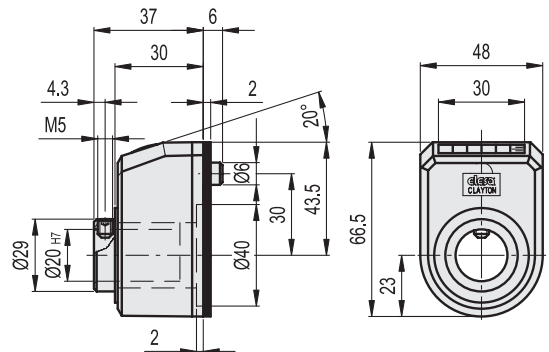





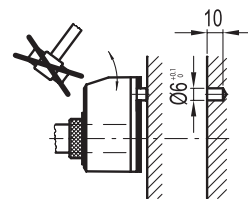
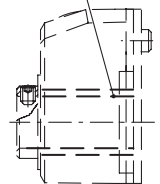
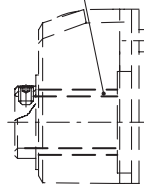





DD52R

DD52R-SST



Position indicators

Example of description for ordering

<b>DD52R</b>	-	<b>AN</b>	-	<b>00001</b>	-	<b>D</b>	-	<b>C2</b>	-	<b>SST</b>
<b>Series</b>		<b>Display position</b>		<b>Reading of the counter after one revolution</b>		<b>Increasing numbering</b>		<b>Colour</b>		<b>Stainless steel boss</b>
 AN		 AR		The internal mechanism counts also the figures between brackets (even if they do not appear on the display).		 D clockwise		 C2 RAL 2004		 To add only for the version with stainless steel boss
 FN		 FR				 S anti-clockwise		 C3 RAL 7035		 C1 RAL 7021

0 0 0 0 1	0 0 0 0 1	0 0 0 0 1	0 0 0 0 1	Pitch	Speed (rpm) *
00001	0000.1	000.01	00.001	0.1	1500
00004	0000.4	000.04	00.004	0.4	1500
00005	0000.5	000.05	00.005	0.5	1500
00009(6)	0000.9(6)	000.09(6)	00.009(6)	0.96	1500
00010	0001.0	000.10	00.010	1.0	1500
00012(5)	0001.2(5)	000.12(5)	00.012(5)	1.25	1500
00015	0001.5	000.15	00.015	1.5	1500
00015(8)	0001.5(8)	000.15(8)	00.015(8)	1.58	1500
00015(75)	0001.5(75)	000.15(75)	00.015(75)	1.575	1500
00016(07)	0001.6(07)	000.16(07)	00.016(07)	1.607	1500
00017(5)	0001.7(5)	000.17(5)	00.017(5)	1.75	1420
00019(6875)	0001.9(6875)	000.19(6875)	00.019(6875)	1.96875	1270
00020	0002.0	000.20	00.020	2.0	1250
00025	0002.5	000.25	00.025	2.5	1000
00025(4)	0002.5(4)	000.25(4)	00.025(4)	2.54	980
00030	0003.0	000.30	00.030	3.0	830
00031(5)	0003.1(5)	000.31(5)	00.031(5)	3.15	790
00031(75)	0003.1(75)	000.31(75)	00.031(75)	3.175	780
00035	0003.5	000.35	00.035	3.5	710
00038(095)	0003.8(095)	000.38(095)	00.038(095)	3.8095	650
00039(375)	0003.9(375)	000.39(375)	00.039(375)	3.9375	640
00040	0004.0	000.40	00.040	4.0	625
00042(9)	0004.2(9)	000.42(9)	00.042(9)	4.29	580
00050	0005.0	000.50	00.050	5.0	500
00050(8)	0005.0(8)	000.50(8)	00.050(8)	5.08	490
00052(94)	0005.2(94)	000.52(94)	00.052(94)	5.294	470
00056(47)	0005.6(47)	000.56(47)	00.056(47)	5.647	440
00060	0006.0	000.60	00.060	6.0	415
00062(5)	0006.2(5)	000.62(5)	00.062(5)	6.25	400
00063(5)	0006.3(5)	000.63(5)	00.063(5)	6.35	390
00066	0006.6	000.66	00.066	6.6	370
00070	0007.0	000.70	00.070	7.0	350
00075	0007.5	000.75	00.075	7.5	330
00076(923)	0007.6(923)	000.76(923)	00.076(923)	7.6923	325
00078(75)	0007.8(75)	00078(75)	00.078(75)	7.875	310
00080	0008.0	000.80	00.080	8.0	315
00090	0009.0	000.90	00.090	9.0	270
00100	0010.0	001.00	00.100	10.0	250
00105	0010.5	001.05	00.105	10.5	235
00118(125)	0011.8(125)	001.18(125)	00.118(125)	11.8125	205
00119(05)	0011.9(05)	001.19(05)	00.119(05)	11.905	210
00120	0012.0	001.20	00.120	12.0	200
00130	0013.0	001.30	00.130	13.0	190
00150	0015.0	001.50	00.150	15.0	160
00160	0016.0	001.60	00.160	16.0	150
00200	0020.0	002.00	00.200	20.0	125

\* The maximum rotation speed (rpm) of the spindle reported in the table corresponds to a maximum rotation of 25000 units of the last roll on the right of the counter.

Rotational speed tests have been performed in our laboratory under standard operating conditions. Small misalignments (not compromising the correct reading) of counter digits can occur due to high tolerances between gear teeth, designed to prevent damage from sudden acceleration or stop.

- 1 
- 2 
- 3 
- 4 
- 5 
- 6 
- 7 
- 8 
- 9 
- 10 
- 11 
- 12 
- 13 
- 14 
- 15 
- RH 

Position indicators



**SPECIAL EXECUTIONS ON REQUEST**

- Special readings after one revolution.
- Case in different colours.
- Completely sealed digital position indicators with IP 67 protection class, see table EN 60529 (on page A-19) obtained by means of a brass bushing with double seal ring inside the rear cavity of the base.

**ACCESSORIES ON REQUEST (TO BE ORDERED SEPARATELY)**

- **BSA52:** zinc die-cast bases for spindle locking, epoxy resin coating, black colour, matte finish (see table). Type GN 302 adjustable handle. BSA52 locking bases allow an easy and quick locking of the spindles after their positioning. They are equipped with a  $\varnothing 6.1$  mm hole to fit the referring pin of the indicator. They can be assembled with the handle either on the right or on the left and can be fitted to the machine by means of two M5 cylindrical-head screws (not included in the supply).

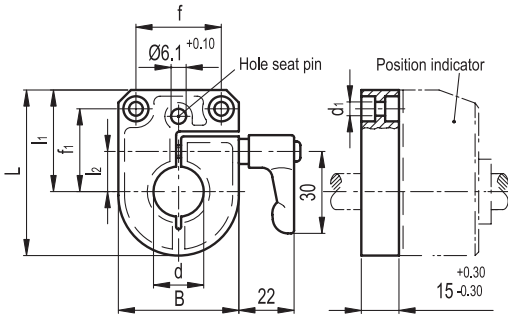

Code	Description	B	L	f	f1	l1	l2	d	d1	⚖️
CE.87901	BSA52-12	48	67	34	33.6	43.1	16	12	5.5	165
CE.87903	BSA52-14	48	67	34	33.6	43.1	16	14	5.5	164
CE.87904	BSA52-15	48	67	34	33.6	43.1	16	15	5.5	163
CE.87905	BSA52-16	48	67	34	33.6	43.1	16	16	5.5	162
CE.87909	BSA52-20	48	67	34	33.6	43.1	16	20	5.5	160

- **RB52:** black-oxide steel reduction sleeves.
- **RB52-SST:** AISI 304 stainless steel reduction sleeves.

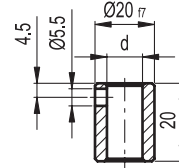

**RB52**

Code	Description	dH7
CE.87940	RB52-12	12
CE.87950	RB52-14	14
CE.87955	RB52-15	15
CE.87960	RB52-16	16



**RB52-SST**

Code	Description	dH7
CE.97941	RB52-12-SST-304	12
CE.97951	RB52-14-SST-304	14
CE.97956	RB52-15-SST-304	15
CE.97961	RB52-16-SST-304	16

- **PE.6-10:** red technopolymer pin (code CE.83960).

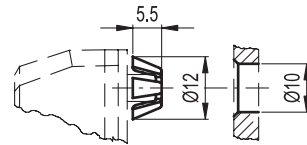

- **BS52R:** glass-fibre reinforced polyamide based (PA) technopolymer spacer base (code CE.83950), designed with two pre-drilled holes for UNI 10227 self-tapping screws  $\varnothing 2.2$  (not included in the supply).

