

Fuji Electric FA Components & Systems Co., Ltd.

Pushbuttons, Pilot lights: AH164, 165, 165-2 series

Sales distributors **AMERICAS** **EUROPE** **ASIA/MiddleEast** **CHINA** **JAPAN**
[Explanation of regional icons](#)

Panel cutout 16mm, easy replacement and adding of contacts



The 16mm dia. series of compact size pushbuttons are 'finger-size', and consequently take up little panel space. AH165-2 series operators are about twice as large as the AH164 and AH165 series operators for easier operation. With many types of operator available, the most suitable switch can be identified by color, shape and legend, and have a smooth, quality "snap-action". In spite of their small size they have a highly reliable mechanism, and are eminently suited for solid state and other electronic circuits.

AH164 and AH165

AH165-2

UL508

UL508

CSA C22.2 No.14

CSA C22.2 No.14

TÜV: EN60947-5-1

TÜV: EN60947-5-1

EN60947-5-5 (Emergency pushbutton)

CCC:GB14048.5

CCC:GB14048.5

<p>FeLibrary Documentation downloads</p>	<p>Information of product change</p>	<p>Search for Discontinued Products</p>
---	---	--

[FAQ](#)

Product Description

Feature	Types and ratings	Dimensions	Type number nomenclature
---------	-------------------	-------------------	--------------------------

Illuminated pushbutton switch/without transformer AH164-L□, AH165-L□

L, L5

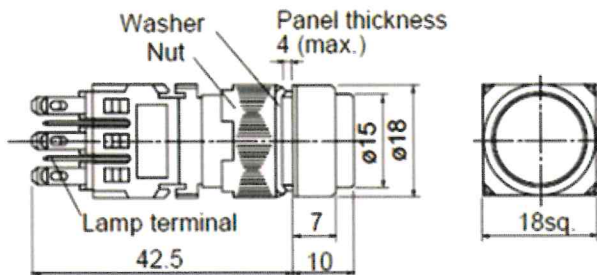

Illuminated pushbutton switch/with transformer AH164-L□, AH165-L□

L, L5

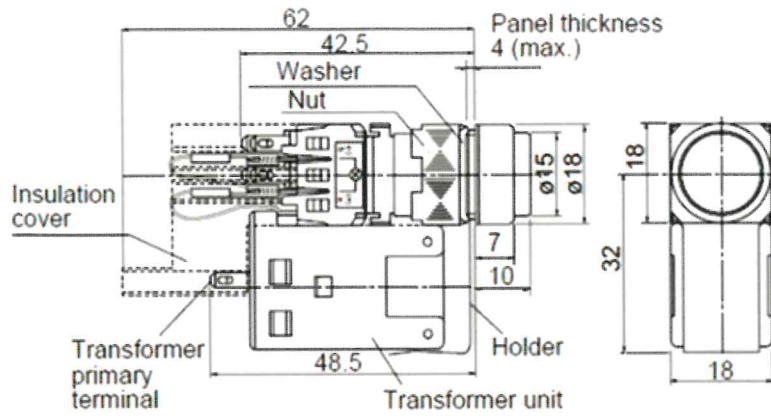

Pushbutton switch AH164-TF□, AH165-TF□

Pushbutton switch/ Push-lock, turn-reset AH164-VR□, AH165-VR□

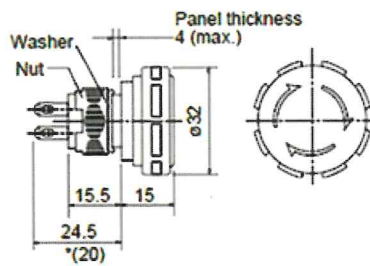
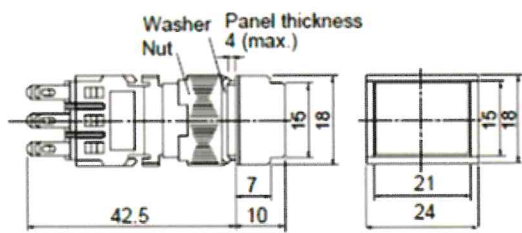

Pilot light/without transformer AH164-Z□, AH165-Z□

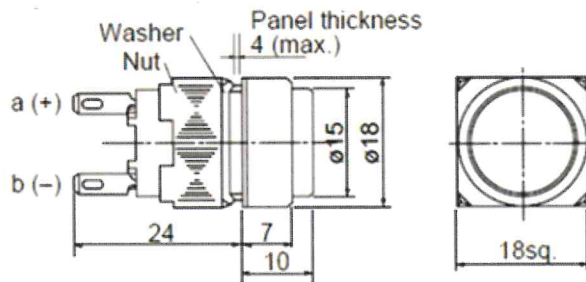

Pilot light/with transformer AH164-Z□, AH165-Z□

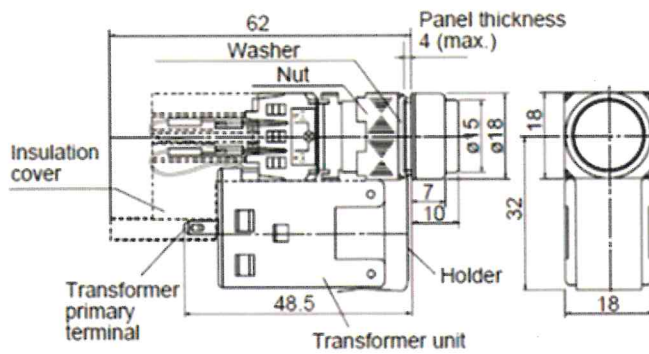

Selector switch/2-position AH164-P□, AH165-P□

Selector switch with key/2-position AH164-J□, AH165-J□

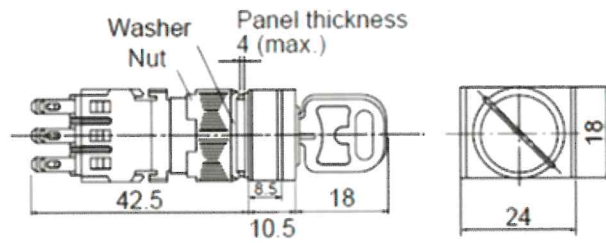
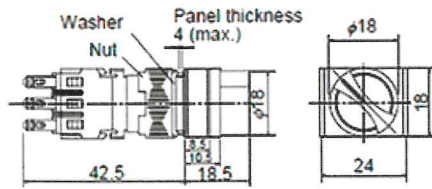

Buzzer AH164-TX2B

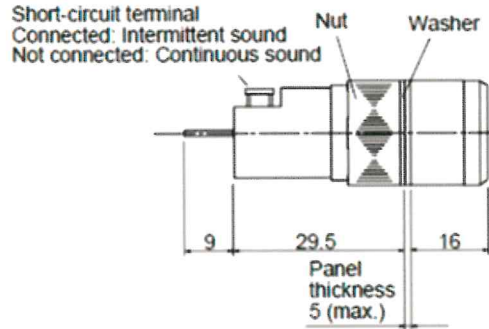

Volume
 Clockwise:
 Increase sound pressure
 Counterclockwise:
 Decrease sound pressure

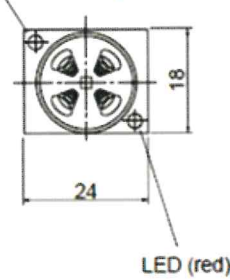

**Illuminated pushbutton switch
 AH165-2FL□/AH165-2F□**

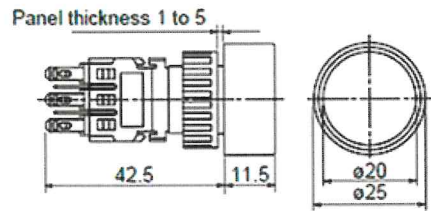

**Illuminated pushbutton switch/
 Push-lock, turn-reset AH165-2VL□/AH165-2V□**

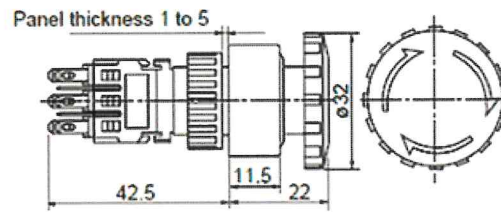

Selector switch AH165-2P

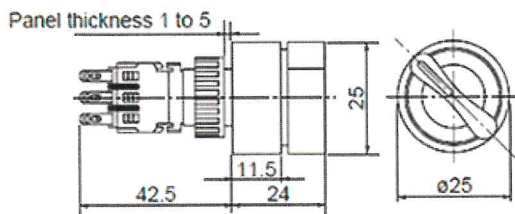

Pilot light AH165-2Z

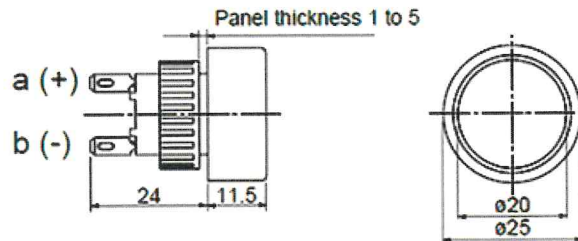

Emergency stop pushbutton switch AH165-V5

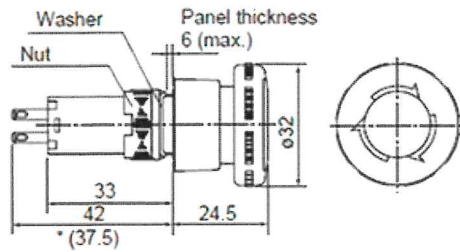

Notes: * () For switch with solder terminal.

Contact about this product

[Contact Us](#)

© Fuji Electric FA Components & Systems Co., Ltd. All Rights Reserved.



AH164, AH165, AH165-2시리즈 기종 일람

I. AH164(폐쇄형) · AH165(방유형)시리즈

■ 조광 푸시 버튼 스위치

명칭	환출형 (Ø18)				각평형 (□18)			
복귀 방식	모멘터리	알터네이트	모멘터리	알터네이트	모멘터리	알터네이트	모멘터리	알터네이트
형식	AH164-L	AH164-L5	AH165-L	AH165-L55	AH164-SL	AH164-SL5	AH165-SL	AH165-SL5
외관								
해외 규격 취득								
조작부 보호구조	IP40 (폐쇄형)		IP65 (방유형)		IP40 (폐쇄형)		IP65 (방유형)	

명칭	장각평형 (18×24)				가드부착 장각평형 (18×24)			
복귀 방식	모멘터리	알터네이트	모멘터리	알터네이트	모멘터리	알터네이트	모멘터리	알터네이트
형식	AH164-TL	AH164-TL5	AH165-TL	AH165-TL5	AH164-TGL	AH164-TGL5	AH165-TGL	AH165-TGL5
외관								
해외 규격 취득								
조작부 보호구조	IP40 (폐쇄형)		IP65 (방유형)		IP40 (폐쇄형)		IP65 (방유형)	

명칭	가드부착 각평형 (□18)			
복귀 방식	모멘터리	알터네이트	모멘터리	알터네이트
형식	AH164-SGL	AH164-SGL5	AH165-SGL	AH165-SGL5
외관				
해외 규격 취득				
조작부 보호구조	IP40 (폐쇄형)		IP65 (방유형)	

(주) 점LED 타입은 해외규격 미취득 사양입니다.

(주) 모멘터리 : 자기복귀
알터네이트 : 자기유지